

# A Complex System Approach to Reliability Analysis of Water Distribution Networks

Seyed Ashkan Zarghami

Entrepreneurship, Commercialisation and Innovation Centre  
Faculty of Professions, University of Adelaide

August 2019

## STATEMENT OF ORIGINALITY

I certify that this work contains no material which has been accepted for the award of any other degree or diploma in my name, in any university or other tertiary institution and, to the best of my knowledge and belief, contains no material previously published or written by another person, except where due reference has been made in the text. In addition, I certify that no part of this work will, in the future, be used in a submission in my name, for any other degree or diploma in any university or other tertiary institution without the prior approval of the University of Adelaide and where applicable, any partner institution responsible for the joint-award of this degree.

I acknowledge that copyright of published works contained within this thesis resides with the copyright holder(s) of those works.

I also give permission for the digital version of my thesis to be made available on the web, via the University's digital research repository, the Library Search and also through web search engines, unless permission has been granted by the University to restrict access for a period of time.

I acknowledge the support I have received for my research through the provision of an Australian Government Research Training Program Scholarship.

**Seyed Ashkan Zarghami**

## Table of Contents

<b>I. ABSTRACT .....</b>	<b>IV</b>
<b>II. ACKNOWLEDGMENTS .....</b>	<b>VI</b>
<b>III. JOURNAL PAPERS RESULTING FROM THIS RESEARCH.....</b>	<b>VIII</b>
<b>IV. CONFERENCE PAPERS RESULTING FROM THIS RESEARCH.....</b>	<b>X</b>
<b>V. PUBLICATIONS NOT INCLUDED IN THIS THESIS.....</b>	<b>XI</b>
<b>VI. AWARDS.....</b>	<b>XII</b>
<b>1. INTRODUCTION .....</b>	<b>1</b>
1.1. Background .....	1
1.2. Research Gaps .....	2
1.3. Research questions .....	4
1.4. Research aims .....	5
1.5. Research significance and innovation .....	6
1.5.1. <i>Theory development</i> .....	6
1.5.2. <i>Practical implications</i> .....	7
1.6. Thesis outline .....	8
<b>2. LITERATURE REVIEW .....</b>	<b>10</b>
2.1. Overview .....	10
2.1.1. <i>Hydraulic reliability analysis</i> .....	10
2.1.2. <i>Topological reliability analysis</i> .....	15
2.2. Paper 1: The four Rs performance indicators of water distribution networks: A review of research literature.....	17
2.3. Paper 2: System dynamics modelling process in water sectors: A review of research literature.....	31
<b>3. RESEARCH DESIGN AND METHODS.....</b>	<b>47</b>
3.1. Tier 1: Reliability analysis based on topological attributes .....	48
3.1.1. <i>Tier 1 Task 1 (T1T1): Probabilistic-based reliability analysis (enabling aim 1)</i> .....	48
3.1.2. <i>Tier 1 Task 2 (T1T2): Importance-based reliability analysis (enabling aim 1)</i> .....	49
3.2. Tier 2: An integrated framework for reliability analysis of WDNs.....	49
3.2.1. <i>Tier 2 Task 1 (T2T1): Coupling probabilistic and importance-based methods (enabling aim 2)</i> .....	49
3.2.2. <i>Tier 2 Task 2 (T2T2): Integrating topological and hydraulic attributes (enabling aim 3)</i> .....	50
3.3. Tier 3: Dynamic modelling for reliability analysis of WDNs.....	51
3.3.1. <i>Tier 3 Task 1 (T3T1): System dynamics modelling for robustness analysis of WDNs (enabling aim 4)</i> .....	51
<b>4. PROBABILISTIC-BASED RELIABILITY ANALYSIS .....</b>	<b>52</b>
4.1. Paper 3: Exact reliability evaluation of infrastructure networks using graph theory .....	52
4.2. Paper 4: Integrating entropy theory and cospanning tree technique for redundancy analysis of water distribution networks.....	77
<b>5. IMPORTANCE-BASED RELIABILITY ANALYSIS .....</b>	<b>89</b>
5.1. Paper 5: Entropy of centrality values for topological vulnerability analysis of water distribution networks.....	89
<b>6. COUPLING PROBABILISTIC AND IMPORTANCE-BASED RELIABILITY ANALYSIS .....</b>	<b>104</b>
6.1. Paper 6: A fuzzy-based vulnerability assessment model for infrastructure networks incorporating reliability and centrality .....	104

<b>7. INTEGRATING TOPOLOGICAL AND HYDRAULIC ATTRIBUTES OF WDNS .....</b>	<b>146</b>
7.1. Paper 7: Integrating topological and hydraulic attributes for robustness analysis of water distribution networks .....	146
7.2. Paper 8: A domain-specific measure of centrality for water distribution networks .....	159
<b>8. APPLICATION OF SYSTEM DYNAMICS MODELLING APPROACH TO WDNS .....</b>	<b>175</b>
8.1. Paper 9: System dynamics modelling approach for robustness analysis of water distribution networks .....	175
<b>9. CONCLUSION .....</b>	<b>203</b>
9.1. Research Outcomes .....	203
9.2. Research Findings .....	204
9.3. Research Contributions.....	206
9.3.1. Tier 1 Task 1 (T1T1): Probabilistic-based reliability analysis	206
9.3.2. Tier 1 Task 2 (T1T2): Importance-based reliability analysis	206
9.3.3. Tier 2 Task 1 (T2T1): Coupling probabilistic and importance-based methods	206
9.3.4. Tier 2 Task 2 (T2T2): Integrating topological and hydraulic attributes	207
9.3.5. Tier 3 Task 1 (T3T1): System dynamics modelling for robustness analysis of WDNs	207
9.4. Limitations of this Research and the Future of Reliability Analysis of WDNs .....	207
<b>REFERENCES .....</b>	<b>209</b>

## **I. Abstract**

Water Distribution Networks (WDNs) are confronted with numerous operational threats that lead to disruption and dysfunction of their performance. As a response to the growing operational dysfunctions, researchers have recognised the importance of using reliability theory to examine the ability of WDNs to provide continuity in operation. However, the current approaches to reliability analysis of these networks mainly focus on one aspect of the reliability problem and fail to provide a complete representation of all factors involved in reliability analysis. These methods are embedded in capturing either the topological properties or the hydraulic attributes of WDNs. On one hand, the hydraulic-based approaches yield insufficient information as to the structural complexity and the level of interaction among components. On the other hand, the existing topological-based approaches just capture very generic topological properties and ignore various hydraulic attributes of WDNs such as demand and pressure head. Furthermore, the conventional reliability analysis methods are only effective for demonstrating a snapshot of these networks at a given point in time and ignore the variation in the parameters involved in the reliability analysis.

This thesis attempts to fill these gaps by generating new knowledge in the area of reliability analysis of WDNs through using a combination of scientific approaches. This includes reliability engineering, system thinking, network theory, probabilistic analysis and hydraulic engineering. It is in this spirit that this research introduces a three-tiered approach. Tier 1 is explicitly tied to evaluate the topological reliability of WDNs. Tier 2 will be developed based on the results of Tier 1, aimed at establishing an integrated framework for reliability analysis.

Tier 3 will use the outputs generated by tier 2 and will attempt to capture the dynamic nature of WDNs.

In attempting to develop a comprehensive reliability assessment model, the present thesis proposes a number of novel reliability analysis methods for WDNs. Using three case studies from the literature as well as four real-world WDNs of Australian towns, this thesis demonstrates the effectiveness of the proposed methods.

This research provides two types of implications. For theory development, it offers new insight and interpretation into the reliability analysis of WDNs by integrating a broad spectrum of various approaches. For water engineering management, the predictive maintenance strategy based on the reliability assessment model proposed here will provide an expert facilitator that helps water service providers to establish and implement a cost-effective maintenance strategy, which relies on identifying and prioritising the vulnerabilities, thereby reducing expenditures on the maintenance activities.

### **II. Acknowledgments**

This Doctoral research was accomplished under the supervisions of Associate Professor Indra Gunawan and Professor Frank Schultmann. It is highly appreciating and grateful for their support, guidance and professional advice.

I first would like to thank Indra for all he has taught me as his PhD student. The knowledge and insight he has imparted upon me over the past three years have been a great support throughout my PhD study. As a result of his expert contribution, I have now much deeper understanding of the nature of research that has helped me to raise my research profile. His ability to maintain a pleasant and high trust relationship has made my association with him very memorable. I feel fortunate and appreciative for being one of the many students that he has positively influenced.

I also want to express my deepest gratitude to Frank for his advice, encouragement and moral support, which definitely have been critical ingredients in this study. Despite having a tremendously busy schedule, Frank never had any scarcity of time to provide advice as I completed this research. I would also like to express my appreciation to Frank for giving me the opportunity to meet and collaborate with his team at the Karlsruhe Institute of Technology (KIT).

I wish to acknowledge the generous support provided by staff members at the Entrepreneurship Commercialisation and Innovation Centre (ECIC) at the University of Adelaide. I would like to extend particular thanks to the Project Management team at ECIC, especially Dr Graciela Corral de Zubielqui, Dr Sam Baroudi and Dr Carmen Reaiche for their support throughout the

## Acknowledgments

---

development of my Doctoral research. I am indebted to them for everything that they have done for me.

I want to thank PhD coordinator and advisor at ECIC, Dr Scott Gordon and Dr Barry Elsey, for their organisational supports, fruitful comments and suggestions, and for honouring me by their presence at my milestone research presentations.

Finally, appreciation is extended to all ECIC students, with whom I have shared so many good moments. Sharing a friendly office with them has been one of the best experience in my PhD study.



### III. Journal Papers Resulting From This Research

#### **Paper 1 (Chapter 2):**

Gunawan, I., Schultmann, F., and **Zarghami, S.A.** 2017. The four Rs performance indicators of water distribution networks. *International Journal of Reliability and Quality Management*. 34(5):720-732.

#### **Paper 2 (Chapter 2):**

**Zarghami, S.A.**, Gunawan, I., and Schultmann, F. 2018. System Dynamic modelling process in water sector: A review of research literature. *System Research and Behavioral Science*. 35(6):776-790.

#### **Paper 3 (Chapter 4):**

**Zarghami, S.A.**, Gunawan, I., and Schultmann, F. 2018. Exact reliability evaluation of infrastructure networks using graph theory. *Quality and Reliability Engineering International*. Under review.

#### **Paper 4 (Chapter 4):**

**Zarghami, S.A.**, Gunawan, I., and Schultmann, F. 2018. Integrating entropy theory and cospanning tree technique for redundancy analysis of water distribution networks. *Reliability Engineering and System Safety*. 176 (2018): 102-112.

#### **Paper 5 (Chapter 5):**

**Zarghami, S.A.**, Gunawan, I., and Schultmann, F. 2019. Entropy of centrality values for topological vulnerability analysis of water distribution networks. *Built Environment Project and Asset Management*. 9 (3): 412-425.

### **Paper 6 (Chapter 6):**

**Zarghami, S.A.**, and Gunawan, I. 2019. A fuzzy-based vulnerability assessment model for infrastructure networks incorporating reliability and centrality. *Engineering, Construction and Architectural Management*. Under review.

### **Paper 7 (Chapter 7):**

**Zarghami, S.A.**, Gunawan, I., and Schultmann, F. 2018. Integrating topological and hydraulic attributes for robustness analysis of water distribution networks. *International Journal of Industrial Engineering and Operations Management*. **1** (1).

### **Paper 8 (Chapter 7):**

**Zarghami, S.A.**, and Gunawan, I. 2019. A domain-specific measure of centrality for water distribution networks. *Engineering, Construction and Architectural Management*. DOI: 10.1108/ECAM-03-2019-0176

### **Paper 9 (Chapter 8):**

**Zarghami, S.A.**, and Gunawan, I. 2019. System dynamics modeling for robustness analysis of water distribution networks. *Reliability Engineering and System Safety*. Under review.

#### **IV. Conference Papers Resulting From This Research**

##### **Conference Paper 1:**

**Zarghami, S.A.**, Gunawan, I., and Schultmann, F. 2018. Measuring robustness of water distribution networks using informational entropy. In proceedings of *8<sup>th</sup> International Conference on Industrial Engineering and Operations Management, Bandung, Indonesia*: 3331-3339.

##### **Conference Paper 2:**

**Zarghami SA**, Gunawan I., Schultmann F. 2018. Vulnerability Analysis of Water Distribution Networks Using Betweenness Centrality and Information Entropy. In Proceedings of *2nd IEOM European Conference on Industrial Engineering and Operations Management, Paris, France*: 1811-1820.

##### **Conference Paper 3:**

**Zarghami SA**, Gunawan I., Schultmann F. 2019. The methods used for reliability analysis of water distribution networks: Past, present, and future. In *2019 International Conference on Resource Sustainability- Cities, Adelaide, Australia*.

##### **Conference Paper 4:**

**Zarghami SA**, Gunawan I., Schultmann F. 2018. The application of graph theory to public infrastructure asset management. In Proceedings of *2019 World Congress on resilience, reliability and asset management, Singapore*.

## V. Publications Not Included In This Thesis

### Journal Papers:

**Zarghami, S.A.**, Gunawan, I., Corral de Zubielqui, G., and Baroudi, B. 2019. Incorporation of resource reliability into critical chain project management buffer sizing. *International Journal of Production Research*. Under review.

Corral de Zubielqui G., **Zarghami, S.A.**, Gorod, A., Gunawan, I., and Reaiche, C. 2019. The current state of complexity theory in entrepreneurship research. *Entrepreneurship Research Journal*. Under review.

### Book Chapter:

**Zarghami, S.A.**, and Gorod, A. 2019. The Evolution of Project Scheduling Tools: Past, Present, and Future. In Gorod A., Hallo L.K., Gunawan, I., and Ireland, V. *An Evolving Toolbox in Complex Project Management*, CRC Press, Taylor & Francis.

## **VI. Awards**

### **Best Higher Degree Research Publication- 2018**

*The University of Adelaide- Entrepreneurship, Commercialisation and Innovation Centre*

### **Research Travel Scholarship- 2018**

*The University of Adelaide*

### **Best Student Research Paper Award- 2017**

*AMPEAK Asset Management Conference- Brisbane*

### **Australian Postgraduate Award (APA)- 2016**

*The University of Adelaide*

# *Chapter 1*

## Introduction

## **1. Introduction**

### **1.1. Background**

The substance of life, water, is an important component of human history. Water-related issues have a history that is almost as long as the dawn of civilization. Most of the great civilizations have settled near convenient sources of water. As a result, the practice of conveying water from these sources for human consumption, what came to be known as Water Distribution Networks (WDNs), has been around for several millennia. In fact, the origins of modern WDNs lie in the urban hydraulic systems at the Bronze Age (3000 BC-1200 BC). The ancient water distribution systems in the Sumerian cities of Eshnunna and Nippur (3000 BC), and the sophisticated system of water supply and sewage in the ancient city of Moenjo-Daro (2600 BC), are the examples of the earliest urban hydraulic systems (Mays *et al.*, 2012).

Since ancient times, WDNs have dictated the living conditions of the human being as well as the economy of human life. However, these networks are exposed to a myriad of operational threats that lead to disruption and dysfunction of their performance. WDNs consist of multiple interconnected interacting components, in which failure of any of these components may lead to system failure. Viewed from this perspective, a WDN serves as a good example of complex systems. The complexity of WDNs along with the extensive societal dependence on these networks emphasise the importance of evaluating the reliability and managing vulnerabilities (Johansson *et al.*, 2013). The reliability of these networks is, therefore, a major concern for researchers and water utilities in ensuring public health, safety, and societal welfare.

The concept of reliability has found its way into evaluating the ability of WDNs to provide continuity of operations. A completely satisfactory WDN should convey a sufficient amount

of water under adequate pressure throughout its design period. The process of determining how well a WDN can satisfy this goal is the theme of reliability analysis (Gupta and Bhave, 1994).

Much effort has been devoted to the development of a vast array of methods for reliability analysis of WDNs. However, despite having numerous reliability evaluation methodologies, the historical records highlight a high prevalence of the performance degradations and the operational dysfunctions of these networks. It appears to be an accepted fact that high interdependency between elements as well as the dynamic nature of such systems, make these networks more complex and more vulnerable. The lack of capability to completely capture the underlying structure of WDNs has questioned the effectiveness of the classical reliability theories (Eusgeld *et al.*, 2011). In fact, the existing approaches to reliability analysis of infrastructure networks mainly focus on one aspect of the reliability problem and do not provide a complete representation of all factors involved in reliability analysis (Trucco *et al.*, 2012). This, in turn, necessitates the development of a comprehensive reliability assessment model by which to manage such challenges.

The theme of this thesis is to provide a comprehensive picture of the reliability characteristics of WDNs. This research attempts to broaden the scope of reliability analysis by generating new knowledge in this area through using a combination of scientific approaches. This includes reliability engineering, system engineering, graph theory, and water engineering.

## **1.2. Research Gaps**

In the existing literature, researchers have developed two rather different approaches for reliability analysis of WDNs: (1) hydraulic-based approach; (2) topological-based approach.



The hydraulic-based approach is concerned with various hydraulic attributes of WDNs such as flow, demand, pressure head, and water quality. Broadly speaking, this approach addresses the supply of the required amount of water under adequate pressure with appropriate quality (Gupta *et al.*, 2014). The focus of the outcomes of this approach is on the evaluation of the performance of a WDN when exposed to undesired factors such as demand variation, undersized pipes, insufficient pressure, or a combination of these factors (Zhuang *et al.*, 2013).

The topological-based approach evaluates the functionality of a network based on the network's specific architecture (Scardoni *et al.*, 2014). In this approach, either a network's likely behaviour given the reliability of its components is under scrutiny or component importance, as well as the consequences of its failure, are investigated (Boesch *et al.*, 2009). Accordingly, in this approach, reliability is assessed by using a graph invariant from graph theory or by performing centrality analysis.

As the next chapter attests, most existing literature studies the reliability of WDNs from a hydraulic point of view. Despite the importance of studying the topological attributes of WDNs, there is a paucity of research on this subject. The topological reliability analysis has not established its role in the WDNs literature. Most of the existing works capture very generic topological features of WDNs and ignore the valuable characteristics of these networks that can be inferred through their topological properties.

Furthermore, research on reliability analysis of WDNs has typically followed either of the approaches described above. On one hand, the stand-alone use of the topological approach does not account for flow and pressure distribution in WDNs. On the other hand, an exclusive focus on hydraulic analysis yields insufficient information in relation to critical locations as

well as various levels of interdependency among the network components. In order to provide a comprehensive picture of the network reliability, different approach that integrates topological and hydraulic attributes seems a more effective method for reliability analysis of WDNs. This integrated approach is missing in the existing literature.

Additionally, while WDNs are fundamentally complex dynamic systems, the conventional reliability analysis methods are only effective for demonstrating a snapshot of these networks at a given point in time. These methods ignore the variation in the parameters involved in the reliability analysis. Thus, the availability of methods that enable researchers to evaluate the reliability in response to changes in its variables, is still a major challenge.

### **1.3. Research questions**

As the foregoing, this thesis is meant to establish a reliability analysis model for WDNs. Adopting the proposed model, the following questions will be addressed:

**Question 1:** What is the current state of the science of applying reliability theory and system engineering in the field of WDNs?

**Question 2:** How can the exact topological reliability of a network be calculated based on the functioning states of its components?

**Question 3:** How can various performance indicators of WDNs be used as the surrogate measures for assessing the topological reliability?

**Question 4:** Which component has the greatest impact on the network reliability based on its location in the network?

**Question 5:** Which component requires the greatest attention on maintenance based on the joint consideration of its reliability and the consequence of its failure?

**Question 6:** How can the hydraulic-based reliability analysis methods be coupled with the topological-based methods?

**Question 7:** To what extent does change in the initial state of the network affect the reliability at some point in time?

#### **1.4. Research aims**

The overarching aim of this research is to develop a comprehensive reliability assessment model for WDNs that integrates a broad spectrum of various approaches in order to cast a wider net for reliability analysis. The specific aims of this project fall into five distinctive groups.

**Aim 1:** To generate domain-specific metrics for quantifying the topological reliability of WDNs by employing different tools from the reliability engineering domain as well as the network theory.

**Aim 2:** To combine the probabilistic and the importance based reliability analysis approaches, thereby providing a more realistic assessment of reliability.

**Aim 3:** To shift away from a pure topological perspective or an exclusive hydraulic viewpoint towards a combined topological and hydraulic analysis in order to present a more accurate reliability assessment of WDNs.

**Aim 4:** To design a dynamic model for reliability analysis of WDNs by creating a link between the robustness and its affecting factors in order to evaluate the change in the robustness of WDNs in response to changes in the affecting factors over time.

### **1.5. Research significance and innovation**

This research provides two types of implications: *theory development* and *practical implications*.

#### *1.5.1. Theory development*

The doctoral study on which this research is based offers new insight into the reliability analysis of WDNs. In fact, this thesis makes four main theoretical contributions to the literature:

- 1) By tracing the historical development in the reliability analysis of WDNs, it provides a source of information for researchers that facilitates future research for reliability assessment of WDNs.
- 2) By situating this research in the graph theory context, this research compensates the absence of topological characteristics of WDNs in the existing reliability analysis methods.
- 3) This research obtains the more accurate measure of reliability by integrating the topological and the hydraulic attributes of WDNs into a single framework.
- 4) This work is the first known application of system dynamics modelling approach to analyze a quantitative performance indicator of WDNs.

*1.5.2. Practical implications*

WDNs are the backbone of our society that provide the critical service of transmission and distribution of water to meet consumers' demand. However, with the ageing of these networks, numerous problems are emerging such as pipe bursts, leakage, water quality degradation, water supply interruption, and loss of hydraulic performance. In Australia, every year billions of dollars are spent on maintenance of WDNs and replacement of damaged pipeline assets. A significant percentage of these failures and their associated costs can be avoided by implementing an effective predictive maintenance strategy. While the high level of economic benefits resulting from sound maintenance strategies for WDNs is universally recognised, the availability of a cost-effective maintenance program that enables water utilities to protect pipeline assets is still a major challenge.

On one hand, in the research literature, the maintenance frameworks mainly rely on the available historical data on past failures. This may result in replacing pipelines that are still in serviceable conditions. On the other hand, in practice, due to a lack of an effective reliability assessment model, current maintenance and replacement programs are mainly based on the corrective maintenance strategy where the maintenance activities are carried out after occurrence of failures. The results are long-period disruptions and a significant waste of money that can be avoided by implementing an effective predictive maintenance strategy. The predictive maintenance strategy based on the comprehensive reliability assessment model proposed in this research will provide an expert facilitator that helps water service providers to establish and implement a cost-effective maintenance strategy, which relies on identifying and prioritising the vulnerabilities, thereby reducing expenditures on the maintenance activities.

## **1.6. Thesis outline**

This thesis is divided into nine chapters covering the following topics.

First, this general introductory chapter specifies the focus of the thesis. It presents the aim and rationale for this study and identifies research gaps and questions. This chapter also describes the theoretical contributions as well as some practical applications of this research.

By recounting the history and providing a coherent sequence of accomplishments in reliability analysis of WDNs, Chapter 2 presents a panoramic view of how various reliability analysis methods have evolved over time. This chapter also provides a comprehensive review and categorisation of performance indicators of WDNs (Paper 1). Additionally, a literature review of scholarly papers on the development of system dynamics modelling approach in the water sector is presented in this chapter (Paper 2).

Chapter 3 details the research methods used for this thesis. Sequentially, this chapter discusses the different components of this thesis, which have been utilised in pursuing the aims of this research.

Two methods for topological reliability analysis of WDNs are introduced in Chapter 4. The first method (Paper 3) attempts to compute the exact reliability of infrastructure networks by means of a graph theory tool known as spanning tree technique. The second method (Paper 4) quantifies the structural redundancy of WDNs as an indirect measure of reliability. This method first measures the local redundancy of water pipes by recourse to network theory. It then extends the local redundancy analysis further by developing a redundancy index from Shanon entropy.

Chapter 5 (Paper 5) aims at filling the gap surrounding the topological vulnerability analysis of WDNs by creating a link between the global vulnerability of a network and the local importance of its elements. In doing so, this chapter adopts the information entropy to evaluate the vulnerability of a WDN from the character of its heterogeneity.

Chapter 6 (Paper 6) demonstrates how combining probabilistic and importance-based reliability analysis methods can be achieved. In this respect, this chapter introduces a fuzzy inference system model that deals with the problem of vulnerability analysis by mapping reliability and centrality to vulnerability.

Chapter 7 concentrates on coupling the topological and the hydraulic attributes of WDNs. This chapter includes two parts. The first part (Paper 7) proposes a joint entropy model by combining two entropy metrics: *degree distribution entropy-based metric* denoting a topological property of a node and *demand fraction entropy-based metric* representing a hydraulic attribute of a node in a network. The second part (Paper 8) develops a domain specific centrality metric that evaluates the reliability of each component in a WDN with respect to its topological location along with its required demand at any given point in time.

Chapter 8 (Paper 9) involves presenting a system dynamics model for robustness analysis of WDNs. This chapter provides a link between the robustness and its constituent variables aimed at evaluating the evolution of robustness in response to changes in its variables over time.

Finally, the thesis is concluded in Chapter 9. Research outcomes, research contributions and possible avenues for future work are discussed in this chapter.

## *Chapter 2*

### Literature Review



## 2. Literature Review

### 2.1. Overview

A vast array of methods and tools for analysis of WDNs have been developed hitherto. These multidisciplinary methods have been looked at from different angles and are now growing exponentially. In order to follow this growing number of methods, it is necessary to review and document in one place the historical developments in the reliability analysis of WDNs. In this context, this chapter traces the historical trends towards assessing the reliability of WDNs.

This chapter begins with an account of the hydraulic approach for reliability analysis of WDNs and discusses how this approach has evolved over the years, and is continuing to do so. This chapter then examines the conceptions of the topological reliability of WDNs that have been advocated during the past three decades. Moreover, it sets forth the underlying principles of the hydraulic and topological approaches and contextualizes (1) what exactly these approaches are, (2) what motivated the developments of different methods, (3) what are the strengths and the weaknesses of these methods. The literature in this chapter covers three distinct parts as follows:

- Hydraulic reliability analysis and topological reliability analysis
- Performance indicators of WDNs
- Application of System Dynamics modelling to WDNs

#### 2.1.1. *Hydraulic reliability analysis*

The hydraulic approach for analysis of WDNs can trace its origin to the turn of the twentieth century. The pioneering works of Spiess (1887) and Freeman (1892) provided graphical solutions for hydraulic analysis of very basic branched and looped water networks (Mala-Jetmarova, 2015). A few decades later, Howland (1934) and Aldrich (1938) expanded

Freeman's graphical method for more complex WDNs. These graphical methods were aimed at deriving economic pipe diameters by following the principle of economic velocity (Mala-Jetmarova, 2018). However, these methods were useful for analysis of the networks with few pipelines and simple grids. In other words, the applications of the graphical methods in complicated grid systems with several sources and demand nodes presented a challenge. There were a number of responses to this challenge.

In 1936, Hardy Cross, an American structural engineer, published his seminal paper, *Analysis of Flow in Networks of Conduits or Conductors*. This paper developed a mathematical trial and error method in which the flow in pipelines, as an unknown parameter, could be solved by iterative procedures. In 1934, the idea of using electrical networks to solve water pipeline network flow problems appeared in a work by Camp and Hazen. Malcom S. Mcilroy further developed this idea in the article, *Direct-Reading Electric Analyzer for Pipeline Networks*, published in 1950. In this method, linear resistors represent the pipelines in a network and all types of equations are linearized by merging a part of the nonlinear term into the pipe resistance constant. The work of Shamir and Howard (1968) is among the earliest advanced analytical methods that used the Newton-Raphson algorithm to solve the non-linear system equations through iterative procedures. The abovementioned methods account for the chosen unknown hydraulic parameters such as the water demand and the diameter of branches, and the pressure head at each junction node (Spiliotis and Tsakiris, 2010). These methods follow either a forward or an inverse procedure. In the former, a hydraulic determinant of the system (i.e., water demand, and the pressure at each node) is determined for a specified pipeline, whereas in the latter, selected pipelines are treated as variables and are determined to meet a given hydraulic detrainment (Sarbu, 2014).

As early as the 1980s, the use of reliability theory in WDNs began to become recognised in the research literature. In this time period, the critics of the traditional network analysis methods argued that a different approach that takes into account the probability of component failure, as well as the effect of component failure on network performance, seems a more effective method (Goulter, 1987). The main contention was that the traditional methods such as Hardy Cross, Macilory Analyzer, Newton-Raphson, and linear theory methods don't consider the nodal flows under deficient conditions, as such the partially failed WDNs cannot be realistically analyzed (Gupta and Bhave, 1994). Therefore, the design of WDNs was directed to issues related to reliability concern. As a result, the hydraulic reliability analysis of these networks has been the focus of increasing international research over the past three decades. A work by Bao and Mays (1990) is among the first reliability-based paper that adopted the Monte Carlo simulation method to develop a methodology to quantify the reliability of WDNs associated with the hydraulic failure. Gupta and Bhave (1996) conducted a node-flow analysis in order to perform the availability analysis of water at different nodes during deficient conditions. Park (2004) used a multi-objective optimisation method to minimise the network cost and maximise a network reliability measure. The reliability measure proposed in this work accounts for both the nodal surplus power and uniformity of pipe diameters connected to each demand node. Agrawal *et al.* (2007) evaluated the reliability of a WDN by assessing the functionality of the network under the partial failure of its elements. Gupta *et al.* (2014) performed a node flow analysis to estimate the reliability of WDNs under different pipe failure scenarios by joint consideration of pressure head and required flow. Gheisi and Naser (2014) determined the reliability of a WDN under the simultaneous hydraulic failure of multi pipes. Singh and Oh (2015) developed a redundancy metric based on the importance of a link relative to both the local flow and the total flow in a network to assess

the reliability of WDNs. Jensen and Jerez (2018) employed a Subset simulation modelling approach to assess the hydraulic reliability of WDNs in the presence of uncertainty.

Early in this century, researches began to look at the various performance indicators of WDNs as indirect measures of reliability. Accordingly, the past eighteen years have witnessed the development of a great many surrogate measures for the reliability evaluation of WDNs. These measures attempt to assess various key performance indicators of WDNs such as resilience, redundancy, robustness and vulnerability. These performance indicators will be discussed in the following section.

In recent years, the analysis of an explicit level of resilience as an indicator of the ability of WDNs to cope with changing conditions has become a premier approach to evaluate the reliability of WDNs (Atkinson *et al.*, 2014). Todini (2000) addressed the question of WDNs reliability by measuring the degree of resilience for different pipe diameter configurations in the network. Prasad and Wright *et al.* (2015) evaluated the resilience of WDNs to failure as a surrogate measure of reliability by assessing the hydraulic redundancy in the case of disruptive events. Dziedzic and Karney (2016) defined the resilience of WDNs as the average energy efficiency over various operational conditions including emergency events and normal condition. Diao *et al.* (2016) evaluated the resilience in WDNs in response to extreme conditions such as excess demand, pipe failure and substance intrusion. Cimellaro *et al.* (2016) developed a resilience index based on three hydraulic attributes of WDNs including a number of disservices, water supplying capacity of the network, and water quality. Tanyimboh *et al.* (2016) investigated the effectiveness of four surrogate measures for the hydraulic reliability and redundancy of WDNs, namely, resilience index, network resilience, statistical flow entropy and surplus power factor. Liu *et al.* (2017) proposed a resilience index based on the hydraulic gradient of water pipes as an indirect measurement for reliability evaluation of WDNs. Ulusoy *et al.* (2018) assessed

the resilience of a WDN by measuring the consequences of a set of failure scenarios on the performance of the network by developing a hydraulically informed graph theoretic measure of pipe criticality.

A few studies have studied the robustness of WDNs along with the network reliability. For example, Greco *et al.* (2012) developed a demand-driven approach for measuring the robustness of WDNs. Jung *et al.*, (2014) proposed a robustness index by measuring the variation of the system hydraulic performances. Agudelo-Vera *et al.*, (2014) examined the robustness of WDNs based on two main hydraulic parameters: minimal pressure and water quality presented as water age.

The use of the vulnerability concept as the opposite of reliability has been discussed in many works. Yazdani and Jeffrey (2012b) proposed a demand-adjusted entropic measure to quantify the vulnerability of WDNs. Shuang *et al.* (2014) measured the pressure in nodes as well as the flows in pipes during the cascading process with the aim of evaluating the nodal vulnerability of WDNs under cascading failure. Fragiadakis and Christodoulou (2014) and Fragiadakis *et al.* (2016) performed a seismic hydraulic vulnerability assessment of urban water networks using survival analysis. Laucelli and Giustolisi (2015) evaluated the vulnerability of WDNs under seismic actions using a hydraulic modelling paradigm by considering unsupplied demand to customers. Shuang *et al.* (2017) identified the vulnerable pipes in water distribution networks by evaluation of system reliability and failure propagation time by focusing on the balance of water supply and demand. Maiolo *et al.* (2018) evaluated the vulnerability by measuring the significance of the demand deficit during pipe failures in WDNs.

### 2.1.2. Topological reliability analysis

Since the 1980s, there has been a growing realisation that an exclusive hydraulic analysis of WDNs partially describes the behaviour of these networks. This reflection has led to the development of a set of topological reliability analysis methods.

Among the earliest works of the topological analysis of WDNs is the report prepared by Mays and Cullinane (1986) in which the applicability of three methods for evaluating the topological reliability was discussed. The methods under scrutiny were fault tree analysis, state enumeration, cut set and path enumeration methods. Shortly after, Wagner *et al.* (1988) incorporated the concepts of reachability and connectivity into the design of WDNs. Ormsbee and Kessler (1990) attempted to incorporate reliability considerations into the optimal design of WDNs by addressing the explicit level of the topological redundancy.

Starting from the early 1990s, the use of graph theory tools in reliability analysis of WDNs began to become recognised. The pioneering graph theory-based work by Kessler *et al.* (1990) treated a WDN as an undirected graph and defined the connectivity of the network as the minimum number of pipes whose removal from the networks disconnects some nodes from the others. This work then measured the reliability of a network as the extent to which all the nodes in the network remain connected by adopting the edge and the node connectivity metrics. Yazdani *et al.* (2011) and Yazdani and Jeffrey (2012a) studied the relationship between the layout and the functional reliability of WDNs by deploying graph theory quantities known as clustering coefficient, Meshedness coefficient, structural gap, and algebraic connectivity. Perelman and Ostfeld (2011) suggested a graph theory connectivity-based algorithm for identifying weakly and strongly connected clusters in WDNs in order to assess the vulnerability of these networks. Sheng *et al.* (2013) adopted a complex network-based model for exploring the malfunction of a WDN by measuring the spectral properties and subsequently identifying the isolated communities in the network.

Candelieri *et al.* (2015) proposed a graph clustering approach to identify the degree to which a WDN is resilient. Herrera *et al.* (2016) developed a graph theoretic framework for assessing the resilience of WDNs based on quantifying the redundancy of the networks. A network theory measure known as betweenness centrality was adopted in the work of Agathokleous *et al.* (2017) to develop a vulnerability assessment model for WDNs. Di Nardo *et al.* (2017) used graph theory quantities to identify the redundancy properties of WDNs with the goal of evaluating the reliability and robustness of the networks. Giudicianni *et al.* (2018) compared and contrasted the use of different graph theory metrics to quantify the general topological characteristics of WDNs. Robustness of WDNs was evaluated in the work of Di Nardo *et al.* (2018) by using a set of graph spectral techniques to measure the strength of network connectivity. Pagono *et al.* (2018) suggested a graph theory-based multi-dimensional framework consists of a set of attributes such as robustness and redundancy for resilience analysis of WDNs. Meng *et al.* (2018) examined the effect of different topological attributes of WDNs on resilience performance.

**2.2. Paper 1: The four Rs performance indicators of water distribution networks: A review of research literature**

## Statement of Authorship

Title of Paper	The four Rs performance indicators of water distribution networks: A review of research literature
Publication Status	<input checked="" type="checkbox"/> Published <input type="checkbox"/> Accepted for Publication <input type="checkbox"/> Submitted for Publication <input type="checkbox"/> Unpublished and Unsubmitted work written in manuscript style
Publication Details	Gunawan, I., Schultmann, F., & Zarghami S.A. (2017). The four Rs performance indicators of water distribution networks: A review of research literature. <i>International Journal of Quality and Reliability Management</i> . 34(5):720-732.

### Principal Author

Name of Principal Author (Candidate)	Seyed Ashkan Zarghami		
Contribution to the Paper	Conception and design of the work- Reviewing the literature- Classification of the literature Drafting the article- Discussion on findings- Identifying avenues for future work- Writing the manuscript		
Overall percentage (%)	85%		
Certification:	This paper reports on original research I conducted during the period of my Higher Degree by Research candidature and is not subject to any obligations or contractual agreements with a third party that would constrain its inclusion in this thesis. I am the primary author of this paper.		
Signature	<table border="1" style="float: right;"> <tr> <td>Date</td> <td>19/04/2018</td> </tr> </table>	Date	19/04/2018
Date	19/04/2018		

### Co-Author Contributions

By signing the Statement of Authorship, each author certifies that:

- i. the candidate's stated contribution to the publication is accurate (as detailed above);
- ii. permission is granted for the candidate to include the publication in the thesis; and
- iii. the sum of all co-author contributions is equal to 100% less the candidate's stated contribution.

Name of Co-Author	Associate Professor Indra Gunawan		
Contribution to the Paper	Supervising development of the work- Assisting in the literature classification- Evaluation of the manuscript- Helping to edit the manuscript-Final approval of the version to be published		
Signature	<table border="1" style="float: right;"> <tr> <td>Date</td> <td>19/4/2018</td> </tr> </table>	Date	19/4/2018
Date	19/4/2018		

Name of Co-Author	Professor Frank Schultmann		
Contribution to the Paper	Supervising development of the work –Helping to edit the manuscript- Final approval of the version to be published		
Signature	<table border="1" style="float: right;"> <tr> <td>Date</td> <td>07/06/2018</td> </tr> </table>	Date	07/06/2018
Date	07/06/2018		

Please cut and paste additional co-author panels here as required.



# RELIABILITY PAPER

## The four Rs performance indicators of water distribution networks

### A review of research literature

Indra Gunawan, Frank Schultmann and Seyed Ashkan Zarghami  
*Entrepreneurship, Commercialisation and Innovation Centre (ECIC),  
University of Adelaide, Adelaide, Australia*

#### Abstract

**Purpose** – The purpose of this paper is to review the different interpretations of four key performance indicators of water distribution networks (WDNs): reliability, resilience, redundancy and robustness. It then addresses a range of metrics which have been developed to assess the performance of critical infrastructures, in particular WDNs.

**Design/methodology/approach** – The paper provides a comprehensive review and categorization of performance indicators of WDNs. The main focus is on papers addressing performance indicators of water distribution systems, additionally papers on application of complex system approach to critical infrastructures are also included.

**Findings** – Due to this complexity, a wide range of interpretation of WDNs performance indicators exists in the literature. This represents a significant impediment toward universally accepted interpretation of these indicators. Accurate assessment of WDNs' performance depends on clear definition of system performance indicators as well as accurate quantifying of these indicators. The application of 18 metrics as a basis for assessing the system performance have been reviewed in this paper and none are particularly significant as standalone values. Combination of these indicators are required to accurately indicate the performance of WDNs.

**Originality/value** – The authors believe that this paper can be a valuable source of information for academic researchers and practitioners and suggests a roadmap for future works.

**Keywords** Reliability, Resilience, Redundancy, Robustness, Water distribution networks

**Paper type** Literature review

#### 1. Introduction

Water distribution networks (WDNs) consist of multiple interconnected components that collect, treat, store and distribute water between sources and users. High interdependency and nonlinear interactions makes such system fragile, so that a small perturbation propagates in numerous ways and causes the cumulative impact on system failure (Venkatasubramanian, 2010). Viewed from this perspective WDNs serve as a good example of complex systems. Disruption and dysfunction of WDNs would have debilitating effects on safety, economic security, public health and social well-being.

Hence, WDNs can be categorized into critical infrastructures, which are among the most significant technical systems, containing facilities in the form of either asset supply or service provisioning (Bagheri and Ghorbani, 2007). A WDN's functions are designed to convey sufficient water of appropriate quality under adequate pressure. Evaluating the performance of WDNs is crucial to ensuring continuous supply of water to meet consumers' demand under normal and emergency conditions. Thus, protection of WDNs has recently become a large and growing research field with interdisciplinary perspective. For this reason to fully understand the performance of WDNs several indicators should be measured from different perspectives.

On these premises, in this paper we provide a comprehensive review and categorization of performance indicators of WDNs. The main focus is on papers addressing performance



indicators of water distribution systems, additionally papers on application of complex system approach to critical infrastructures are also included.

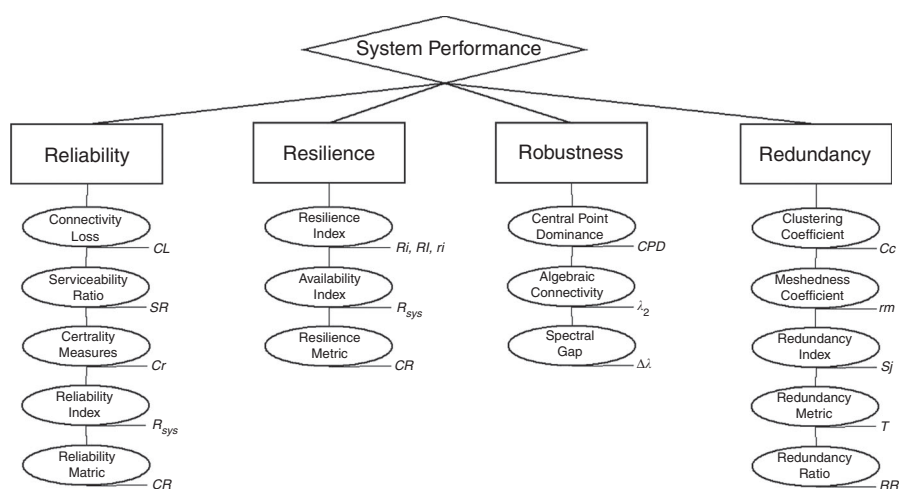
The paper is organized as follows: Section 2 outlines the definition and application of performance indicators through reviewing literature. Section 3 presents the metrics which can be used to quantify WDNs' performance. Finally, Section 4 describes limitation and discusses a possible avenues for future work. Figure 1 outlines the performance indicators and the relevant metrics which have been reviewed in this paper.

## 2. WDN performance indicators

The performance indicators of WDNs have been widely studied in the literature with the goal of assessing the system performance. Though the concept of each indicator is nebulous due to various number of different interpretations over the years, these all demonstrate useful indications of the system performance. This section presents some popular definitions of the key indicators. The list of papers which have been reviewed in this respect are listed in Table I.

### 2.1 Reliability

Reliability is a probabilistic measure of components in a critical infrastructure, which refers to the probability that a given element remains functional at any given time (Murray and Grubestic, 2007). Hashimoto *et al.* (1982) described three different definitions of reliability which are: the probability that a system is in a satisfactory state, the probability that no failure occurs within a fixed period of time, reliability is one minus risk. Bao and Mays (1990) presented two rather different approaches to reliability of WDNs associated with two types of failures, namely, mechanical failure and hydraulic failure. The former represents system failure due to its components failure (e.g. pipe, pump and control valves), whereas the latter denotes system failure due to delivered flow at one or more demand points (e.g. inadequate pressure). Similarly, Ostfeld *et al.* (2001) classified the reliability of WDNs in two main categories: Topological reliability which is the probability of the connectivity of a given network, given its components mechanical reliabilities and hydraulic reliability which refers to provision of water to customers of network within specified limits for a specified time interval. Wagner *et al.* (1988) argued the probabilistic nature of reliability, since it involves stochastic rather than deterministic events, thus reliability



**Figure 1.**  
Outline of the  
performance  
indicators and metrics,  
reviewed in this paper

**Table I.**  
Network's  
performance  
indicators and  
overview papers

Author(s)	Indicator
Awumah <i>et al.</i> (1991)	Redundancy
Bao and Mays (1990)	Reliability
Bruneau <i>et al.</i> (2002)	Resilience
Carlson and Doyle (2002)	Robustness
Dziedzic and Karney (2016)	Resilience
Ferrario <i>et al.</i> (2015)	Robustness
Goulter (1987)	Redundancy
Haimes (2009)	Resilience
Hashimoto <i>et al.</i> (1982)	Reliability
Holling (1996)	Resilience
Hyslop (2007)	Resilience
Jen (2003)	Robustness
Kalungi and Tanyimbih (2003)	Redundancy
Li <i>et al.</i> (2007)	Robustness
Manyena (2006)	Resilience
Murray and Grubestic (2007)	Reliability
Ostfeld <i>et al.</i> (2001)	Reliability
Singh and Oh (2014)	Redundancy
Wagner <i>et al.</i> (1988)	Reliability
Zio (2015)	Resilience

assessment accounts for the likelihood and effects of the system contingency. Murray and Grubestic (2007) compared and contrasted reliability vs vulnerability. They pointed out that reliability refers to possibility of maintaining the performance of component, while vulnerability is the potential of occurring failure in these component which may result in the system failure. In this context, reliability is not viewed as the antonym of vulnerability, hence a vulnerable system is not necessarily the unreliable one.

## 2.2 Resilience

The term resilience has been derived from the Latin word "*resilio*" which means "to leap back" and denotes the ability of system to recover from disruptive events after failure has occurred (Zio, 2015). Hyslop (2007) described some common definitions of resilience in material science, psychology, ecology and business. He presented the general definition of resilience as the ability of bouncing back to an original form Haimes (2009) defined the resilience as "the ability of system to withstand a major disruption within acceptable degradation parameters and to recover within an acceptable time and composite costs and risks." According to Bruneau *et al.* (2002) resilience is related to system behavior to a shock, so that a resilient system reduces failure probability, mitigates the consequence of the shock and reduces the recovery time. Holling (1996) presents the two faces of resilience, which he terms engineering and ecological resilience within complex systems. The first definition accounts for stability and resistance to disturbance and addresses the speed of return to the initial condition, while the second perspective, so-called ecological resilience, concentrates on instability which drives the system to another stability domain. The work of Manyena (2006) traces distinction between vulnerability and resilience. If vulnerability is referred to the degree of capacity, then the two concepts will have an inverse relationship and vulnerability be the flip side of resilience and there is inverse correlation between the two concepts. In the case that vulnerability is viewed as a threat, the degree of potential for loss, the two concepts should be considered as discrete entities. Dziedzic and Karney (2016) contrasted the resilience a stability. In their work resilience is concerned with the persistence of the system, while stability is related to the ability of bouncing back to an equilibrium state after temporary disruption.

### 2.3 Robustness

Robustness of a WDN is concerned with its ability to avoid malfunction and ability to tolerate errors under emergency conditions (Li *et al.*, 2007). In Jen (2003) work, robustness is a measure of feature persistence in a given system where specified perturbations are applied. The paper further develops the definition of robustness to the ability of system to withstand perturbations in structure without change in function. A robust system functions well to fulfill its desired characteristics, despite fluctuations in the behavior of components (Carlson and Doyle, 2002). Similarly, Ferrario *et al.* (2015) defined the robustness as the capability of system to supply the required level of service, when a fraction of its components fail. Yang *et al.* (2015) studied the structure of complex networks and interpreted the relationship of community structure (modularity) and robustness. The paper concluded that the networks with small modularity are more robust than those of with strong community structure, since they have few edges to connect different communities.

### 2.4 Redundancy

In the work of Goulter (1987) and Singh and Oh (2014), redundancy is defined as the existence of an alternative independent path between source and demand nodes through which the water can be conveyed while the main path is failed. Likewise, Kalungi and Tanyimbih (2003) described the redundancy as the aspect of overall WDNs performance under partial system failures, which addresses the system resilience. According to Awumah *et al.* (1991), the redundancy is highly related to the network's layout. The study found direct correlation between redundancy and reliability, so that a redundant WDN is reliable. Singh and Oh (2014) emphasized that having some amount of redundancy in a WDN, ensures its reliability, since in a redundant WDN sufficient residual capacity enables the system to meet water flow requirements.

## 3. Quantifying the performance

This section presents a collection of metrics which have been introduced in the papers to evaluate the performance of the WDNs drawing on the indicators described in Section 2. Table II summarizes the mathematical expression of these metrics and indicates which property is being assessed through each metrics.

### 3.1 Structural metrics

The structural or topological approach to quantify the functionality of a system draws on the system's specific architecture (Scardoni *et al.*, 2014). WDNs performance can be quantified by adopting this approach through proposing the structural indices which are based on the networks layout. This category contains a series of paper from authors who have adopted the concept of graph theory. In their papers WDNs have been mapped into graphs with  $n$  nodes connected by  $m$  links. The publications on this topic are quite new in comparison with the functional indices. The following structural metrics, drawing on network theory, have recently been adopted by researchers to assess the WDNs performance.

**3.1.1 Structural reliability metrics.** 3.1.1.1 Connectivity loss (CL). The concept of CL was presented in the work of Reka *et al.* (2003), as a metric to calculate the average decrease in the ability of sinks to receive the flow from sources. Poljansek *et al.* (2012) introduced the modified version of CL to assess seismic reliability of interdependent critical infrastructure system. Similarly, Fragiadakis and Christodoulou (2014) utilized this metric, as per the following equation for seismic reliability assessment of urban water networks:

$$CL = 1 - \left( \frac{N_{s,j}^{dam.}}{N_{s,j}^{orig.}} \right) \quad (1)$$

**Table II.**  
Metrics for  
quantifying the  
performance  
indicators

Metric	Mathematical expression	Quantifying	Author(s)
Central point dominance	$CPD = \sum_{i=1}^n (b_{max} - b_i)/(n-1)$	Robustness	Yazdani and Jeffrey (2010), Grisi-Filho <i>et al.</i> (2013)
Clustering coefficient	$C_c = 2t_i/k_i(k_i-1)$	Redundancy	Onnela <i>et al.</i> (2005)
Meshedness coefficient	$r_m = \frac{m-n+1}{2n-5}$	Redundancy	Buhl <i>et al.</i> (2006), Yazdani and Jeffrey (2010)
Algebraic connectivity	$\lambda_2$	Robustness	Mohar (1991), Yazdani <i>et al.</i> (2011), Sheng <i>et al.</i> (2013)
Spectral gap	$\Delta\lambda$	Robustness	Estrada (2006), Yazdani <i>et al.</i> (2011)
Connectivity loss	$CL = 1 - (N_{s,j}^{dam.}/N_{s,j}^{orig.})$	Reliability	Poljansek <i>et al.</i> (2012), Fragiadakis and Christodoulou (2014)
Serviceability ratio	$SR = \sum_j^N \omega_j X_j / \sum_j^N \omega_j$	Reliability	Adachi and Ellingswood (2006), Fragiadakis and Christodoulou (2014)
Centrality measures	$C^{r,D} = \sum_i a_{ij} \sum_j p_{ij} / (N-1)^2$ $C^{r,C} = N-1 / \sum r d_{ij}$ $C^{r,B} = \frac{1}{(N-1)(N-2)} \sum \frac{n_{ik}(i)}{n_{jk}}$ $C^{r,J} = \Delta RE(i)/RE$	Reliability	Cadini <i>et al.</i> (2009), Alipour <i>et al.</i> (2012)
Resilience index	$R_i = \int_0^{T_{LC}} (F(t)/T_{LC}) dt$	Resilience	Cimellaro <i>et al.</i> (2015)
Resilience index	$RI = \frac{\int_{t_1}^{t_2} Q(t) dt}{(t_2-t_1)}$	Resilience	Reed <i>et al.</i> (2009)
Availability index	$R_{sys} = \frac{\sum_{t=1}^{t_{period}} \sum_{i=1}^{N_{Count}} Q_{i,t,avl}}{\sum_{t=1}^{t_{period}} \sum_{i=1}^{N_{Count}} Q_{i,t,req}}$	Resilience	Zhuang <i>et al.</i> (2013)
Resilience index	$r_i = \sum_{i=1}^n v_i \sum_{j=1}^n \sqrt{hlink(i,j)} P_k(i,j)$	Resilience	Lam and Tai (2012)
Resilience metric	$C_R = \frac{\sum_{t=1}^T W_t}{T}$	Resilience	Hashimoto <i>et al.</i> (1982), Fowler <i>et al.</i> (2003), Asefa <i>et al.</i> (2013)
Reliability index	$R_{sys} = \sum_{j=1}^N Q_j^{avl} / \sum_{j=1}^N Q_j^{req}$	Reliability	Shuang <i>et al.</i> (2013)
Reliability metric	$C_R = \frac{\sum_{t=1}^T Z_t}{T}$	Reliability	Hashimoto <i>et al.</i> (1982), Fowler <i>et al.</i> (2003), Asefa <i>et al.</i> (2013)
Redundancy index	$S_j = - \sum_{i=1}^{n(j)} (q_{ij}/Q_j) \ln(q_{ij}/Q_j)$	Redundancy	Awumah <i>et al.</i> (1991)
Network Redundancy metric	$T = \frac{R-r(0)p(0)}{1-p(0)}$	Redundancy	Kalungi and Tanyimbih (2003)
Redundancy ratio	$R_R = \frac{1}{( S -1)^2} \sum I(v,j)$	Redundancy	Duenas-Osorio <i>et al.</i> (2007)

where  $N_{s,j}^{orig.}$  and  $N_{s,j}^{dam.}$  denote the number of sources connected to  $j$ th sink in the original network and damaged network, respectively.

3.1.1.2 Serviceability ratio (SR). The serviceability of a WDN is related to the number of nodes which remain accessible for at least one source node after the perturbation occurs (Adachi and Ellingswood, 2006). The SR have been used in the work of Adachi and Ellingswood (2006) and Fragiadakis and Christodoulou (2014) to assess the reliability of civil infrastructure systems after occurring the earthquake. It can be formulated as follows:

$$SR = \frac{\sum_j^N \omega_j X_j}{\sum_j^N \omega_j} \tag{2}$$

where  $\omega_j$  is weighting factor of facility  $j$ ,  $X_j$  a binary parameter with 0 or 1 value depending on the accessibility of node  $j$  and  $N$  represents the number of nodes.

$SR$  ranges between 0 and 1.  $SR = 0$  indicates entire loss of serviceability, whereas  $SR = 1$  implies unimpaired function.

3.1.1.3 Reliability centrality measures. Alipour *et al.* (2012) computed the reliability of power transition networks by employing four reliability centrality measures, proposed by Cadini *et al.* (2009): reliability degree centrality –  $C^{r,D}$ , reliability closeness centrality –  $C^{r,C}$ , reliability betweenness centrality –  $C^{r,B}$  and reliability information centrality –  $C^{r,I}$ . The following equations express the mathematical formula for the aforementioned metrics:

$$C^{r,D} = \frac{\sum_i a_{ij} \sum_j p_{ij}}{(N-1)^2} \quad (3)$$

$$C^{r,C} = \frac{N-1}{\sum rd_{ij}} \quad (4)$$

$$C^{r,B} = \frac{1}{(N-1)(N-2)} \sum \frac{n_{jk}(i)}{n_{jk}} \quad (5)$$

$$C^{r,I} = \frac{\Delta RE(i)}{RE} \quad (6)$$

where  $a_{ij}$  represents the elements of the adjacency matrix,  $p_{ij}$  the elements of the most reliable path matrix,  $rd_{ij}$  the elements of the shortest path matrix,  $n_{jk}(i)$  the number of topological shortest path between nodes  $j$  and  $k$  including node  $i$  and  $RE = 1/N(N-1)\sum 1/rd_{ij}$  represents the network reliability efficiency.

3.1.2 Structural redundancy metrics. 3.1.2.1 Clustering coefficient. The clustering coefficient ( $C_c$ ) is a metric based on the graph theory which captures the density of triangles in a network (Cuarda *et al.*, 2015). Onnela *et al.* (2005) presented the basic quantification of  $C_c$  as follows:

$$C_c = \frac{2t_i}{k_i(k_i-1)} \quad (7)$$

where  $k_i$  denotes the degree of node  $i$  and  $t_i$  is the number of triangles attached to the node  $i$ .

3.1.2.2 Meshedness coefficient. Yazdani and Jeffrey (2010) proposed the meshedness coefficient ( $r_m$ ) to measure the density of rectangular loops in WDNs.  $r_m$  is defined as the ratio of actual number of loops and possible number of loops as in:

$$r_m = \frac{m-n+1}{2n-5} \quad (8)$$

where  $r_m$  ranges from 0 to 1.  $r_m = 0$  denotes tree structures, while  $r_m = 1$  represents complete grid-like structures (Buhl *et al.*, 2006).

3.1.3 Structural robustness metrics. 3.1.3.1 Central point dominance. The central point dominance (CPD) indicates that to what extent nodes in a networks are dependent to a specific node. CPD varies from 0 to 1 and networks with higher values of CPD rely on fewer nodes to maintain their function, whereas networks with lower values of CPD are more decentralized, hence more resilient to targeted attacks to hubs (Grisi-Filho *et al.*, 2013). Yazdani and Jeffrey (2010) used the CPD to reveal the most central nodes in a network which is formulated as:

$$CPD = \frac{\sum_{i=1}^n (b_{max} - b_i)}{(n-1)} \quad (9)$$

where  $n$  is the number of nodes,  $b_{max}$  and  $b_i$  are, respectively, the largest betweenness centrality value and the relative betweenness centrality of node  $i$ .

3.1.3.2 Algebraic connectivity. Algebraic connectivity ( $\lambda_2$ ) is the second smallest Laplacian eigenvalue of a graph. Studied the application of  $\lambda_2$  in the graph theory and can be viewed as a measure of connectivity (Mohar, 1991). Yazdani *et al.* (2011) employed the algebraic connectivity to quantify the structural robustness of WDNs. A WDN with the higher values of  $\lambda_2$  demonstrates higher robustness against stresses. Sheng *et al.* (2013) conducted spectral analysis based on Laplacian matrix to compute the algebraic connectivity to detect and identify the isolated communities in WDNs.

3.1.3.3 Spectral gap. Estrada (2006) referred to the spectral gap as a metric for indirect exploration of a network. The paper mentioned that if the gap between the first and second eigenvalues of the adjacency matrix ( $\Delta\lambda$ ) is sufficiently high, the network will be a good expander. Furthermore, Yazdani *et al.* (2011) used the spectral gap as a metric to measure the robustness of WDNs. They pointed out that a networks with higher value of structural gap showcase a good expansion properties and small values of structural gap can be an evidence of existence of bridges and articulation points in the network.

### 3.2 Functional (hydraulic) metrics

Functional metrics are related to various hydraulic attributes of WDNs such as; flow, demand, nodal pressure, water quality, etc. This subsection reviews some functional metrics associated with hydraulic attributes of WDNs.

3.2.1 Functional reliability metrics. Zhuang *et al.* (2013) proposed an availability metric to quantify the WDNs resilience. They expressed the system availability as the fraction between total available demand and total required demand as per the following equation:

$$R_{sys} = \frac{\sum_{t=1}^{period} \sum_{i=1}^{NCount} Q_{i,t,avl}}{\sum_{t=1}^{period} \sum_{i=1}^{NCount} Q_{i,t,req}} \quad (10)$$

where  $R_{sys}$  denotes system availability;  $Q_{i,t,avl}$  flow delivered to  $i$ th node at time  $t$ ;  $Q_{i,t,req}$  required demand of  $i$ th node at time  $t$ ;  $Period$  = time duration under system failure;  $NCount$  = total number of demand nodes. Similarly, Shuang *et al.* (2013) presented a simple equation to assess the reliability of WDNs. They expressed the reliability of system as:

$$R_{sys} = \frac{\sum_{j=1}^N Q_j^{avl}}{\sum_{j=1}^N Q_j^{req}} \quad (11)$$

where  $R_{sys}$  denotes the reliability of WDN;  $N$  the number of nodes;  $Q_j^{avl}$  the available flow at  $j$ th node under failure condition;  $Q_j^{req}$  the require demand when  $j$ th node is under normal condition.

Fowler *et al.* (2003) and Asefa *et al.* (2013) measured the reliability of water resource systems ( $C_R$ ) using the following metric proposed by Hashimoto *et al.* (1982):

$$C_R = \frac{\sum_{t=1}^T Z_t}{T} \quad (12)$$

where  $Z_t$  is a binary state variable, which is either 0 for an unsatisfactory state or 1 for a satisfactory state.

3.2.2 Functional resilience metrics. Cimellaro *et al.* (2015) proposed a resilience index to measure the WDNs performance. The proposed index ( $R$ ) is composed of three indices.

The first one ( $R_1$ ) addresses the social dimensions of resilience which is based on the demand.  $R_1$  is defined as:

$$R_1 = \int_0^{T_{LC}} (F_1(t)/T_{LC})dt \quad (13)$$

where  $F_1(t)$  denotes performance function proportional to the number of equivalent households without service,  $T_{LC}$  is control time.

The second one is the function of storage tank level and quantifies the technical aspect of a WDN and is formulated as:

$$R_2 = \int_0^{T_{LC}} (F_2(t)/T_{LC})dt \quad (14)$$

where  $F_2(t)$  the water level in the storage is tank and  $T_{LC}$  is control time. The third one is based on the water quality and is defined as:

$$R_3 = \int_0^{T_{LC}} (F_3(t)/T_{LC})dt \quad (15)$$

where  $F_3(t) = Q(t)/Q^*$ ;  $Q^*$  and  $Q(t)$  are water quality indices before and after perturbation, respectively. In order to measure the overall resilient performance of WDNs, the three indices are multiplied, hence:

$$R = R_1.R_2.R_3 \quad (16)$$

Reed *et al.* (2009) assessed the resilience of networked infrastructure  $R$  by employing the fragility and quality metrics. They defined the fragility as the percentage of number of disservices relative to the total number of customers and the quality as the integration of the area under the quality function curve,  $Q(t)$ . In the equation form  $R$  is:

$$RI = \frac{\int_{t_1}^{t_2} Q(t)dt}{(t_2-t_1)} \quad (17)$$

In Equation (8),  $Q(t) = Q_\infty - (Q_\infty - Q_0)e^{-bt}$  where  $Q_\infty$  is the capacity of the fully functioning system,  $Q_0$  represents post-event capacity,  $b$  is an empirical parameter which is used to quantify the rapidity of the recovery process and  $t$  denotes time in days post-event. They also suggested the ratio of  $(Q_\infty - Q_0)$  to  $Q_\infty$  as a measure of system robustness.

Lam and Tai (2012) evaluated the resilience of a node in terms of reliability and the weighted factor. In their paper, it is represented as:

$$r_i = \sum_{i=1}^n v_i \sum_{\forall \text{link}(i,j)} P_k(i,j) \quad (18)$$

where  $P_k(i, j)$  is the reliability of an independent connection path connecting a pair nodes  $i$  and  $j$  and  $v_i$  the self-exhausted weight.



3.2.3 *Functional redundancy metrics.* Awumah *et al.* (1991) proposed a redundancy metric based upon the entropy concept.

$$S_j = - \sum_{i=1}^{n(j)} \left( \frac{q_{ij}}{Q_j} \right) \ln \left( \frac{q_{ij}}{Q_j} \right) \quad (19)$$

728

where  $Q_j = \sum_{i=1}^{n(j)} q_{ij}$  is the total flow to node  $j$  provided by the link between nodes  $i$  and  $j$ ;  $n(j)$  denotes number of links incident on node  $j$ ;  $q_{ij}/Q_j$  the relative flow capacity of links incident on the node  $j$ .

Equation (9) quantifies the redundancy of each node. The redundancy of the network is summation of redundancies of each individual nodes.

Kalungi and Tanyimbih (2003) suggested Equation (20) to calculate the network redundancy  $T$ , based on reliability and factors such as; interaction between supply path, multiplicity of the paths and the degree of contribution of each path to the supply of a node.

$$T = \frac{R-r(0)p(0)}{1-p(0)} \quad (20)$$

where  $R$  is the system reliability, which is a function of total demand for the network as well as the probability of full or partial availability of components in the system.

Singh and Oh (2014) used two approaches to quantify the network redundancy using Tsallis entropy concept. The first approach assesses the relative importance of a link to its node, while the second one evaluates the relative importance of a link to the total flow. The paper then modified the redundancy of network by incorporating the edge factor for the pipe material and path parameter.

The redundancy ratio ( $R_R$ ) of a node accounts for the existence of node-independent paths from a node to each of the nodes of the set of neighbors of its neighbors, as Duenas-Osorio *et al.* (2007) put forward. The equation form of  $R_R$  is as follows:

$$R_R = \frac{1}{([S]-1)^2} \sum I(v,j) \quad (21)$$

where  $([S]-1)^2$ , is a normalization factor and  $I(v,j)$  denotes the number of node-independent paths between each pair of distinct nodes.

In a similar way to measure the reliability of water resource systems, Fowler *et al.* (2003) and Asefa *et al.* (2013) quantified the resilience of water resource systems ( $C_{RS}$ ) by adopting the following metric proposed by Hashimoto *et al.* (1982):

$$C_{RS} = \frac{\sum_{t=1}^T W_t}{T} \quad (22)$$

where  $W_t$  is a binary parameter with a value of 0 and 1, which indicates a transition from an unsatisfactory to a satisfactory state.

#### 4. Conclusions and research directions

##### 4.1 Limitation of review

For this review, we focused on the scholarly papers in peer-reviewed journals' databases and attempted to include all relevant journal articles which have been published between 1982 and 2016, this inclusion, however, cannot be exhaustive. Some papers may not be listed

in the databases or database available to us. We also excluded master's theses, doctoral dissertation, majority of textbooks and some papers where authors developed or superseded the earlier works.

#### 4.2 Findings

The performance of WDNs depends on complex interaction among large number of subsystems and components as well as external conditions. Due to this complexity, a wide range of interpretation of WDNs performance indicators exist in the literature. This represents a significant impediment toward universally accepted interpretation of these indicators. The assessment of WDNs' performance is a daunting task and the accurate assessment of WDNs' performance depends on clear definition of system performance indicators as well as accurate quantifying of these indicators. The application of 18 metrics as a basis for assessing the system performance have been reviewed in this paper and none are particularly significant as standalone values. Combination of these indicators are required to accurately indicate the performance of WDNs.

#### 4.3 Future research directions

The evaluation of WDNs' performance has received significant attention in the literature. Significant research has been devoted to quantifying the performance indicators in the context of WDNs. A collection of quantitative performance indicators have been developed over the last four decades, yet existing approaches to assess the performance of WDNs refer to either structural organization based on the network theory or hydraulic behavior of WDNs. It is conceivable for future research to establish a set of dual metrics to evaluate the structural and hydraulic performance of WDNs concurrently. Moreover, to the authors' knowledge, no systematic study of WDNs' performance by adopting the system dynamic approaches has been reported, hence possible future work will be devoted to assess the WDNs' performance by employing system dynamics approaches.

#### References

- Adachi, T. and Ellingswood, B.R. (2006), "Serviceability of earthquake-damaged water systems: effect of electrical power availability and power backup systems on system vulnerability", *Reliability Engineering and System Safety*, Vol. 93 No. 1, pp. 78-88.
- Alipour, Z., Saniee Monfared, M.A. and Zio, E. (2012), "Comparing topological and reliability-based vulnerability analysis of Iran power transmission network", *Journal of Risk and Reliability*, Vol. 228 No. 2, pp. 139-151.
- Asefa, T., Clayton, J., Adam, A. and Anderson, D. (2013), "Performance evaluation of water resources system under varying climate condition", *Journal of Hydrology*, Vol. 508, pp. 53-65.
- Awumah, K., Goulter, I. and Bhatt, S.K. (1991), "Entropy-based redundancy measures in water-distribution networks", *Journal of Hydraulic Engineering*, Vol. 117 No. 5, pp. 595-614.
- Bagheri, E. and Ghorbani, A. (2007), "The state of the art in critical infrastructure protection: a framework for convergence", *International Journal of Critical Infrastructures*, Vol. 14 No. 3, pp. 215-244.
- Bao, Y. and Mays, L.W. (1990), "Model for water distribution system reliability", *Journal of Hydraulic Engineering*, Vol. 116 No. 9, pp. 1119-1137.
- Bruneau, M., Chang, S.E., Eguchi, R.T., Lee, G.C., O'Rourke, T.D., Reinhorn, A.M., Shinozuka, M., Tierney, K., Wallace, W.A. and Von Winterfeldt, D. (2002), "A framework to quantitatively assess and enhance the seismic resilience of communities", *Earthquake Spectra*, Vol. 19 No. 4, pp. 733-752.

- Buhl, J., Gautrais, J., Reeves, N., Sole, R.V., Valverde, S., Kuntz, P. and Theraulaz, G. (2006), "Topological patterns in street networks of self-organized urban settlements", *The European Physical Journal B- Condensed Matter and Complex System*, Vol. 49 No. 4, pp. 513-522.
- Cadini, F., Zio, E. and Petrescu, C.A. (2009), "Optimal expansion of an existing electrical power transmission network by multi-objective genetic algorithms", *Reliability Engineering and System Safety*, Vol. 95 No. 3, pp. 173-181.
- Carlson, J.M. and Doyle, J. (2002), "Complexity and robustness", *Proceeding of The National Academy of Sciences of The United States of America*, Vol. 99, February 2006, pp. 2538-2545.
- Cimellaro, G.P., Tinebra, A., Renschler, C. and Fragiadakis, M. (2015), "New resilience index for urban water distribution networks", *Journal of Structural Engineering 2016*, Vol. 142 No. 8, pp. 1-13.
- Cuarda, L., Salcedo-Sanz, S., Delsler, J., Fernandez, S.T. and Geem, Z.W. (2015), "A critical review of robustness in power grids using complex networks concept", *Energies*, Vol. 8 No. 9, pp. 9211-9265.
- Duenas-Osorio, L., Craig, J.I., Goodno, B.J. and Bostrom, A. (2007), "Interdependent response of networked systems", *Journal of Infrastructure Systems*, Vol. 13 No. 3, pp. 185-194.
- Dziedzic, R. and Karney, B.W. (2016), "Performance index of water distribution networks under multiple loading conditions", *Journal of Water Resource Planning and Management*, Vol. 142 No. 1, pp. 1-11.
- Estrada, E. (2006), "Network robustness to targeted attacks. The interplay of expansibility and degree distribution", *The European Physical Journal B – Condensed Matter and Complex Systems*, Vol. 52 No. 4, pp. 563-574.
- Ferrario, E., Pedroni, N. and Zio, E. (2015), "Evaluation of the robustness of the critical infrastructures by Hierarchical Graph representation, clustering and Monte Carlo simulation", *Reliability Engineering and System Safety*, Vol. 155, pp. 78-96.
- Fowler, H.J., Kilsby, C.G. and O'Connell, P.E. (2003), "Modelling the impacts of climate change and variability on the reliability, resilience and vulnerability of a water resource system", *Water Resource Research*, Vol. 39 No. 8, pp. 1-11.
- Frageadakis, M. and Christodoulou, S.E. (2014), "Seismic reliability of urban water networks", *Earthquake Engineering & Structural Dynamics*, Vol. 43 No. 3, pp. 357-374.
- Grisi-Filho, J.H.H., Ossada, R., Ferriera, F. and Amako, M. (2013), "Scale-free networks with the same degree distribution: different structural properties", *Physics Research International*, Vol. 2013, pp. 1-9.
- Goulter, I.C. (1987), "Current and future use of systems analysis in water distribution network design", *Civil Engineering Systems*, Vol. 4 No. 4, pp. 175-184.
- Haimes, Y.Y. (2009), "On the definition of resilience in systems", *Risk Analysis*, Vol. 29 No. 4, pp. 498-501.
- Hashimoto, T., Stedinger, J.R. and Loucks, D.P. (1982), "Reliability, resiliency and vulnerability criteria for water resource system performance evaluation", *Water Resource Research*, Vol. 18 No. 1, pp. 14-20.
- Holling, C.S. (1996), "Engineering within ecological constraints", in Schulze, P. (Ed.), *Engineering Resilience Versus Ecological Resilience*, Vol. 2, National Academy Press, Washington, DC, pp. 31-44.
- Hyslop, M. (2007), *Critical Information Infrastructures: Resilience and Protection*, Spring Science Business Media, New York, NY.
- Jen, E. (2003), "Stable or robust? What is difference?", *Complexity*, Vol. 8 No. 3, pp. 12-18.
- Kalungi, P. and Tanyimboh, T.T. (2003), "Redundancy model for water distribution systems", *Reliability Engineering and System Safety*, Vol. 82 No. 3, pp. 275-286.

- Lam, C.Y. and Tai, K. (2012), "Evaluating the reliability of infrastructure networks by resilience analysis", *IEEE International Conference on Industrial Engineering and Engineering Management 2012*, pp. 1165-1169.
- Li, P., Wang, B.H., Sun, H., Gao, P. and Zhou, P. (2007), "A limited resource model of fault tolerant capability against cascading failure of complex network", *The European Physical Journal B*, Vol. 62 No. 1, pp. 101-104.
- Manyena, S.B. (2006), "The concept of resilience revisited", *Disasters*, Vol. 30 No. 4, pp. 434-450.
- Mohar, B. (1991), "Graph theory, combinatorics and applications", in Alavi, Y., Ghartrand, G., Oellermann, O.R. and Schwenk, A.J. (Eds), *The Laplacian Spectrum of Graphs of Mathematics*, Vol. 2, Wiley, New York, NY, pp. 871-898.
- Murray, A.T. and Grubestic, T.H. (2007), "Critical infrastructure: reliability and vulnerability", in Murray, A.T. and Grubestic, T.H. (Eds), *Overview of Reliability and Vulnerability in Critical Infrastructure*, Springer-Verlag, Heidelberg and Berlin, pp. 1-8.
- Onnela, J.P., Saramaki, J., Kertesz, J. and Kaski, K. (2005), "Intensity and coherent of motifs in weighted complex networks", *E, Statistical Nonlinear and Soft Matter Physics*, Vol. 71 No. 6, pp. 1-4.
- Ostfeld, A., Kogan, D. and Shamir, U. (2001), "Reliability simulation of water distribution systems- single and multi-quality", *Urban Water*, Vol. 4 No. 1, pp. 53-61.
- Poljansek, K., Bono, F. and Gutierrez, E. (2012), "Seismic risk assessment of interdependent critical infrastructure systems: the case of European gas and electricity networks", *Earthquake Engineering and Structural Dynamics*, Vol. 41 No. 1, pp. 61-79.
- Reed, D.A., Kapur, K.C. and Christie, R.D. (2009), "Methodology for assessing the resilience of networked infrastructure", *IEEE System Journal*, Vol. 3 No. 2, pp. 174-180.
- Reka, A., Albert, I. and Nakarado, G.L. (2003), "Structural vulnerability of the North American power grid", *Physical Review. E, Statistical Nonlinear and Soft Matter Physics*, Vol. 69 No. 2, pp. 1-4.
- Scardoni, G., Motrelor, A., Tosadori, G. and Laudanna, C. (2014), "Node interference and robustness: performing virtual knock-out experiments on biological networks: the case of leukocyte integrin activation network", *PLoS ONE*, Vol. 9 No. 2, pp. 1-10.
- Sheng, N., Jia, Y., Xo, Z., Ho, S.L. and Kan, C.W. (2013), "A complex network based model for detecting isolated communities in water distribution networks", *Chaos* 23, Vol. 23 No. 4, pp. 1-10.
- Shuang, Q., Zhang, M. and Yuan, Y. (2013), "Performance and reliability analysis of water distribution systems under cascading failures and the identification of crucial pipes", *PLoS One*, Vol. 9 No. 2, pp. 1-11.
- Singh, V.P. and Oh, J. (2014), "A Tsallis entropy-based redundancy measure for water distribution networks", *Physica A: Statistical Mechanics and its Application*, Vol. 421, pp. 360-376.
- Venkatasubramanian, V. (2010), "Systemic risks management in complex process plants: challenges, opportunities, and emerging trends", *Conference on Control and Fault-Tolerant Systems*, pp. 1-10.
- Wagner, J.M., Shamir, U. and Marks, D.H. (1988), "Water distribution reliability: analytical methods", *Journal of Water Resources Planning and Management*, Vol. 114 No. 3, pp. 253-275.
- Yang, Y., Li, Z., Chen, Y., Zhang, X. and Wang, S. (2015), "Improving the robustness of complex networks with preserving community structure", *PLoS*, Vol. 10 No. 2, pp. 1-14.
- Yazdani, A. and Jeffrey, P. (2010), "Complex network analysis of water distribution systems", *An Interdisciplinary Journal of Nonlinear Science*, Vol. 21 No. 1, pp. 1-10.
- Yazdani, A., Otoo, R.A. and Jeffrey, P. (2011), "Resilience enhancing expansion strategies for water distribution systems", *Environmental Modelling & Software 2011*, Vol. 26 No. 12, pp. 1574-1582.

Zhuang, B., Lansey, K. and Kang, D. (2013), "Resilience/availability analysis of municipal water distribution system incorporating adaptive pump operation", *Journal of Hydraulic Engineering*, Vol. 139 No. 5, pp. 527-538.

Zio, E. (2015), "Challenges in the vulnerability and risk analysis of critical infrastructures", *Reliability Engineering and System Safety*, Vol. 152, pp. 137-150.

**Further reading**

Porse, E. and Lund, J. (2015), "Network structure, complexity and adaptation in water resource system", *Civil Engineering and Environmental System*, Vol. 32 Nos 1-2, pp. 143-156.

**Corresponding author**

Seyed Ashkan Zarghami can be contacted at: [ashkan.zarghami@adelaide.edu.au](mailto:ashkan.zarghami@adelaide.edu.au)

**2.3. Paper 2: System dynamics modelling process in water sectors: A review of research literature**

## Statement of Authorship

Title of Paper	System Dynamics Modelling Process in Water Sector: a Review of Research Literature		
Publication Status	<input checked="" type="checkbox"/> Published	<input type="checkbox"/> Accepted for Publication	
	<input type="checkbox"/> Submitted for Publication	<input type="checkbox"/> Unpublished and Unsubmitted work written in manuscript style	
Publication Details	Zarghami S.A., Gunawan, I., and Schultmann, F. (2018). System Dynamics Modelling Process in Water Sector: a Review of Research Literature. <i>System Research and Behavioral Science</i> . <a href="https://doi.org/10.1002/sres.2518">https://doi.org/10.1002/sres.2518</a>		

### Principal Author

Name of Principal Author (Candidate)	Seyed Ashkan Zarghami		
Contribution to the Paper	Conception and design of the work- Reviewing the literature- Classification of the literature- Identifying the modelling process- Drafting the article- Discussion on findings- Identifying avenues for future work- Writing the manuscript		
Overall percentage (%)	85%		
Certification:	This paper reports on original research I conducted during the period of my Higher Degree by Research candidature and is not subject to any obligations or contractual agreements with a third party that would constrain its inclusion in this thesis. I am the primary author of this paper.		
Signature		Date	8/08/2018

### Co-Author Contributions

By signing the Statement of Authorship, each author certifies that:

- i. the candidate's stated contribution to the publication is accurate (as detailed above);
- ii. permission is granted for the candidate to include the publication in the thesis; and
- iii. the sum of all co-author contributions is equal to 100% less the candidate's stated contribution.

Name of Co-Author	Associate Professor Indra Gunawan		
Contribution to the Paper	Supervising development of the work- Assisting in the literature classification- Evaluation of the manuscript- Helping to edit the manuscript-Final approval of the version to be published		
Signature		Date	8/8/2018

Name of Co-Author	Professor Frank Schultmann		
Contribution to the Paper	Supervising development of the work –Helping to edit the manuscript- Final approval of the version to be published		
Signature		Date	

Please cut and paste additional co-author panels here as required.

## ■ Research Paper

# System Dynamics Modelling Process in Water Sector: a Review of Research Literature

Seyed Ashkan Zarghami\* , Indra Gunawan  and Frank Schultmann

*Entrepreneurship, Commercialisation & Innovation Centre (ECIC), Faculty of Professions, University of Adelaide, Adelaide, SA, Australia*

System dynamics (SD) approach is a framework for reproducing the behaviour of the real systems. This approach has demonstrated a proven capability in modelling the dynamic interactions among the factors affecting the behaviour of complex systems and therefore can be used by researchers and policymakers as a useful decision tool. Recently, many researchers have devoted significant efforts in adopting the SD modelling technique in water sector, where complex interactions and feedback loops govern the behaviour of the system. This paper presents a comprehensive literature review of scholarly papers in the water sector on the development of the SD models followed by discussion on different steps of the modelling process. A discussion of each step is accompanied by the water sector examples, exemplified in the existing literature. The paper also discusses the advantages and disadvantages of using system dynamics in the water sector and provides directions for future research in this field. © 2018 John Wiley & Sons, Ltd.

**Keywords** modelling process; system dynamics; system evaluation and testing; water sector; water supply and distribution networks

## INTRODUCTION

The complexity of systems in which we work and live has increased and is increasing. The information about the structure and relationships in a system stems from our mental model. Unreliability in the perception of the dynamic conse-

quences of a system with five or six variables is the primary shortcoming of a mental model (Doyle & Ford, 1998). Moreover, in the world of the growing complexity, incessant and accelerating changes require a new approach to manage everything that changes through time. The field of system dynamics (SD) was created to address these needs.

In the early 1960s, Jay W. Forrester, a pioneering American computer engineer, system scientists and the founder of the field of SD published his seminal book, *Industrial Dynamics*.

---

\*Correspondence to: Seyed Ashkan Zarghami, Entrepreneurship, Commercialisation & Innovation Centre (ECIC), Faculty of Professions, University of Adelaide, 5/10 Pulteney St., Adelaide, SA 5005, Australia.  
E-mail: ashkan.zarghami@adelaide.edu.au

Forrester outlined his idea and set out the essence of SD in this book. Shortly after its publication, the span of applications grew from the industrial sector to a wide range of areas such as population, health policy, infrastructures, project management and ecological and economic systems.

System dynamics approach aims to capture the dynamic interactions within complex systems from a holistic perspective. The power of the system dynamics approach lies in its ability to model the behaviour of a system which has not been experienced yet (Sterman, 2000). SD visualizes the evolution of the system, which in turn leads to an exhaustive insight into the dynamics of the system (Rodrigues & Bowers, 1996). The three characteristics of an SD model are *information feedback loops, computer simulation and linking with mental models*, as Lane (2000) put forward. Sterman *et al.* (2015) listed the following distinct methodological principles of SD that facilitate the integration of multiple data sources of a different kind through identifying dozens of interactions and significant time delays.

- SD models represent the structure of a system, and because the behaviour of a system arises from its structure, it represents the behaviour of a system as well.
- Disequilibrium is captured by SD models.
- SD focuses on a broad model boundary and is able to consider the feedbacks as well as the delayed impact of decisions beyond the symptom of a problem in space and time.
- Modellers can test the models through grounded methods so that they can capture the interactions among system components, which are consistent with the real world.

Water Supply and Distribution Networks (WSDNs) are the backbone of our society, which provide the critical service of supplying and conveying water to meet consumers' demand (Zarghami *et al.*, 2018). WSDNs are complex in the sense that all of their interconnected elements interact in a complex and dynamic manner (Sheng *et al.*, 2013). In recent years, this field has been the focus of increasing international research. Drought potential, climate change, population growth, government regulations and utility security are among several challenges

facing the water sector. Underlying feedback loops characterize the behaviour of WSDNs. As noted earlier, an SD model is able to explore the impact of feedback loops on the system (Rehan *et al.*, 2013). Furthermore, SD has demonstrated its superiority over other simulation tools in highlighting the feedback and complex interactions between different elements, where causes and effects are indiscernible (Jiang *et al.*, 2015). As a result, many researchers and practitioners in water sector have successfully adopted the SD approach, covering a wide variety of topic areas, which is growing rapidly. Thus, studying the application of the SD modelling approach in WSDNs presents challenges for researchers and practitioners because it can be a very time-consuming task.

On this premise, this paper serves two purposes. First, we provide a comprehensive review on application of the SD approach in WSDNs. This allows researchers to properly recall, identify and investigate different applications of SD in the WSDN domain. Second, motivated by the fact that the process of the modelling is more important than the model itself (Lane, 2017), we outline different steps of the SD modelling process, accompanied by the water sector examples, exemplified in the existing literature. The main focus is on the literature that touches SD modelling process within the water sector. Although we have limited our review to sources, for which WSDNs serve, as the focus of the work, the papers and books that introduce and define the basic concepts of SD theory are also included. The topics covered by this article along with the relevant references are presented in Table 1.

## BUILDING BLOCKS OF SYSTEM DYNAMICS

This section presents the building blocks of SD, which provide a basis for developing SD modelling approach.

### *Stock*

A stock is a key element of any system, which can be measured at any given time. It accumulates the materials and information over time and



Table 1 Distribution of reviewed papers/books by category

Topics	Selected references
General SD theory	Coyle (2000); Doyle and Ford (1998); Duggan (2016); Lane (2000); Lane (2008); Lane (2017); Luna-Reyes and Andersen (2003); Meadows (2009); Morecroft (1997); Pruyt (2006); Pruyt (2013); Randers (1980); Richardson and Paugh (1981); Roberts <i>et al.</i> (1983); Saleh <i>et al.</i> (2010); Simonovic (2002); Sterman (2000); Sterman <i>et al.</i> (2015); Wolstenholme (1990)
Water resources management	Ahmad and Prashar (2010); Beall <i>et al.</i> (2011); Bianchi and Montemaggiore (2008); Elmahdi <i>et al.</i> (2007); Fernandez and Selma (2004); Gao and Liu (1997); Hassanzadeh <i>et al.</i> (2014); Huang and Yin (2017); Kotir <i>et al.</i> (2016); Madani and Marino (2009); Mirchi <i>et al.</i> (2012); Qi and Chang (2011); Qin <i>et al.</i> (2011); Rehan <i>et al.</i> (2011); Rehan <i>et al.</i> (2014); Ryu <i>et al.</i> (2012); Sheng <i>et al.</i> (2013); Simonvic (2001); Simonvic and Rajasekaram (2004); Stave (2003); Sun and Sun (2015); Sun <i>et al.</i> (2002); Susnik <i>et al.</i> (2012); Tidwell <i>et al.</i> (2004); Walters and Javernick-Will (2015); Wang <i>et al.</i> (2011); Wei <i>et al.</i> (2016); Winz <i>et al.</i> (2009); Wu <i>et al.</i> (2013); Xu <i>et al.</i> (2002); Zarghami <i>et al.</i> (2018); Zhang <i>et al.</i> (2008)
Wastewater collection system	Guest <i>et al.</i> (2010); Rehan <i>et al.</i> (2011); Rehan <i>et al.</i> (2014); Wirahadikusumah and Abraham (2003)
Model simulation and validation	Barlas (1996); Burg <i>et al.</i> (2016); Sun and Sun (2015)
Application of SD in other fields	Gunawan <i>et al.</i> (2017); Jiang <i>et al.</i> (2015); Rashedi and Hegazy (2016); Rodrigues and Bowers (1996); Zlatanovic (2012)
Coupling SD with other approaches	Ahmad and Simonovic (2004); Wirahadikusumah and Abraham (2003); Yang <i>et al.</i> (2008); Wang <i>et al.</i> (2017); Li <i>et al.</i> (2018)
Dynamic Master Logic Diagram	Ferrario <i>et al.</i> (2015); Ferrario and Zio (2014); Hu and Modarres (1999)

represents the state of the system (Meadows, 2009). Mathematically, a stock variable can be expressed by the following equation (Pruyt, 2013).

$$x = \int_{t_0}^t (+ax - bx)dt + x_0 \quad (1)$$

where  $ax$  and  $bx$  denote the value of inflow and outflow, respectively, at any given time between the initial time  $t_0$  and the current time  $t$  and  $x_0$  represents the initial value of the stock at time  $t_0$ . In the SD models, stocks are represented by a rectangle.

#### Flow

Stock changes over time through the action of flow. Flow variables regulate the state of stock variables. Flow is labelled as either inflow or outflow. Accumulating differences between all inflows and outflows indicates whether the stock is held in dynamic equilibrium or not

(Meadows, 2009). In the SD models, a flow is represented by a pipe with arrow and valve.

#### Feedback

Meadows (2009) describes the feedback as the way that a system runs itself. The author further portrays a feedback loop as a mechanism that creates a persistent behaviour of a system over a long period of time. Feedback loops are either positive, which reinforce the original change or negative, which oppose the original change, as described by Sterman (2000).

#### Auxiliaries

Auxiliary variables support variables that are constant. They are the function of stocks that simplify the flow equations. Auxiliary variables are normally used for ease of communication and clarity. Adding or removing an auxiliary variable does not change the mathematical structure of the system (Sterman, 2000).

## TOOLS FOR SYSTEM DYNAMICS

Using diagramming tools in an SD model facilitates the communication. The presentation of model assumptions in the form of equation would be inappropriate and counter-productive. While a small minority understands the tools of calculus, the SD diagramming tools present the model assumptions in the form that can be readily understood by most people (Lane, 2008). This section discusses the leading diagramming methods adopted in SD.

### Causal Loop Diagram

A causal loop diagram (CLD) visually depicts the feedback structure of a system through variables connected by arrows whose polarities indicate the causal influence of one variable on another. The polarity is either positive, representing the same direction in the changing/moving in the model or negative, denoting the opposite direction in the changing/moving in the model (Rashedi & Hegazy, 2016). Bianchi and Montemaggiore (2008) compared Balanced Scorecard (BSC) approach and SD model. The authors pointed out that BSC has a static nature, therefore cannot capture the dynamic relationships among the parameters of the four proposed performance measures of a water company: *internal process*, *customers*, *financial* and *growth*. The paper also stressed the importance of the feedback relationships between variables and pointed out the incapability of BSC approach due to following an open-loop logic. To this end, the authors turned the BSC into a CLD in which the cause and effect relationships between the key variables of a water company through a number of reinforcing and balancing loops within the aforementioned perspectives were shown. Walters and Javernick-Will (2015) delineated a CLD to depict the causal structure of the water services in the developing countries. Initially, the authors performed a content analysis of journals published in the water sector to identify the factors that affect the rural water system functionality, and then, the polarity analysis along with the cross impact analysis was carried out to pinpoint the interactions between the

factors. Rehan *et al.* (2011) framed the scope of the municipal water and wastewater network management through a simplified CLD. The proposed CLD incorporates three self-reinforcing loops: *infrastructure deterioration*, *revenue generation* and *operational expenditures* which are countered by three balancing loops: *infrastructure rehabilitation*, *user fees adjustments* and *capital expenditures* (Fig. 1).

### Stocks and Flows Diagram

In a stock and flow diagram (SFD), the stock is illustrated as a container and the flow as a pipe filling and draining this container (Duggan, 2016). SFD reveals system properties that cannot be ascribed to any of the individual components of the system. Linking stock and flow structure with feedback provides a thorough representation of physical processes and delays (Sterman, 2000). Stave (2003) illustrated the overall structure of Las Vegas water system using SFD (Fig. 2) to visualize the places in which water is accumulated (stock variables) and the rate at which water moves from one stock to another (flow variables). Madani and Marino (2009) developed two SFDs for the SD model of Iran's Zayandeh-Rud River Basin. The stock variables in the hydrological subsystem represent *available surface water*, *available groundwater* and *water supply*, whereas in the socio-political and economic subsystem, stock variables are *water supply* and *population*. Rehan *et al.* (2014) constructed three SFDs to develop management strategies for an urban wastewater collection infrastructure system. The research categorized the system into three sectors: wastewater collection sector, finance sector and consumer sector. The model visualized the interrelationships and feedback loops in the wastewater collection network management.

### Dynamic Master Logic Diagram

Dynamic Master Logic Diagram (DMLD) is a logic-based diagram to model the dynamic behaviour of physical systems. DMLD originated from Goal Tree Success Tree (GTST) and Master Logic Diagram (MLD) by substituting time-

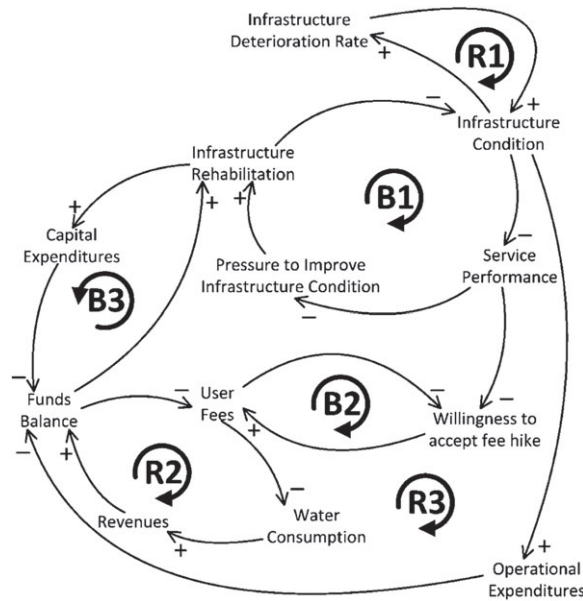


Figure 1 Feedback loops in water and wastewater network management. Proposed by Rehan et al. (2011)

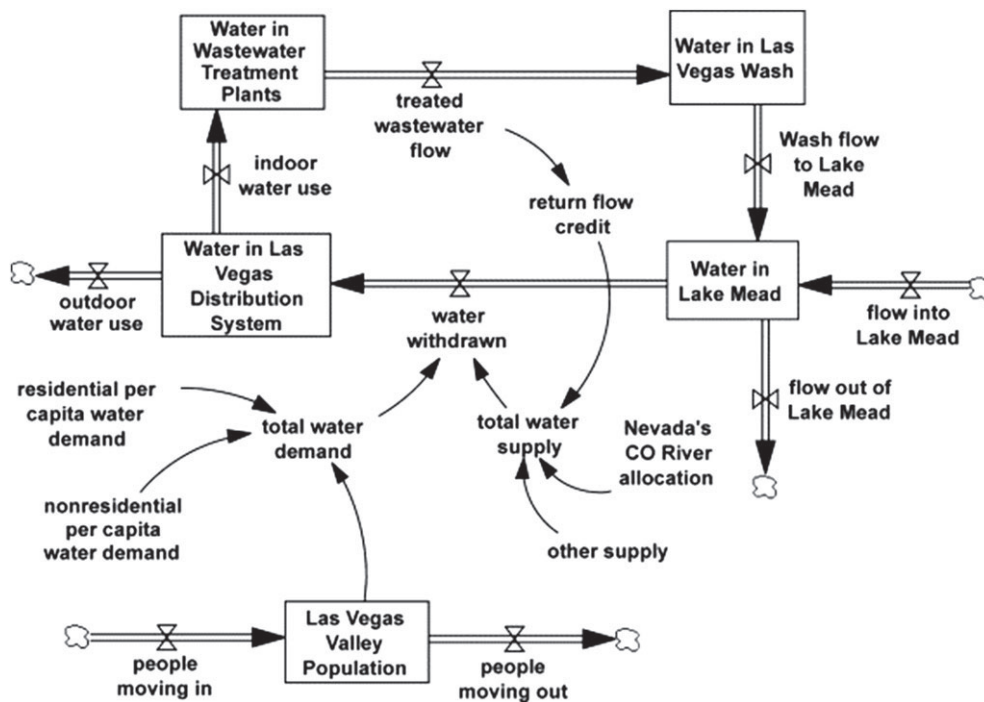


Figure 2 Las Vegas water system stock and flow diagram (Stave, 2003)

dependent fuzzy logic for Boolean logic. This new approach rectifies the static nature of Boolean logic-based approach and represents a full-

scale time-dependent behaviour and an uncertain behaviour of the complex physical systems (Hu & Modarres, 1999). Ferrario et al. (2015)

employed GTST-DMLD for analysing the robustness and recovery properties of critical infrastructures. The proposed diagram comprises of three parts: the Goal Tree (GT) part represents the system goals and functions, the Success Tree (ST) part showcases hierarchy of the objects of the system and the interrelationships are represented in DMLD section. Figure 3 shows the scheme of GTST-DMLD.

The modelling process involves different steps in the literature, ranging from three to seven steps (Table 2). Although the modelling process can be grouped differently, the steps are part of an iterative process in which the modellers will be able to revise the problem and the model boundary as they develop the dynamic hypothesis and causal loops (Morecroft, 1997). This section presents a typical process of constructing a system dynamics modelling in water sector drawing on the classification proposed by Sterman (2000).

STEPS OF THE MODELLING PROCESS

Different authors have identified different SD modelling process using different arrangements. Luna-Reyes and Andersen (2003) tabulated the SD modelling process across the classic literature.

Problem Articulation

Problem articulation shapes the entire modelling. Boundary of study, time horizon, issue of concern

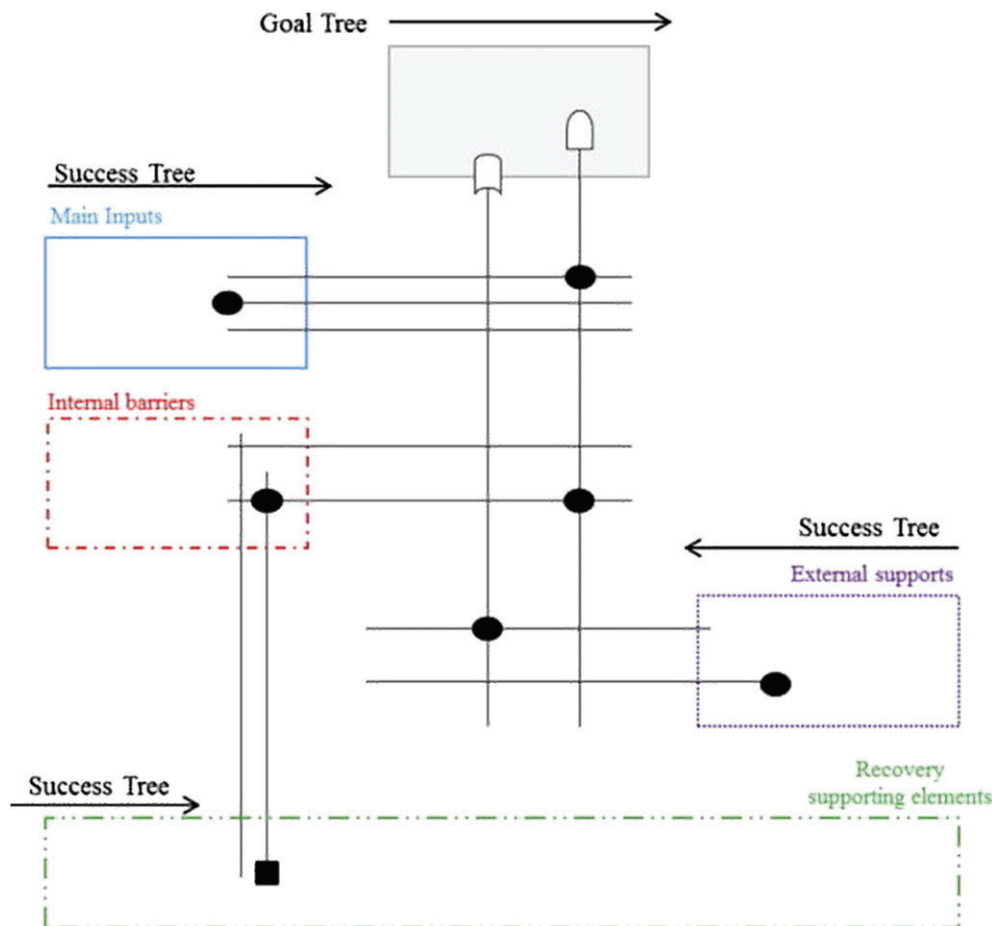


Figure 3 A schematic GTST-DMLD adapted from Ferrario and Zio (2014) [Colour figure can be viewed at wileyonlinelibrary.com]

Table 2 The system dynamics modelling process across the classic literature (Luna-Reyes &amp; Andersen, 2003)

Randers (1980)	Richardson and Paugh (1981)	Roberts <i>et al.</i> (1983)	Wolstenholme (1990)	Sterman (2000)
Conceptualization	Problem definition	Problem definition	Diagram construction and analysis	Problem articulation
Formulation	System conceptualization	System conceptualization	Simulation phase (stage 1)	Dynamic hypothesis
Testing	Model formulation	Model representation		Formulation
	Analysis of model behaviour	Model behaviour		Testing
Implementation	Model evaluation	Model evaluation	Simulation phase (stage 2)	Policy formulation and evaluation
	Policy analysis	Policy analysis and model use		
	Model use			

and level of analysis are identified in this step (Morecroft, 1997). Guest *et al.* (2010) identified a list of items that should be considered for assessment of wastewater management alternatives. The authors employed a force field diagram as a simple and graphical tool to articulate the factors influencing their model. Defining advancing and restraining forces in their force field diagram provided a foundation for more complex and dynamics diagrams such as CLD and SFD. Zhang *et al.* (2008) developed the SD model of the water resources planning of the city of Tianjin, China. In the problem definition phase, they assumed the boundary of the model as the total administrative area of Tianjin city and the time horizon of 2004 to 2015. Four major subsystems, *population subsystem*, *economy subsystem*, *water pollution control subsystem* and *water resources subsystem*, were defined at the early stage of the model development.

### Dynamic Hypothesis

Preliminary sketch of the main interactions and feedback loops represents the dynamic hypothesis. A dynamic hypothesis plays a significant role in complexity reduction. Through a dynamic hypothesis, a modeller constructs a number of structure-behaviour pairs to explain puzzling dynamics (Morecroft, 1997). A preliminary explanation of the structural relationship between elements that alter demand and supply over time in the Las Vegas water system shaped the dynamic

hypothesis in the work of Stave (2003). Gao and Liu (1997) developed an SD model for opting the optimal exploitation scenario for water resources system in Hangzhong Basin, China. The research initiated a dynamic hypothesis by dividing the regional water resources system into subsystems and then splitting each subsystem to different departments. The paper then defined the causal feedback structure of water supply and demand to depict the overall feedback mechanism of the basin. Beall *et al.* (2011) introduced a participatory system dynamics modelling to create a model for sustainable water resource management for Palouse basin in the northwest of USA. The authors developed the dynamic hypothesis by following an iterative process that included workshops and model building between workshops.

### Formulation

In the formulation step, the dynamic hypothesis is transformed into the detail diagram of feedback processes; subsequently, the algebraic equations are established for the model (Morecroft, 1997). In the model formulation phase, Wang *et al.* (2011) determined a set of mathematical equations to estimate water demand, water supply and effect of water price on demand in Yulin city in China. The paper then developed the mathematical model within Vensim software and found that focusing on the demand-sided approach rather than the supply-sided approach is more

efficient to solve the water scarcity problem in the project of interest. Elmahdi *et al.* (2007) developed a system dynamics model to improve the efficiency of water allocation in irrigation water systems. The hierarchical decomposition approach was adopted to formulate water demand and the connection between the model components. The authors then employed 'what if' scenarios to calculate the following parameters: *water use from each resource, final shortage value, water cost and economical return to the region*. Qi and Chang (2011) proposed a system dynamics model to estimate the domestic water demand for Manatee County, Florida. The proposed model consists of three submodels, including socioeconomic, population and water demand. The work quantified the intertwined internal connections among and between elements of these submodels by fitting regression and empirical equations derived from US Census Bureau and US Department of Labor and other relevant literature. Huang and Yin (2017) developed an SD model by proposing a demand balance index along with analysing the regression equation of population growth for predicting the supply and demand balances trend of water resources in Shandong Province, China.

### Model Testing

The validity of results in a system dynamics model is strongly dependent on the validity of the model. Model testing mainly (not necessarily) takes place after the initial model formulation and before the policy analysis step. In the model testing and validation phase, the model is compared with the real world and the decision to accept or reject the model is made in this step (Zlatanovic, 2012). As Mirchi *et al.* (2012) explains, although it is necessary to verify an SD model as a decision support tool for water resources planning and management, model verification and validation is a daunting task owing to insufficient data and in some cases such as socio-political subsystems is challenging due to lack of appropriate methods to quantify subsystems. In what follows, the model validity in the water sector is reviewed.

### Calibration

Model calibration is concerned with adjusting the model variables in such a way that the model outputs can fit the collected data. In this step, the model outputs are fitted into the observed data; hence, the model structure may be corrected (Sun & Sun, 2015). Fernandez and Selma (2004) gathered the historical values of decline in the average piezometric level of the irrigated landscapes in south-east of Spain. The comparison between historical data and simulation values confirmed that the model fitted the historical behaviours. Similarly, Ahmad and Prashar (2010) performed a model calibration through comparison between the historical data and the model simulation for the municipal water demand in South Florida in order to make sure that the model is able to reproduce nearly the same pattern as the real observed data. Tidwell *et al.* (2004) developed a system dynamics model for the regional water planning in north-central New Mexico. For verification purposes, four variables with characteristics of having an integrated information among many other variables in the model were selected and compared with the historical data. In addition to providing a sense of credibility and confidence for the model, the calibration of the model indicated that the data collected from disparate sources were measured in a self-consistent manner. Qin *et al.* (2011) and Wei *et al.* (2016) constructed an SD model for an urban water management model. Model calibration was carried out by using two metrics as per the following mathematical expressions:

$$M = \max\left(\frac{q_{pi} - q_{mi}}{q_{mi}}\right) \quad (2)$$

$$E = \frac{\sqrt{(q_{pi} - q_{mi})^2}}{\frac{\sum q_{pi}}{n}} \quad (3)$$

where  $M$  is maximum relative error and indicates the worst-case model performance,  $E$  is the normalized standard error that characterizes the average case of the model performance and  $q_{pi}$  and

$q_{mi}$  denote the predicted value and the corresponding measured value, respectively. Wu *et al.* (2013) constructed an SD model to assess the vulnerability of water resources in Bayingolin, China. The calibration process was carried out by measuring three statistical parameters: *mean of the relative error*, *coefficient of determination* and *Nash–Sutcliffe efficiency coefficient*. These parameters demonstrated the ability of the system to reproduce the historical behaviour in the preceding years so as to ensure the accuracy of the results.

### Structural Test

The structural test is conducted to determine how well the structure of a model matches the real case. In the case that model components do not have the real-world counterparts, this test relies on the mental model of people familiar with the system (Winz *et al.*, 2009). Hassanzadeh *et al.* (2014) carried out a two-step structural test to assess the qualitative performance of the SD model of the water resources management for Saskatchewan River Basin, Canada. The direct structural testing was performed based on knowledge about the real system. Additionally, the structural-orientated behaviour testing was conducted by testing the system behavioural patterns using various sensitivity analyses.

### Sensitivity Analysis

Sensitivity analysis determines how model responds to change in variables. Sensitivity analysis can also highlight the variables which require special attention in the modelling analysis. Sensitivity analysis is particularly useful for models that cannot be tested against the robust set of empirical data (Burg *et al.*, 2016). Simonovic (2002) applied system dynamics approach to model the global world water resources. The work evaluated the sensitivity of the model with regard to uncertainty to key variables. In the paper, the following sensitivity analysis were conducted: the impact of life expectancy on domestic water supply, the effect of using different

technology on the cost of water supply, the impact of different shape of relationship between agricultural water supply and land yield, sensitivity test for clean water used for dilution of wastewater with different ratios. Sun *et al.* (2002) defined the following equation to examine the sensitivity of SD model of Miyun reservoir in China.

$$S_Q = \frac{\Delta Q(t)/Q(t)}{\Delta X(t)/X(t)} \quad (4)$$

where  $S_Q$  denotes the sensitivity degree of state  $Q$  to parameter  $X$ ,  $Q(t)$  is the system state at time  $t$ ,  $X(t)$  represents the system parameter affecting the system state at time  $t$ ,  $\Delta Q(t)$  is the increment of state  $Q$  and  $\Delta X(t)$  is the increment of parameter  $X$  at time  $t$ . In the sensitivity analysis phase,  $\pm 10\%$  change was applied to each parameter per 4 years for the study time horizon, and subsequently, the sensitivity degree values were calculated using Equation (2), and finally, parameters with high influence on the system were identified. Susnik *et al.* (2012) assumed 33 different scenarios for conducting the sensitivity analysis for the SD model of water scarcity assessment in Kairouan region in Tunisia. During these tests, the authors only changed the value of particular variables, whereas the value of other variables remained the same as the baseline run. The results of the sensitivity test exhibited the weighted impact of parameters on the aquifer behaviour.

### Comparison with Reference Modes

A reference mode is a graphical representation of a particular characteristic of a system behaviour over time and refers either to past or future behaviour (Simonovic, 2002). Stave (2003) illustrated the problem definition graph as a reference graph, incorporating demand and supply parameters for Las Vegas, Nevada water management case. The comparison between the base case output model and the reference graph indicated that the model reproduced a general trend that define the water management problem; therefore, the conclusion pertaining to the

model validation against the anticipated trend was drawn.

### Policy Formulation and Evaluation

The purpose of policy analysis is to investigate how specific change in a parameter in a system dynamics model affects the system's response. Policy analysis enables the system modellers to identify the policy levers that will have the desired impact on the model (Saleh *et al.*, 2010). Xu *et al.* (2002) explored various water supply and demand scenarios in a water resources system dynamics model in order to analyse the sustainability of the water resources in the Yellow River Basin in China. The study addressed 10 different scenarios and policies. Each scenario consisted of multiple interconnected variables and inputs from different socio-economic sectors. The output of policy analysis was identifying the viable options with more contributions to the sustainability of water supply in the Yellow River Basin. Ahmad and Prashar (2010) evaluated different policy options such as *low flow appliances*, *xeriscaping* and *pricing*, in order to reduce the municipal water demands. The article compared the effect of each policy with the status quo scenario over a time horizon of 25 years. The outcome of the study revealed that the combined use of different policies would lead to a maximum possible reduction in the municipal water demands. Simonovic and Rajasekaram (2004) used a system dynamics approach to build an integrated water resource management model for Canada. The authors classified 12 scenarios into four groups: *population*, *water*, *economy* and *energy*. Each scenario contains multiple policy variables from different sectors dealing with a particular issue in one of the previously mentioned category. The conclusions drawn from the policy analysis revealed the strong dependencies between Canada's future development and maintaining an acceptable quality of water resources and controlling demand. Ryu *et al.* (2012) used an SD model to simulate the outcomes of four different policy options stipulated in the aquifer management plan for Snake River Basin, Idaho. The paper created five alternatives from the different combination of

these policies in order to evaluate the system reliability. The value of 97% was set as a target for the system reliability, and a selected alternative was assessed to check whether it would satisfy the target criterion. Kotir *et al.* (2016) developed an SD simulation model for sustainable water resources management in the Volta River Basin, Ghana. In addition to the business as usual scenario, three different scenarios including *development of water infrastructure*, *cropland expansion* and *dry conditions* were proposed in the policy analysis stage. The authors measured the variables such as crop yield, net-farm income, population, agricultural, domestic and industrial, water demand under these scenarios. The outcome of this stage was determining the maximum possible growth in each variable by 2050.

### COUPLING SYSTEM DYNAMICS WITH OTHER APPROACHES

In the recent past, coupling SD approach with other methods in order to enhance its capability to solve complex problems has attracted the attention of many researchers. Ahmad and Simonovic (2004) coupled system dynamics approach with geographic information system (GIS) to model feedback-based dynamic processes in time and space in water resources systems. The authors coined the term 'spatial system dynamics (SSD)' for the new approach. The main characteristic of SSD modelling approach is a two-way dynamic exchange between SD and GIS, which provides a feedback in time and space. The case study of Red River Basin in the north-central USA was selected to investigate the applicability of this approach. The outcome of the research demonstrates that the integrated model is able to enhance the ability of GIS for temporal modelling through capturing the spatially referenced feedback processes in dynamic systems. Wirahadikusumah and Abraham (2003) proposed a decision-making framework for the life cycle cost analysis in sewer management systems adopting dynamic programming in conjunction with a Markov chain model. The research applied this integrated model to the case study of the sewer network in the city of



Indianapolis, USA in order to optimize the limited fund in the sewer maintenance and rehabilitation projects. The combination of SD modelling and impact analysis is presented in the work of Yang *et al.* (2008). The paper initially proposed an SD model to simulate the water shortages in Taiwan. The article then adopted the impact analysis and defined indices to measure the severity of water shortage. The total cost for each proposed scenario was estimated concluding that the proposed integrated method is appropriate for capturing the interactions between water shortage and total cost. Wang *et al.* (2017) established an integrated approach of SD, orthogonal experimental design and inexact optimization model for supporting water resources management under uncertainty. The authors drew the conclusion that the integrated model provides stable intervals for the objective function and decision variables with different credibility level. Li *et al.* (2018) developed a hybrid SD and optimization approach for supporting sustainable water resources planning in Zhengzhou, China, concluding that the hybrid model is a rational try to support water resources management.

## CONCLUSIONS AND RESEARCH DIRECTIONS

In this paper, we have performed a comprehensive review of journal articles dealing with the application of SD modelling approach in water sector. We have also attempted to discuss different steps of SD modelling process by referring to several examples from the literature. This article makes contribution by providing a source of references for researchers and practitioners, which facilitates future research in applying the SD modelling approach to water sector.

### Limitation of Review

For this review, we focused on the scholarly papers in the peer-reviewed journals' databases and attempted to include all relevant journal articles and some books which have been

published between 1980 and 2018; this inclusion, however, cannot be exhaustive. Some papers may not be listed in the databases or database available to us. Furthermore, some papers where authors developed or superseded the earlier works were excluded from our review. We also excluded Master's theses and doctoral dissertation, because they are not peer reviewed in the same fashion as published journal articles and therefore may be less significantly rigorous than those that are peer reviewed and published.

## Findings

This paper attempted to provide an overview of SD modelling process in water sector by reviewing the existing journal papers and books. The review demonstrated several benefits of SD approach for water sector as follows:

- The factors affecting WSDNs are not straightforward. To solve this problem, the SD diagramming tools visualize the feedback loops and the interrelationship between components and therefore provide a better understanding of how these factors interact dynamically, which enables practitioners to comprehend the counter-intuitive of WSDN behaviours.
- In the context of water resources management, the outcome of many SD models critique the traditional supply-side approaches and suggest the new approaches such as demand-side management for developing sustainable and effective water resources management policies.
- The output of SD model can be employed by researchers, government bodies and others concerned with water sector as a decision support tool in the implementation of more effective policies.
- Researchers and practitioners may take advantage of the SD model by conducting what if analysis in order to determine how the change in the constitutive elements of water supply and distribution systems affect the overall performance of the systems over time.

Nevertheless, as Pruyt (2006) put forth, stand-alone use of SD approach has revealed several shortcomings. First, SD yields insufficient information about what views, dimensions and time frames are of most importance. Second, SD does not take into account multiple conflicting views as well as multiple dimensions over time. Third, as stated by Coyle (2000), the uncertainty associated with obtaining qualitative data along with quantification of qualitative variables makes the SD simulation results fragile. Fourth, SD has problem in modelling low-level systems because this paradigm focuses on modelling the high-level structure of a system using aggregate items. Finally, because the flows describing the causal dependencies in the system must be expressed mathematically, the modeller must have a firm grasp of the mathematics underlying these relationships. Sterman (2000) suggested SD modelling approach as a complement to, not replacement for, other existing methods. As such, SD can be adopted as a platform for combining other approaches. This in turn enhances its capabilities in decision-making processes. In doing so, researchers in water sectors have proposed several innovative methods by coupling SD with other approaches such as GIS, impact analysis and Markov chain model, optimization methods, to name a few.

### Future Research Directions

The directions for future research are recommended as follows.

- First, SD approach has been extensively applied in the water sector in recent years. Yet most previous studies have adopted this approach to develop the simulation models for water resources field and did not take into consideration the performance of water distribution networks (WDNs). Performance indicators of WDNs (e.g. reliability, resilience, robustness, redundancy) may vary over time and in response to other internal and external variables of the system such as demand nodes, sources, pipe ageing and rehabilitation actions. Therefore, as suggested by Gunawan *et al.* (2017), further attempts should be made to reproduce the behaviour of the real-world WDNs and to take a system-level view for modelling and analysing the complex interactions and feedback loops that govern the counter-intuitive behaviour of WDNs.
- Second, a large number of complex problems such as planning, maintenance, scarcity and security are associated with WSDNs. As noted in the preceding subsection, stand-alone use of SD might not be appropriate in addressing these problems; thus, it should be complemented with other methodologies (e.g. the conventional reliability analysis methods) to enhance its capabilities. Such integrated approach is missing in current water sector research and can be addressed in future work.

### REFERENCES

- Ahmad S, Prashar D. 2010. Evaluating municipal water conservation policies using a dynamic simulation model. *Water Resources Management* **24**(13): 3371–3395.
- Ahmad S, Simonovic SP. 2004. Spatial system dynamics: new approach for simulation of water resources systems. *Journal of Computing in Civil Engineering* **18**(4): 331–340.
- Barlas Y. 1996. Formal aspects of model validity and validation in system dynamics. *System Dynamics Review* **12**(3): 183–210.
- Beall A, Fiedler F, Boll J, Cosens B. 2011. Sustainable water resource management and participatory system dynamics. Case Study: developing the Palouse Basin participatory model. *Sustainability* **3**: 720–742.
- Bianchi C, Montemaggiore GB. 2008. Enhancing strategy design and planning in public utilities through “dynamic” balanced scorecards: insights from a project in a city water company. *System Dynamics Review* **24**(2): 175–213.
- Burg MB, Peeters H, Lovis WA. 2016. Introduction to uncertainty and sensitivity analysis in archaeological computational modeling. In *Uncertainty and Sensitivity Analysis in Archaeological Computational Modeling*, Burg MB, Peeters H, Lovis WA (eds.). Springer International Publishing: Switzerland; 1–20.
- Coyle G. 2000. Qualitative and quantitative modelling in system dynamics: some research questions. *System Dynamics Review* **16**(3): 225–244.
- Doyle JK, Ford DN. 1998. Mental models concepts for system dynamics research. *System Dynamics Review* **14**(1): 3–29.

- Duggan J. 2016. *System dynamics modeling with R*. Lecture Notes in Social Networks, Springer International Publishing: Switzerland.
- Elmahdi A, Malano H, Etschells T. 2007. Using system dynamics to model water-reallocation. *The Environmentalist* **27**(1): 3–12.
- Fernandez JM, Selma MAE. 2004. The dynamics of water scarcity on irrigated landscapes: Mazarron and Aguilas in south-eastern Spain. *System Dynamics Review* **20**(2): 117–137.
- Ferrario E, Pedroni N, Zio E. 2015. Analysis of the robustness and recovery of critical infrastructures by goal tree–success tree: dynamic Master Logic Diagram, within a multistate system-of-systems framework, in the presence of epistemic uncertainty. *ASME Journal of Risk and Uncertainty Part B* **1**(3).
- Ferrario E, Zio E. 2014. Goal tree success tree-Dynamic Master Logic Diagram and Monte Carlo simulation for the safety and resilience assessment of multistate system of systems. *Engineering Structures* **59**: 411–433.
- Gao Y, Liu C. 1997. Research on simulation of optimal decision making for a regional water resources system. *International Journal of Water Resources Development* **13**(1): 123–134.
- Guest JS, Skerlos SJ, Daigger GT, Corbett JRE, Love NG. 2010. The use of qualitative system dynamics to identify sustainability characteristics of decentralized wastewater management alternatives. *Water Science and Technology* **61**(6): 1637–1644.
- Gunawan I, Schultmann F, Zarghami SA. 2017. The four Rs performance indicators of water distribution networks: a review of research literature. *International Journal of Quality & Reliability Management*. **34**(5): 720–732.
- Hassanzadeh E, Elshorbagy A, Wheeler H, Gober P. 2014. Managing water in complex systems: an integrated water resources model for Saskatchewan, Canada. *Environmental Modelling and Software* **58**: 12–26.
- Hu YS, Modarres M. 1999. Evaluating system behavior through Dynamic Master Logic Diagram (DMLD) modeling. *Reliability Engineering and System Safety* **64**(2): 241–269.
- Huang L, Yin L. 2017. Supply and demand analysis of water resources based on system dynamics model. *Journal of Engineering and Technological Sciences* **49**(6): 705–720.
- Jiang Z, Dongping F, Zhang M. 2015. Understanding the causation of construction workers' unsafe behaviors based on system dynamics modelling. *Journal of Management in Engineering* **31**(6): 4014099(14).
- Kotir JH, Smith K, Brown G, Marshall N, Johnstone R. 2016. A system dynamics simulation model for sustainable water resources management and agricultural development in Volta River Basin, Ghana. *Science of the Total Environment* **573**: 444–457.
- Lane DC. 2000. Should system dynamics be described as a 'hard' or 'deterministic' systems approach? *Systems Research and Behavioral Science* **17**(1): 3–22.
- Lane DC. 2008. The emergence and use of diagramming in system dynamics: a critical account. *Systems Research and Behavioral Science* **25**(1): 3–23.
- Lane DC. 2017. Behavioural system dynamics: a very tentative and slightly skeptical map of the territory. *Systems Research and Behavioral Science* **34**(4): 414–423.
- Li Z, Li C, Wang X, Peng C, Cai Y, Huang W. 2018. A hybrid system dynamics and optimization approach for supporting sustainable water resources planning in Zhengzhou City, China. *Journal of Hydrology* **556**(2018): 50–60.
- Luna-Reyes LF, Andersen DL. 2003. Collecting and analyzing qualitative data for system dynamics: methods and models. *System Dynamics Review* **19**(4): 271–296.
- Madani K, Marino MA. 2009. System dynamics analysis for managing Iran's Zayandeh-Rud River Basin. *Water Resources Management* **23**(11): 2163–2187.
- Meadows DH. 2009. *Thinking in systems: a primer*. Earthscan: New York, USA.
- Mirchi A, Madani K, Watkins D, Ahmad S. 2012. Synthesis of system dynamics tools for holistic conceptualization of water resources problems. *Water Resources Management* **26**(9): 2421–2442.
- Morecroft J. 1997. Strategic modelling and business dynamics. In *Systems Approaches to Managing Change: A Practical Guide*, Randers J (ed.). Springer: London; 25–85.
- Pruyt E. 2006. System dynamics and decision-making in the context of dynamically complex multi-dimensional societal issues. In *Proceedings of the 2006 Conference of System Dynamics*.
- Pruyt E. 2013. *Small system dynamics models for big issues: triple jump towards real-world dynamic complexity*. TU Delft Library: Delft, Netherlands.
- Qi C, Chang NB. 2011. System dynamics modeling for municipal water demand estimation in an urban region under uncertain economic impacts. *Journal of Environmental Management* **92**(6): 1628–1641.
- Qin HP, Su Q, Khu ST. 2011. An integrated model for water management in a rapidly urbanizing catchment. *Environmental Modelling and Software* **26**(12): 1502–1514.
- Randers J. 1980. Guidelines for model conceptualization. In *Elements of the System Dynamics Method*, Reynolds (ed.). MIT Press: Cambridge, MA; 117–139.
- Rashedi R, Hegazy T. 2016. Holistic analysis of infrastructure deterioration and rehabilitation using system dynamics. *Journal of Infrastructure Systems* **22**(1) 04015016(10).
- Rehan R, Knight MA, Haas CT, Unger AJA. 2011. Application of system dynamics for developing financially self-sustaining management policies for

- water and wastewater systems. *Water Research* 45(16): 4737–4750.
- Rehan R, Knight MA, Unger AJA, Haas CT. 2013. Development of system dynamics model for financially sustainable management of municipal watermain networks. *Water Research* 47(20): 7184–7205.
- Rehan R, Knight MA, Unger AJA, Haas CT. 2014. Financially sustainable management strategies for urban wastewater collection infrastructure—development of system dynamics model. *Tunneling and Underground Space Technology incorporating Trenchless Technology Research* 39: 116–129.
- Richardson GP, Paugh AL. 1981. *Introduction to system dynamics modeling with YNAMO*. MIT Press: Cambridge, Mass.
- Roberts M, Andersen A, Deal R, Garet M, Shaffer W. 1983. *Introduction to computer simulation: the system dynamics modeling approach*. Addison Wesley: Reading, MA.
- Rodrigues A, Bowers J. 1996. The role of system dynamics in project management. *International Journal of Project Management* 14(4): 213–220.
- Ryu JH, Contor B, Johnson G, Allen R, Tracy J. 2012. System dynamics to sustainable water resources management in the Eastern Snake Plain Aquifer under water supply uncertainty. *Journal of the American Water Resources Association* 48(6): 1204–1220.
- Saleh M, Oliva R, Kampmann CE, Davidsen PI. 2010. A comprehensive analytical approach for policy analysis of system dynamics models. *European Journal of Operational Research* 203(3): 673–683.
- Sheng N, Jia Y, Xo Z, Ho SL, Kan CW. 2013. A complex network based model for detecting isolated communities in water distribution networks. *Chaos* 23(4).
- Simonovic SP. 2002. *Managing water resources: methods and tools for a systems approach*. UNESCO Publishing: London, UK.
- Simonvic SP. 2001. World water dynamics: global modeling of water. *Journal of Environmental Management* 66(3): 249–267.
- Simonvic SP, Rajasekaram V. 2004. Integrated analyses of Canada's Water Resources: a system dynamics approach. *Canadian Water Resource Journal* 29(4): 223–250.
- Stave KA. 2003. A system dynamics model to facilitate public understanding water management options in Las Vegas, Nevada. *Journal of Environmental Management* 67(4): 303–313.
- Sterman JD. 2000. *Business dynamics: system thinking and modeling for a complex world*. McGraw-Hill/Irwin: New York, USA.
- Sterman JD, Oliva R, Linderman K, Bendely E. 2015. System dynamics perspectives and modeling opportunities for research in operations management. *Journal of Operations Management* 39–40: 1–5.
- Sun YF, Guo HC, Qu GY. 2002. A system dynamics approach for sustainable development in the Miyun Reservoir Area, China. *Chinese Geographical Science* 12(2): 157–165.
- Sun NZ, Sun A. 2015. *Model calibration and parameter estimation for environmental and water resource systems*. Springer: New York, USA.
- Susnik J, Vamvakeridou-Lyroudia LS, Savic PA, Kapelan Z. 2012. Integrated system dynamics modelling for water scarcity assessment: Case study of the Kairouan region. *Science of the Total Environment* 440: 290–306.
- Tidwell VC, Passell HD, Conrad SH, Thomas RP. 2004. System dynamics modelling for community-based water planning: application to Middle Rio Grande. *Aquatic Sciences* 66(4): 357–372.
- Walters J, Javernick-Will A. 2015. Long-term functionality of rural water services in developing countries: a system dynamics approach to understanding the dynamic interaction factors. *Environmental Science and Technology* 49(8): 5035–5043.
- Wang XJ, Zhang JY, Liu JF *et al.* 2011. Water resources planning and management based on system dynamics- a case study of Yulin city. *Environment, Development and Sustainability* 13(2): 331–351.
- Wang B, Cai Y, Yin XA, Tan Q, Hao Y. 2017. An integrated approach of system dynamics, orthogonal experimental design and inexact optimization for supporting water resources management under uncertainty. *Water Resources Management* 31(5): 1665–1674.
- Wei T, Lou I, Yang Z, Li Y. 2016. A system dynamics urban water management model for Macau, China. *Journal of Environmental Sciences* 50: 117–126.
- Winz I, Briersley G, Trowsdale S. 2009. The use of system dynamics simulation in water resources management. *Water Resources Management* 23(7): 1301–1323.
- Wirahadikusumah R, Abraham DM. 2003. Application of dynamic programming and simulation for sewer management. *Engineering Construction and Architectural Management* 10(3): 193–208.
- Wolstenholme E. 1990. *System enquiry: a system dynamics approach*. John Wiley & Sons: New York, USA.
- Wu G, Li L, Ahmad S, Chen X, Pan X. 2013. A dynamic model for vulnerability assessment of regional water resources in arid areas: a case study of Bayingolin, China. *Water Resources Management* 27(8): 3085–3101.
- Xu ZX, Takeuchi K, Ishidaira H, Zhang XW. 2002. Sustainability analysis for Yellow River water resources using the system dynamics approach. *Water Resources Management* 16(3): 239–261.
- Yang CC, Chang LC, Ho CC. 2008. Application of system dynamics with impact analysis to solve the problem of water shortages in Taiwan. *Water Resources Management* 22(11): 1561–1577.
- Zarghami SA, Gunawan I, Schultmann F. 2018. Integrating entropy theory and cospanning tree technique for redundancy analysis of water distribution

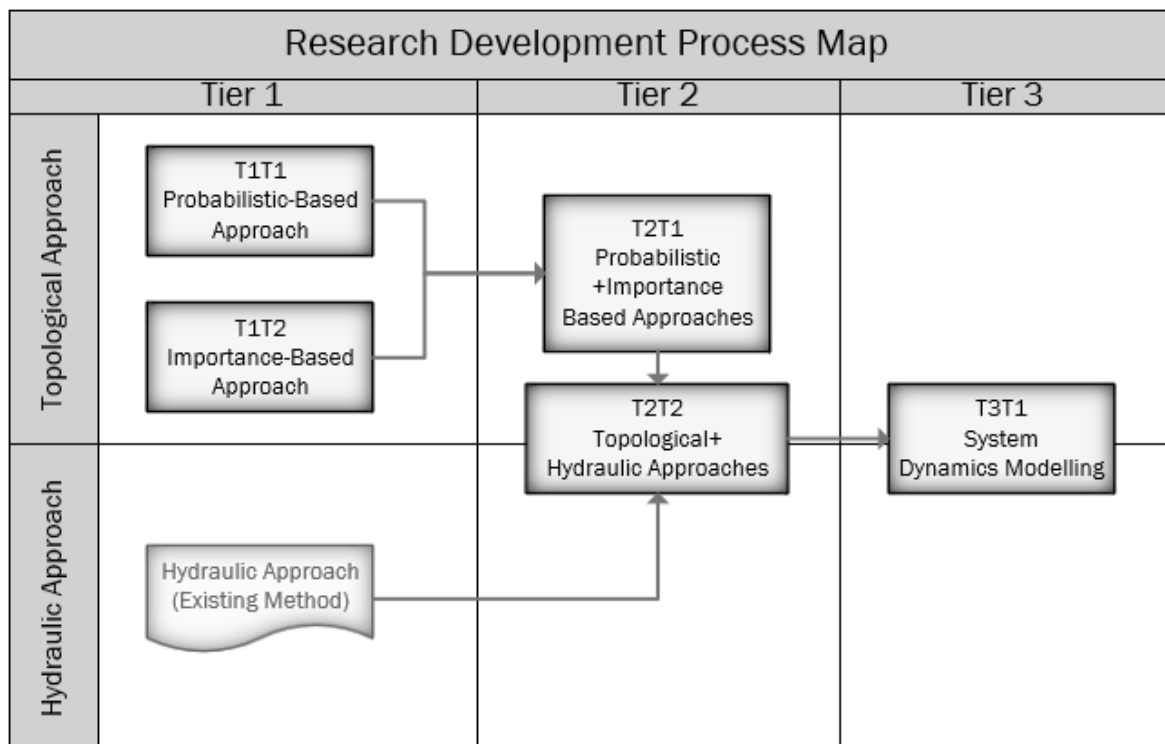
- networks. *Reliability Engineering and System Safety* **176**(2018): 102–112.
- Zhang XH, Zhang HW, Chen B, Chen CQ, Zhao XH. 2008. Water resources planning based on complex system dynamics: a case study of Tianjin city. *Communications in Nonlinear Science and Numerical Simulation* **13**(10): 2328–2336.
- Zlatanovic D. 2012. System dynamics model in management problems solving. *Economic Horizons* **14**(1): 25–38.

# *Chapter 3*

## Research Design and Methods

### 3. Research Design and Methods

This research introduces a three-tiered approach for reliability analysis of WDNs. Tier 1 is explicitly tied to evaluate the topological reliability of WDNs. Tier 2 will be developed based on the results of Tier 1, aimed at establishing an integrated framework for reliability analysis. Tier 3 will use the outputs generated by Tier 2 and will attempt to capture the dynamic nature of WDNs. In order to provide better visualisation of the conceptual framework of this research, Figure 1 illustrates the development process map for this research.



**Figure 1- The Development process map for the research**

### 3.1. Tier 1: Reliability analysis based on topological attributes

#### 3.1.1. Tier 1 Task 1 (T1T1): Probabilistic-based reliability analysis (enabling aim 1)

The probabilistic-based reliability analysis method has become a premier approach to assess the reliability of complex networks. In this approach, the question of network reliability is addressed based on measuring the probability that a network remains functional at any given time (Murray and Grubestic, 2007). In this spirit, most existing literature has evaluated the system vulnerability by measuring the overall probabilistic characteristics of the reliability problem (Rao and Nikan, 2016). These studies mainly simplify the concept of vulnerability by mapping a network into a graph consisting of a set of vertices and edges and subsequently adopting different graph invariants to quantify the probability of maintaining the connectivity achieved by the network (Wu *et al.*, 2013). Although researchers have successfully developed several innovative probabilistic methods for the purpose of the reliability assessment of complex networks, these methods lack the capability of achieving a closer adherence to WDNs. Additionally, most studies capture very generic topological properties of networks such as reachability, algebraic connectivity, Meshedness coefficient, clustering coefficient, and network density. The existing research ignores key topological features inherent within the layout of WDNs. To remedy this weakness, T1T1 introduces a novel two-stage approach to evaluate the reliability of WDNs. In stage 1, a deterministic method for assessing the vulnerability of each pipe is developed by employing redundancy, resilience and robustness strategies as indirect measures of reliability. Stage 2 uses the results of stage one and posits the informational entropy theory as a tool to measure the global vulnerability of the network as the opposite of reliability.



*3.1.2. Tier 1 Task 2 (T1T2): Importance-based reliability analysis (enabling aim 1)*

The importance-based reliability analysis approach assesses the reliability of a WDN based on the importance of its components. On contrary to the probabilistic-based approach, this approach does not address the probabilities of the system functionality. The focus of this approach is on the interconnections between network elements rather than on the elements themselves (Joyce *et al.*, 2010). In other words, this approach is concerned with the components importance as well as the consequences of component failures rather than the purely looking at the reliability of components. This method mainly employs the centrality measures in order to identify a network's most influential components (Lawyer, 2015). However, WDNs exhibit properties not shared by other networks. For example, centrality measures do not take into account the nodal attributes of a network, whereas a WDN is a network of source and demand nodes, each of which has its own attribute and function. This raises concerns about the effectiveness of applying conventional centrality measures to WDNs. In T1T2, an attempt will be made to generate new centrality metrics that stick more closely to WDNs features. Rather than an exclusive focus on network topology, as the conventional centrality metrics do, T1T2 will aim at incorporating different characteristics of nodes and pipes into centrality analysis.

**3.2. Tier 2: An integrated framework for reliability analysis of WDNs**

*3.2.1. Tier 2 Task 1 (T2T1): Coupling probabilistic and importance-based methods (enabling aim 2)*

It seems clear that an integrated framework that couples the two approaches proposed in T1T1 and T1T2 will be necessary to capture the complexity and diversity inherent in WDNs due to the following reasons. On the one hand, a component failure may be statistically unlikely owing to its high reliability but the consequences of failure on the network may be sufficiently large to pose major issues (Taylor *et al.*, 2006). On the other

hand, stand-alone use of the importance-based approach yields insufficient information with respect to the likelihoods of different components becoming inoperable (Bloomfield *et al.*, 2017). Accordingly, T2T1 seeks to couple the probabilistic-based and the importance-based techniques for reliability assessment of WDNs. For what concerns the coupling of these two approaches, a Fuzzy Inference System (FIS), an intelligent system that can respond efficiently to data inputs, is developed in this tier. The task of the proposed FIS model will be combining two concepts: reliability, as a measure of a component likely behavior, and centrality, as a measure of a component importance, by defining fuzzy rules in order to produce a vulnerability score, as the output parameter. In a nutshell, the FIS model will attempt to explain the linkage between reliability and centrality so as to evaluate the degree of vulnerability for WDNs elements.

### *3.2.2. Tier 2 Task 2 (T2T2): Integrating topological and hydraulic attributes (enabling aim 3)*

As stated earlier, neither an exclusive topological approach nor a pure hydraulic viewpoint can provide a comprehensive picture of WDNs vulnerability. On the one hand, pure topological measurements of the robustness WDNs are useful to describe the network structure, but they fail to properly characterize the network properties (Yazdani and Jeffrey, 2011). On the other hand, relying solely on the hydraulic properties of WDNs hinders a modeller to evaluate the vulnerability inherent within the layout of the network. On this premise, T2T2 will propose a combined topological and hydraulic approach to evaluate the reliability of WDNs. The new method complements the methods proposed in the preceding tasks (T1T1, T1T2, and T2T1) by incorporating different hydraulic attributes of WDNs such as demand and pressure head into the research. This is accomplished by developing a dual function method that serves to characterize both topological and hydraulic characteristics of WDNs. Moreover, by selecting a real-world WDN, the consequences of the increasing magnitude of water

demand and pressure head by removing different pipes with different topological attributes are evaluated. This gives a complete picture of the network reliability and vulnerability by measuring the extent to which the network performance degrades due to the simultaneous changes in the network layout as well as the network hydraulic attributes.

### **3.3. Tier 3: Dynamic modelling for reliability analysis of WDNs**

#### *3.3.1. Tier 3 Task 1 (T3T1): System dynamics modelling for robustness analysis of WDNs (enabling aim 4)*

WDNs are fundamentally complex dynamic systems with multiple interconnected elements that interact in a dynamic manner. Underlying feedback loops characterise the behaviour of these networks (Sheng *et al.*, 2013). Tier 1 and tier 2 provide a snapshot of a network at a given point in time, thereby addressing the question of system vulnerability statically. There is a need for a complementary approach to capture the dynamic interactions and feedback loops in WDNs. In this context, T3T1 attempts to take a system-level view of modelling and analysing these interactions and feedback loops that affect the vulnerability of WDNs. It is in this spirit that T3T1 provides a system dynamics modelling approach for reliability analysis of WDNs. The model is designed as a living entity that can be updated as its constituent variables change over time (Beall *et al.*, 2011). More precisely, T3T1 adopts the system dynamics modelling approach as a valid tool to determine the current vulnerability WDNs and its sensitivity to future changes by turning the vulnerability analysis proposed in tier 1 and tier 2 into stock and flow Diagram that allows simulation and scenario analysis.

# *Chapter 4*

## Probabilistic-Based Reliability Analysis

## 4. Probabilistic-Based Reliability Analysis

### 4.1. Paper 3: Exact reliability evaluation of infrastructure networks using graph theory

## Statement of Authorship

Title of Paper	Exact reliability evaluation of infrastructure networks using graph theory
Publication Status	<input type="checkbox"/> Published <input type="checkbox"/> Accepted for Publication <input checked="" type="checkbox"/> Submitted for Publication <input type="checkbox"/> Unpublished and Unsubmitted work written in manuscript style
Publication Details	Zarghami S.A., Gunawan, I., & Schultmann, F. (2019). Exact reliability evaluation of infrastructure networks using graph theory. <i>Quality and Reliability Engineering International</i> . Under Review.

### Principal Author

Name of Principal Author (Candidate)	Seyed Ashkan Zarghami				
Contribution to the Paper	Design the model and computational framework- Developing the theory- Proposing a new method- Performing the analytic calculations- Demonstrating the proposed method on case studies-Discussion of results- Identifying avenues for future work- Writing the manuscript				
Overall percentage (%)	85%				
Certification:	This paper reports on original research I conducted during the period of my Higher Degree by Research candidature and is not subject to any obligations or contractual agreements with a third party that would constrain its inclusion in this thesis. I am the primary author of this paper.				
Signature	<table border="1" style="width: 100%;"> <tr> <td style="width: 80%;"></td> <td style="width: 20%;">Date</td> </tr> <tr> <td></td> <td>19/05/2019</td> </tr> </table>		Date		19/05/2019
	Date				
	19/05/2019				

### Co-Author Contributions

By signing the Statement of Authorship, each author certifies that:

- i. the candidate's stated contribution to the publication is accurate (as detailed above);
- ii. permission is granted for the candidate to include the publication in the thesis; and
- iii. the sum of all co-author contributions is equal to 100% less the candidate's stated contribution.

Name of Co-Author	Associate Professor Indra Gunawan				
Contribution to the Paper	Supervising development of the work- Verifying the numerical results- Evaluation of the manuscript- Helping to edit the manuscript-Final approval of the version to be published				
Signature	<table border="1" style="width: 100%;"> <tr> <td style="width: 80%;"></td> <td style="width: 20%;">Date</td> </tr> <tr> <td></td> <td>8/8/19</td> </tr> </table>		Date		8/8/19
	Date				
	8/8/19				

Name of Co-Author	Professor Frank Schultmann				
Contribution to the Paper	Supervising development of the work –Helping to edit the manuscript- Final approval of the version to be published				
Signature	<table border="1" style="width: 100%;"> <tr> <td style="width: 80%;"></td> <td style="width: 20%;">Date</td> </tr> <tr> <td></td> <td>01/08/2019</td> </tr> </table>		Date		01/08/2019
	Date				
	01/08/2019				

Please cut and paste additional co-author panels here as required.



**Exact reliability evaluation of infrastructure networks using graph theory**

Journal:	<i>Quality and Reliability Engineering International</i>
Manuscript ID	Draft
Wiley - Manuscript type:	Research Article
Date Submitted by the Author:	n/a
Complete List of Authors:	Zarghami, Seyed Ashkan; University of Adelaide, Entrepreneurship, Commercialisation & Innovation Centre (ECIC) Gunawan, Indra; Entrepreneurship, Commercialisation and Innovation Centre (ECIC) Schultmann, Frank; University of Adelaide, Entrepreneurship, Commercialisation & Innovation Centre (ECIC)
Keywords:	Graph theory, Infrastructure networks, Reliability, Reliability Block Diagram, Spanning tree

SCHOLARONE™  
Manuscripts

# Exact reliability evaluation of infrastructure networks using graph theory

## *Abstract*

Reliability analysis of Infrastructure Networks (INs) is gaining recognition in research literature. However, most of the work on reliability evaluation of INs has focused on simulation analysis and, therefore, unable to calculate the exact reliability. Additionally, these methods lack the capability of achieving a closer adherence to INs. The presented paper aims at filling these gaps by simplifying the process of computing the exact reliability of an IN through the decomposition of the network into a set of series and parallel configuration of its elements. In exemplifying the method, an illustrative example is presented and a brief discussion on the usefulness and limitation of the method is described.

*Keywords:* Graph theory; Infrastructure networks; Reliability; Reliability Block Diagram; Spanning tree.

## **1. Introduction**

The economy, welfare, public health and security of a nation heavily rely on designing, constructing and maintaining reliable Infrastructure Networks (INs). The term “Infrastructure Networks” generally refers to lifeline systems, such as transportation, power, water and gas networks. INs contain a collection of identifiable assets, where assets are source nodes, sink nodes or edges. Table 1 exemplifies these assets in different INs.

**Table 1.** Examples of nodes and edges in different INS

[Please Insert Near Here]

The growing complexity of INs due to the dynamic nature of today’s society is requiring researchers and practitioners to evaluate the performance of INs to ensure the continued provision of public goods (Too, 2012). Reliability is one of the most popular indicators for evaluation of INs and has attracted considerable international

1  
2  
3  
4 research interests in recent years (Kobayashi *et al.*, 2009). The reliability of INs is  
5 concerned with the ability of the network to provide continuity of operation. Generally  
6 speaking, reliability is a probabilistic measure of components referring to the  
7 probability that a network remains functional at any given time (Murray and Grubestic,  
8 2007). Gunawan *et al.* (2017) compiled different definitions of reliability from existing  
9 literature with emphasis on stochastic rather than deterministic nature of reliability.  
10  
11  
12  
13  
14

15 Much effort is currently devoted to evaluating the reliability of complex systems and  
16 several innovative methods have been developed since the past three decades. These  
17 methods can be broadly categorized into two groups: non-simulation-based methods  
18 and simulation-based methods (Lin *et al.*, 2018). Non-simulation-based methods (e.g.,  
19 minimal path vectors; binary decision diagram; matrix-based System reliability;  
20 ordered binary decision diagram; recursive decomposition algorithm; fault-tree  
21 analysis; reliability block diagram) are based on computing the probability of system  
22 events. These methods are useful for determining the exact reliability of relatively  
23 small networks because generally the states of all components composing the system  
24 are considered. Thus, as the number of system components increase, the size of the  
25 system reliability problem increases exponentially (Kim and Kang, 2013). Simulation-  
26 based methods (e.g., cross-entropy method; discrete event simulation; Bayesian  
27 method; fuzzy Bayesian system reliability; line sampling; Monte Carlo simulation  
28 method; subset simulation; weighted average simulation) are centered on model-based  
29 approaches and aim to imitate the operation of a system over time. These approaches  
30 provides the ability to better study the behavior of complex systems by determining  
31 the overall probabilistic characteristics of the reliability problem (Saling and White Jr,  
32 2013; Rao and Naikan, 2016). Simulation-based methods are often used for the  
33 reliability assessment of large systems because unlike the non-simulation-based  
34 methods, the size of system reliability problem is essentially independent of the  
35 number of system components.  
36  
37  
38  
39  
40  
41  
42  
43  
44  
45  
46  
47  
48  
49  
50

51 Although the two categories of methods, as described above, have been successfully  
52 developed and applied for the purpose of reliability assessment of complex systems,  
53 these methods lack the capability of achieving a closer adherence to INs. These  
54 methods generally ignore the valuable characteristics of INs that can be inferred  
55 through their topological properties. Furthermore, the literature on quantifying the  
56  
57  
58  
59  
60



1  
2  
3  
4 exact reliability of networks is sparse (Rajkumar and Goyal, 2016) and most of the  
5 work on reliability evaluation of INs has focused on simulation analysis and therefore  
6 unable to calculate the exact reliability. We advocate the idea that the accuracy in the  
7 reliability evaluation should not be sacrificed to achieve a reduced computational time.  
8  
9

10  
11 The theme of this paper is to develop a novel method for the exact reliability evaluation  
12 of INs by using a graph theory tool, called Spanning Tree Technique (STT). By  
13 adopting the STT, we endeavor to adhere to a key topological characteristic of INs  
14 known as the network connectivity. Network connectivity is concerned with the  
15 probability that nodes of the network remain connected (Günneç and Salman, 2011).  
16 In fact, the overall network performance highly depends on the connectivity of the  
17 network as a critical property (Cheng *et al.*, 2017). Therefore, in this paper, reliability  
18 is defined as the connectivity reliability, which is a reliability measurement criterion  
19 referring to the probability of connectivity achieved by a network (Wu *et al.*, 2013).  
20 The terms, reliability, and connectivity reliability are used interchangeably throughout  
21 this work. Moreover, in order to visualize the functioning state of a network given the  
22 functioning state of its components, this work attempts to develop a refined Reliability  
23 Block Diagram (RBD), which accounts for the physical layout of a network's  
24 components and is therefore readily applicable in the context of INs. By situating this  
25 work in the graph theory context, more intuitive and realistic representation of INs in  
26 the reliability theory domain is offered.  
27  
28  
29  
30  
31  
32  
33  
34  
35  
36  
37  
38

39 This research makes the following contributions: First, it simplifies the process of  
40 evaluating the overall reliability of INs by constructing a refined RBD. Second, the  
41 proposed method reduces the computational efforts for calculating the exact reliability  
42 of INs. Third, this work is the first application of the STT in the reliability engineering  
43 filed.  
44  
45  
46  
47

48 The remainder of this paper is organized as follows: Section 2 develops the proposed  
49 reliability computation method by incorporating STT into the standard RBD. Section  
50 3 presents an illustrative example to illustrate the applicability of the proposed method  
51 followed by a discussion on results. Conclusions and possible avenues for future work  
52 are outlined in Section 4.  
53  
54  
55  
56  
57

## 58 **2. The Present Approach**

59  
60

1  
2  
3  
4 The present approach consists of three main steps: (1) generating all spanning trees of  
5 the given network, (2) incorporating spanning trees into the standard RBD, and (3)  
6 quantifying the reliability. Before discussion on the development of the proposed  
7 method, we first recall the notion of RBD.  
8  
9

### 10 11 **2.1. Reliability Block Diagram (RBD)** 12

13 The introduction section in this paper presents some of the current approaches for  
14 assessing the reliability of complex systems. Of these, for the proposed model, the  
15 RBD is chosen for visualizing and facilitating the process of reliability evaluation.  
16 RBD is a logical diagram and graphical representation of the components of a system,  
17 which visually depicts what is required for the system to function (Rausand, 2014).  
18 RBD consists of rectangles that represent functional blocks connected by lines which  
19 indicate the relationships of the blocks. The functional blocks are often connected in  
20 three configurations: series, parallel, or series-parallel as shown in Fig.1.  
21  
22  
23  
24  
25  
26

27  
28 **Fig.1.** Conceptual Sketch of RBD  
29

30 [Please Insert Near Here]  
31  
32

33 As can be observed in Fig.1, the diagram contains one input node located at the left  
34 side of the diagram and one output node at the right side of the diagram, whose  
35 operation depends on series and/or parallel configurations of the functional blocks. The  
36 basic concept of the RBD is that a system with series structure of its components  
37 requires that each component must be functioning for overall system to be operational,  
38 whereas a system contains components connected as a parallel structure requires at  
39 least one component to be functional for overall system to be operational (Becker and  
40 Hansen, 1983).  
41  
42  
43  
44  
45  
46

47 RBD is now considered as a common diagramming and calculation tool to analyze  
48 complex systems. RBD addresses the relationship between system reliability and  
49 components reliability and assesses the overall system reliability based on the  
50 reliability of its components (Hong and Meeker, 2014). It has found its application in  
51 wide areas. For example, RBD has been employed to evaluate the reliability of  
52 electrical power and protection systems (Zhang *et al.*, 2006; Ridwan *et al.*, 2010).  
53 Bourouni (2013) used RBD to assess the reliability of osmosis plants and emphasized  
54  
55  
56  
57  
58  
59  
60

1  
2  
3  
4 the superiority of RBD over the fault tree analysis method. Dernlugkam and  
5 Chokchairungroj (2015) performed the reliability analysis of the ignition system of the  
6 rocket platform by coupling the failure mode and effect analysis and RBD. Ding *et al.*  
7 (2014) generated RBDs of safety architectures for reliability assessment of safety-  
8 related systems by verifying safety integrity level. In the work of Jin *et al.* (2015), the  
9 reliability of safety instrumented systems was evaluated by mapping the system  
10 components into RBD.  
11  
12  
13  
14  
15

16 Although RBD is capable of providing a success-oriented view of the system, not all  
17 systems can be mapped into an RBD. INs are mainly structured in a very complex  
18 manner and are not necessarily those of with series/parallel or series-parallel  
19 configurations, hence it is difficult to analyze their reliability using the standard RBD.  
20 The solution to this problem is provided in this work by refining the standard RBD by  
21 adopting a graph theory tool, called Spanning Tree Technique (STT). In the proposed  
22 method, the reliability of INs is obtained by breaking the total network configuration  
23 down into combinations of multiple series and parallel arrangements using the STT.  
24  
25  
26  
27  
28  
29

## 30 **2.2. Incorporating spanning trees into RBD**

31  
32 A spanning tree is a tree shape subgraph that contains every vertex of the original  
33 graph. More precisely, a spanning tree is a graph with exactly one path between any  
34 two distinct nodes. The concept of spanning tree has been discussed elsewhere (see,  
35 for example, Saha Ray, 2013), it will not be further described in this work.  
36  
37  
38  
39

40 As stated earlier, the architecture of an IN structure is not generally one of the simple  
41 forms with series and/or parallel configurations of its components. It becomes difficult  
42 to compute the exact reliability of a network with such a complex structure. We adopt  
43 the STT to simplify the process of computing the exact reliability of INs. In doing so,  
44 we first model an IN as a weighted, undirected, and connected graph  $G=(V,E,\omega_e)$ , in  
45 which numerical values of  $\omega_{e \in E}$ , representing the reliability of each edge, are assigned  
46 to the edges of the graph. Each spanning tree of graph  $G$  represents an extreme  
47 connectivity case, where specific edges are subjects of interest. Therefore, the problem  
48 is simplified through the identification of the relevant edges with more contribution to  
49 the connectivity of the network.  
50  
51  
52  
53  
54  
55  
56  
57  
58  
59  
60

Obviously, all components of a given spanning tree must function in order to satisfy the minimum connectivity requirement of the network. This description resembles the series arrangement of elements described earlier. Furthermore, since each spanning tree of a network represents an extreme connectivity case, thus the network functions whenever at least one of its spanning trees works. This intuitive description is very reminiscent of the definition of the parallel configuration introduced in the previous subsection. Therefore, the connectivity of a network can be represented as a parallel system of its spanning trees, while each spanning tree consists of the series configuration of its edges. As a result, the complex structure of any IN can be simplified by breaking down the network into the combination of series edges and parallel spanning trees.

### 2.3. Quantifying the reliability

Once the set of all spanning trees is known, the network reliability can be quantified based on the configuration of spanning trees and according to success or failure of each individual spanning tree. Let  $T = \{T_1, T_2, \dots, T_q\}$  be the set of all spanning trees of the network,  $T_j$  is functioning if all its  $p$  edges are functioning, hence the reliability of  $T_j$  is that of a series system. Furthermore, the operation of at least one spanning tree of the set of  $q$  distinct  $T$  entails the operation of the network. As per convention, we define the structure function of the system as a binary function that describes the status of the system given the status of each component. The structure function takes on the value of 1 if the system is functioning and the value of zero otherwise. Given the above mentioned, the simplest possible form of the structure function of the network can be stated as follows:

$$\Phi(x) = 1 - \prod_{j=1}^q (1 - \prod_{i \in T_j} x_i) \quad (1)$$

The following equation holds true since the reliability in this paper is concerned with the probability of no failure occurs in the network.

$$R = \Pr [\Phi(x) = 1] \quad (2)$$

where  $R$  denotes the reliability of the network.

Since an IN is functioning if at least  $k$ -out of- $n_s$  source nodes are functioning at any given time, therefore, the proposed approach addresses a  $k$ -out of- $n$  system reliability model. In the  $k$ -out of- $n_s$  reliability model, the network is decomposed into different choices of  $k$  source nodes as operational conditions, meaning the system requires  $k$  components as a minimum to operate (Higashiyama, 2004). By assuming that each source node has identical and independent distributed failure time, the total number of different combinations of  $n_s$  source nodes,  $n_\Omega$ , taken  $k \geq k_s$  at a time can be calculated by Eq. (3).

$$n_\Omega = \sum_{k=k_s}^{n_s} \binom{n_s}{k} \quad (3)$$

At this point, a modified RBD, showing  $k$ -out of- $n_s$  structure of the network, is constructed by joining multiple intersecting edges in a single diagram. The intersecting edges represent multiple functional pathways between source and sink nodes. The graphical representation of this layout is shown in Fig. 2.

**Fig.2.** The modified RBD

[Please Insert Near Here]

Up to this point, we have computed the reliability of a given network event. This network event represents a single functional pathway between a source node and all sink nodes. Thus, the final step is to extend the method further to evaluate the overall reliability of the network with the aid of the refined RBD, as shown in Fig.2.

Let  $\Omega = \{\Omega_1, \Omega_2, \dots, \Omega_m\}$  be the set of all possible arrangements of  $k \geq k_s$  out of  $n_s$  source nodes, for the successful operation of the network at least 1 out of  $n_\Omega$  intersecting edges must function, hence the reliability is equal to the probability that at least one intersecting edge of the refined RBD works. In other words, various network events with the assigned reliability of  $R^{\Omega_i}$  form a parallel system, hence the overall reliability of the system,  $R_T(G)$ , is transferred into the calculation of the probability of the event that all the intersecting edges do not fail. Therefore,  $R_T(G)$  can be obtained from the following well-known expression:

$$R_T(G) = 1 - \prod_{i=1}^{n_\Omega} (1 - R^{\Omega_i}) \quad (4)$$

The procedures of the proposed evaluation approach can be summarized in the form of an algorithm as shown in Fig.3.

**Fig.3.** Flowchart for the proposed method

[Please Insert Near Here]

### 3. An Illustrative Example

The proposed method is now demonstrated on an illustrative infrastructure network from Zarghami *et al.* (2018a). The network consists of eight edges, two source nodes, and five sink nodes. We assume three different network events such that either or both source nodes are connected to all sink nodes. Fig.4 illustrates the layout of the illustrative example and the aforementioned network events.

**Fig.4.** The layout of the illustrative example and the network events

$\Omega_1$ : Both source nodes are functioning

$\Omega_2$ & $\Omega_3$ : Either of source nodes is functioning

[Please Insert Near Here]

For convenience, the corresponding sets of these events are listed as follows:  $\Omega_1 = \{1,7\}$ ,  $\Omega_2 = \{1\}$ ,  $\Omega_3 = \{7\}$ , where the numbers in braces denote the nodes number.

#### 3.1. Quantifying the exact reliability

The network is mapped into an undirected weighted graph. *SageMath 6.10*, an open-source mathematical software system is employed to enumerate all spanning trees of the network. Fig.5 depicts all eleven spanning trees of the network for the event  $\Omega_1$ . In Fig.5, spanning trees are represented by solid lines and irrelevant edges are indicated by dashed lines.

**Fig.5.** All spanning trees of event  $\Omega_1$

[Please Insert Near Here]

By creating all the spanning trees in the previous step, it is now possible to generate all intersecting edges of the modified RBD. The diagram consists of three input nodes,  $\Omega_1, \Omega_2$  and  $\Omega_3$ , representing three different network events with respect to the functionality of the source nodes. These input nodes flow to the functional blocks and conclude to the central node  $D = \{2,3,4,5,6\}$ . The functional block of each intersecting edge is represented as a parallel system of eleven spanning trees, whereas each spanning tree of the events  $\Omega_1, \Omega_2$  and  $\Omega_3$  consists of the series combination of 6,5 and 5 edges, respectively.

By the approach introduced in the previous section, the reliability calculation of the network for  $\Omega_1$ , can be summarized in Table 2.

**Table 2.** Reliability of each spanning tree for  $\Omega_1$

[Please Insert Near Here]

By using Eq. (2) and substituting the reliability values of the spanning trees, we obtain  $R^{\Omega_1} = 0.9171$ , where  $R^{\Omega_1}$  is the reliability of the network when both source nodes 1 and 7 are functioning.

The similar calculations can be performed to obtain the reliabilities of  $\Omega_2$  and  $\Omega_3$ , as follows:  $R^{\Omega_2} = 0.9601$ ,  $R^{\Omega_3} = 0.9603$ , where  $R^{\Omega_2}$  and  $R^{\Omega_3}$  represent the event where either if source nodes 1 or 7 is functioning.

Now it is possible to quantify the exact reliability of the network that refers to the probability of an event where at least one of nodes 1 and 7 is connected to all sink nodes. This probability can be easily estimated by using Eq. (4) as follows:

$$R_T(G) = 1 - (1 - R^{\Omega_1})(1 - R^{\Omega_2})(1 - R^{\Omega_3}) = 0.999861402$$

In order to provide better visualization of the proposed method, Fig. 6 illustrates the different procedural steps used applied to the illustrative example.

**Fig.6.** Overview of the proposed method demonstrated on the illustrative example

[Please Insert Near Here]

### 3.2. Discussion

The conventional reliability analysis methods compute the exact reliability of a system by considering the states of all  $n$  constituent components of a system, thus one must consider all possible  $2^n$  system states. As illustrated in this section, computational efforts have been substantially decreased by substituting the number of all spanning trees (11) for the number of all possible states of the network ( $2^8 = 256$ ). This is because the proposed method significantly reduces the computation time by focusing on the network connectivity and subsequently removing the irrelevant edges from the process of reliability calculation.

As illustrated in Fig.6, the proposed method not only simplifies the process of computing the exact reliability of INs, but also provides a more intuitive and realistic visualization of these networks in the reliability engineering domain due to the following features:

1. The proposed method takes into consideration multiple network events, each of which represented by an intersecting edge. Each intersecting edge implies a specific functioning condition of the network. The multiplicity of intersecting edges demonstrates the redundancy of the network and refers to the existence of alternative independent paths between the source and sink nodes.
2. On contrary to the standard RBD, where input and output nodes are featureless objects and only the relationships between functional blocks are visualized, this method divides sink and source nodes into different subsets and demonstrates them at once in a single diagram. The proposed method indicates what is required for maintaining the network connectivity by illuminating the relationships amongst spanning trees and visualizing a flow originating from a given combination of source nodes moving through different spanning trees and ending to the central node.

### 3.3. Sensitivity analysis

Component reliability is the underlying driver for network reliability. The sensitivity of the overall network reliability to component reliability is defined as the partial



1  
2  
3  
4 derivative of the total reliability with respect to the component reliability (Ross *et al.*,  
5 2001). Sensitivity analysis can be performed to assess the appropriateness of the  
6 method and to comprehend the strength of the conclusions being drawn from the  
7 method and is also useful in gaining confidence in the results of analysis by providing  
8 an understanding how the method responds to changes in the input (Liburne and  
9 Tarantola, 2009; Saliccioli *et al.*, 2016). In this section, sensitivity analysis for the  
10 overall network reliability with a change in the reliability of individual components for  
11  $\Omega_1$ , is performed. We consider a wide possible range of reliability values that account  
12 for various factors such as random failures, catastrophic events, and malicious attacks  
13 which affect INs in the real world. Starting at 0.1, the reliability value of each  
14 component is incremented in steps of 0.1 up to 1.0. The results obtained from the  
15 sensitivity analysis are shown in Fig. 7.

26 **Fig.7.** Network reliability vs. component reliability

27  
28 [Please Insert Near Here]

29  
30  
31 Examination of Fig. 7 reveals that network reliability is most sensitive to the reliability  
32 of bridges in the network (components 1 and 8). This can be attributed to the non-  
33 redundant characteristic of these components. The network reliability is less sensitive  
34 to the reliability of component 5 when compared to other components. This is mainly  
35 ascribed to the existence of many alternative paths that compensates for the loss of  
36 reliability in this component. The components group (2,3,4) and (6,7) demonstrate a  
37 similar gradual upward trend in the network reliability with respect to increase in their  
38 reliability. This can be attributed to the rather similar position of these components in  
39 the cycle where they are located. The similar trend was observed for  $\Omega_2$  and  $\Omega_3$ , though  
40 they are not presented here. The consistency between the numerical values of the  
41 sensitivity analysis and the intuitive explanations, presented in this section, verifies the  
42 robustness of the method and gains confidence in the results of the reliability analysis  
43 proposed in this research.

#### 4. Conclusion

54  
55  
56  
57  
58  
59  
60

1  
2  
3  
4 Much of the current literature, addressing the reliability of complex systems, focuses  
5 on the approximate estimation of the reliability. Additionally, the exact reliability of  
6 INs as complex constructs cannot be straightforwardly computed using the  
7 conventional methods. To this end, the present paper has attempted to represent a new  
8 step towards computing the exact reliability of INs. The main innovation is the  
9 incorporation of STT into the standard RBD, which brings the advantages of simplicity  
10 and clarity for evaluating the reliability of INs and facilitates the computation of  
11 system reliability from components reliability. The proposed method is based on the  
12 connectivity nature of INs, thereby offering a more intuitive and realistic  
13 representation of these networks in the reliability theory domain.

14  
15  
16  
17  
18  
19  
20  
21 The proposed method was applied to an illustrative IN from the literature, where  
22 various combinations of functional source nodes were considered. In addition, the  
23 paper has compared the effectiveness of the refined RBD, concluding that it provides  
24 a more realistic visualization of INs in the reliability engineering field. Furthermore, a  
25 sensitivity analysis was conducted to investigate the sensitivity of the overall network  
26 reliability to its components reliability. The consistency of the proposed method was  
27 verified by the results obtained from the sensitivity analysis.

28  
29  
30  
31  
32  
33  
34 As pointed out by Papadakis and Kleindorfer (2005), network topology dependencies  
35 plays a key role in physical asset maintenance of INs. The topological reliability  
36 analysis proposed herein can be used as a decision-support tool that enables  
37 practitioners to identify and prioritize vulnerabilities in order to design and implement  
38 a cost-effective maintenance strategy.

39  
40  
41  
42  
43  
44 The computation time for the illustrative example was fairly short, due to the small  
45 size of the network. However, enumerating all spanning trees of the large networks  
46 presents a challenge, which is generally a time-consuming step. Forthcoming work  
47 might usefully seek to propose a method, which further decreases the computational  
48 efforts, in order to broaden the capability of the model for the reliability evaluation of  
49 large networks. Additionally, as suggested by Zarghami *et al.* (2018b), INs are  
50 fundamentally complex dynamics networks, as a result, the reliability of these  
51 networks may vary over time. This work provides a snapshot of the network reliability  
52 at a given point in time. Further research might seek to develop a dynamic model for  
53  
54  
55  
56  
57  
58  
59  
60

reliability analysis of INs that can be updated as its constituent variables change over time.

## References

1. Becker, P.W. and Hansen, E.B. (1983), "On systems' reliability and redundancy", *International Journal of General Systems*. Vol.9 No.4, pp. 261-266.
2. Bourouni, K. (2013), "Availability assessment of reverse osmosis plant: Comparison between reliability block diagram and fault tree analysis methods", *Desalination*, Vol.313, pp. 66-76.
3. Cheng, M.X., Yi, L. and Sadler, BM. (2017), "Network connectivity assessment and improvement through relay node deployment", *Theoretical Computer Science*, Vol.666, pp. 86-101.
4. Dernlugkam, N. and Chokchairungroj, P. (2015), "Reliability determination of ignition system of rocket platform using reliability block diagram and FEMA analysis", *Vibroengineering Procedia*, Vol.6, pp.115-120.
5. Ding, L., Wang, H., Kang, K. and Wang, K. (2014), "A novel method for SIL verification based on system degradation using reliability block diagram", *Reliability Engineering and System Safety*, Vol.132, pp.36-45.
6. Gunawan, I., Schultmann, F. and Zarghami S.A. (2017), "The four Rs performance indicators of water distribution networks: A review of research literature", *International Journal of Quality & Reliability Management*, Vol.34 No.5, pp.720-732.
7. Günneç, D., and Salman, S. (2011), "Assessing the reliability and the expected performance of a network under disaster risk", *OR Spectrum*, Vol.33 No.3, pp. 499-523.
8. Hong, Y., and Meeker, W.Q. (2014), "Confidence interval procedures for system reliability and applications to competing risk models", *Lifetime Data Analysis*, Vol.20 No.2, pp. 161-184.
9. Jin, J., Pang, L., Zhao, S., and Hu, B. (2015), "Quantitative assessment of probability of failing safely for the safety instrumented system using reliability block diagram method", *Annals of Nuclear Energy*, Vol. 77, pp.30-34.
10. Higashiyama, Y. (2004), "A method for exact reliability of consecutive 2 out-of- $(r, r)$ -from- $(n, n)$ :  $F$  systems", *International Transactions in Operational Research*, Vol.11 No.2, pp.217-224.
11. Kim, Y. and Kang W.H. (2013), "Network reliability analysis of complex systems using a non-simulation-based method", *Reliability Engineering and System Safety*, Vol.110, pp.80-88.
12. Kobayashi, K., Morohosi, H., and Oyama, T. (2009), "Applying path-counting methods for measuring the robustness of the network-structured system", *International Transactions in Operational Research*, Vol.16 No.3, pp.371-389.
13. Liburne, L. and Tarantola, S. (2009), "Sensitivity analysis of spatial models", *International Journal of Geographical Information Science*. Vol.23 No.2, pp.151-168.
14. Lin, S., Wang, Y., Jia, L., and Zhang, H. (2018), "Reliability assessment of complex electromechanical systems: A network perspective", *Quality and Reliability Engineering International*, Vol.34 No.5, pp.772-790.

15. Murray, A.T and Grubestic, T.H. (2007), "Overview of Reliability and Vulnerability in Critical Infrastructure" in Murray and Grubestic (Ed.), *Critical Infrastructure: Reliability and Vulnerability*, Springer- Verlag, Heidelberg, Berlin, Germany, pp.1-8.
16. Papadakis, I., and Kleindorfer, P.R. (2005), "Optimizing infrastructure network maintenance when benefits are interdependent", *OR Spectrum*, Vol.27 No.1, pp. 63-84.
17. Rajkumar, S. and Goyal, N.K. (2016), "Reliability analysis of multistage interconnection networks", *Quality and Reliability Engineering International*, Vol.32 No.8, pp.3051-3065.
18. Rao, M.S. and Naikan, V.N.A. (2016). "Review of simulation approaches in reliability and availability modeling", *International Journal of Performability Engineering*, Vol.12 No.4, pp. 369-388.
19. Rausand, M. (2014), *Reliability of Safety-Critical Systems: Theory and Applicatio.*, John Wiley & Sons, Inc., Hoboken, New Jersey, USA.
20. Ridwan, M.I., Yen, K.L., Musa, I.R.M. and Yunus, B. (2010), "Reliability and availability assessment of transmission overhead line protection systems using reliability block diagram", in *proceedings of the 2010 IEEE International Conference on Power and Energy*, pp.964-969.
21. Ross, D.P., Welch, G.V. and Willis, H.L. (2001), "Sensitivity of system reliability to component aging in metropolitan, urban, and rural areas", in *Proceedings of the 2001 IEEE/PES Transmission and Distribution Conference and Exposition*, Vol.2, pp.749-753.
22. Saha Ray, S. (2013), *Graph Theory with Algorithms and its Applications: In Applied Science and Technology*, Springer, New Delhi, India.
23. Saliccioli, J.D., Curtain, Y., Komorowski, M. and Marshall D.C. (2016), "Sensitivity analysis and model validation", in MIT Critical Data (Ed.), *Secondary Analysis of Electronic Health Record*, Springer, Cham, Switzerland, pp.263-271.
24. Saling, K.G., and White Jr, K.P. (2013), "Integrating the probabilistic design and rare-event simulation into the requirements engineering process for high-reliability systems", *International Transactions in Operational Research*, Vol.20 No.4, pp.515-531.
25. Too, E. (2012), "Infrastructure asset: developing maintenance management capability", *Facilities*, Vol.30(5-6), pp.234-253.
26. Wu, L., Tan, Q. and Zhang, Q. (2013), "Network connectivity entropy and its application on network connectivity reliability", *Physica A: Statistical Mechanics and its Applications*, Vol.392 No.21, pp.5536-5541.
27. Zarghami, S.A., Gunawan, I., and Schultmann, F. (2018a), "Integrating entropy theory and cospanning tree technique for redundancy analysis of water distribution networks", *Reliability Engineering and System Safety*, Vol. 176, pp.102-112.
28. Zarghami, S.A., Gunawan, I., and Schultmann, F. (2018b), "System dynamics modelling process in water sectors: a review of research literature", *Systems Research and Behavioral Science*, Vol.35 No.6, pp.776-790.
29. Zhang, P., Portillo, L. and Kezunovic, M. (2006), "Reliability and component importance analysis of all-digital protection systems", in *proceedings of the 2006 IEEE PES Power Systems Conference and Exposition*, pp.1380-1387.

**Table 1.** Examples of nodes and edges in different INS

Infrastructure Networks	Source nodes	Sink nodes	Edges
Water distribution systems	Reservoirs, Tanks, Rivers	Consumers	Water pipelines
Power transmission networks	Power plants	Consumers	Transmission lines
Gas transmission and distribution systems	Gas wells, Gas generators	Consumers	Gas pipelines
Transportation systems	Airports, Rail stations	Cities, Suburbs	Highways, Railways

**Table 2.** Reliability of each spanning tree for  $\Omega_1$ 

$T_j^{\Omega_1}$	Components	$\prod x_i$	$1 - \prod x_i$
$T_1^{\Omega_1}$	$x_1x_3x_4x_6x_7x_8$	0.204831	0.795168988
$T_2^{\Omega_1}$	$x_1x_3x_4x_5x_7x_8$	0.205912	0.794088085
$T_3^{\Omega_1}$	$x_1x_2x_3x_5x_7x_8$	0.191667	0.808332935
$T_4^{\Omega_1}$	$x_1x_3x_4x_5x_6x_8$	0.211779	0.788220853
$T_5^{\Omega_1}$	$x_1x_2x_3x_5x_6x_8$	0.192679	0.807321499
$T_6^{\Omega_1}$	$x_1x_2x_3x_6x_7x_8$	0.210636	0.78936406
$T_7^{\Omega_1}$	$x_1x_2x_4x_6x_7x_8$	0.201237	0.798762514
$T_8^{\Omega_1}$	$x_1x_2x_3x_4x_6x_8$	0.200619	0.799381451
$T_9^{\Omega_1}$	$x_1x_2x_3x_4x_7x_8$	0.202299	0.797700575
$T_{10}^{\Omega_1}$	$x_1x_2x_4x_5x_6x_8$	0.208064	0.791936277
$T_{11}^{\Omega_1}$	$x_1x_2x_4x_5x_7x_8$	0.198169	0.801831338

1  
2  
3  
4  
5  
6  
7  
8  
9  
10  
11  
12  
13  
14  
15  
16  
17  
18  
19  
20  
21  
22  
23  
24  
25  
26  
27  
28  
29  
30  
31  
32  
33  
34  
35  
36  
37  
38  
39  
40  
41  
42  
43  
44  
45  
46  
47  
48  
49  
50  
51  
52  
53  
54  
55  
56  
57  
58  
59  
60

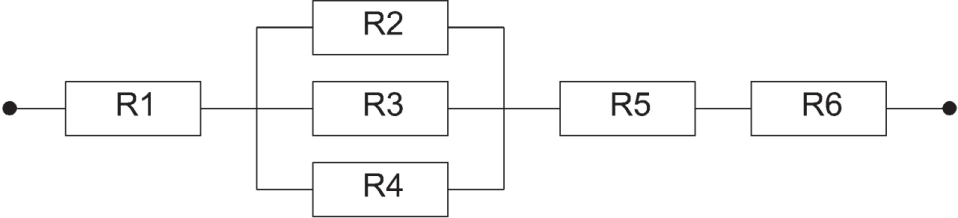


Fig.1. Conceptual Sketch of RBD

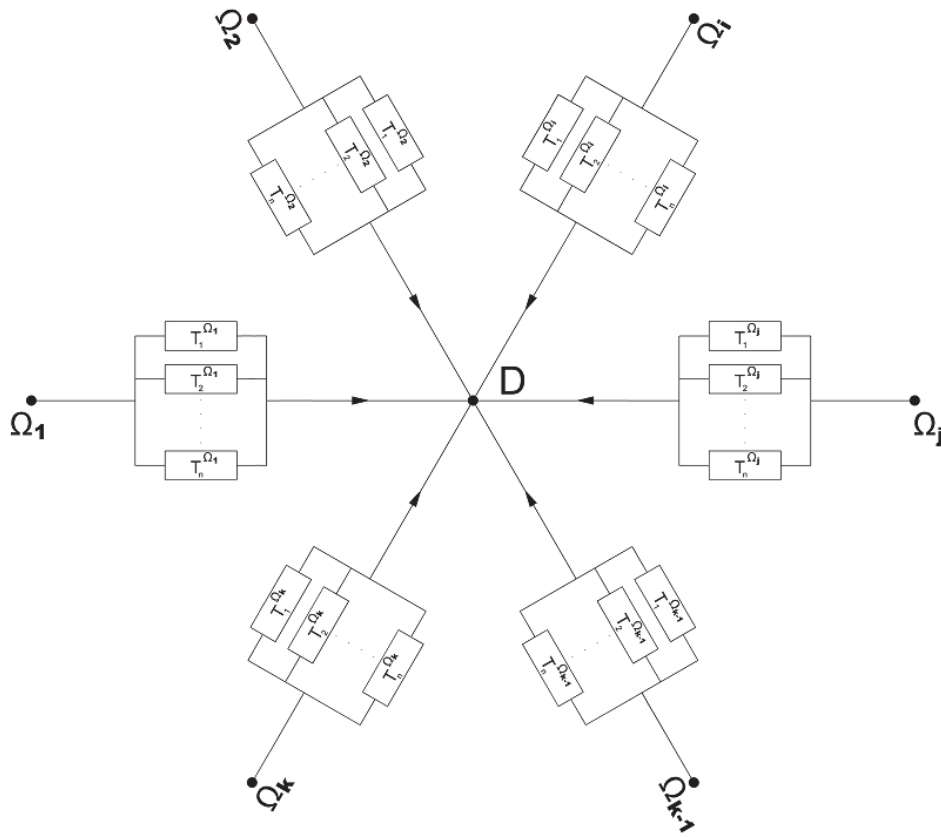


Fig.2. The modified RBD



1  
2  
3  
4  
5  
6  
7  
8  
9  
10  
11  
12  
13  
14  
15  
16  
17  
18  
19  
20  
21  
22  
23  
24  
25  
26  
27  
28  
29  
30  
31  
32  
33  
34  
35  
36  
37  
38  
39  
40  
41  
42  
43  
44  
45  
46  
47  
48  
49  
50  
51  
52  
53  
54  
55  
56  
57  
58  
59  
60

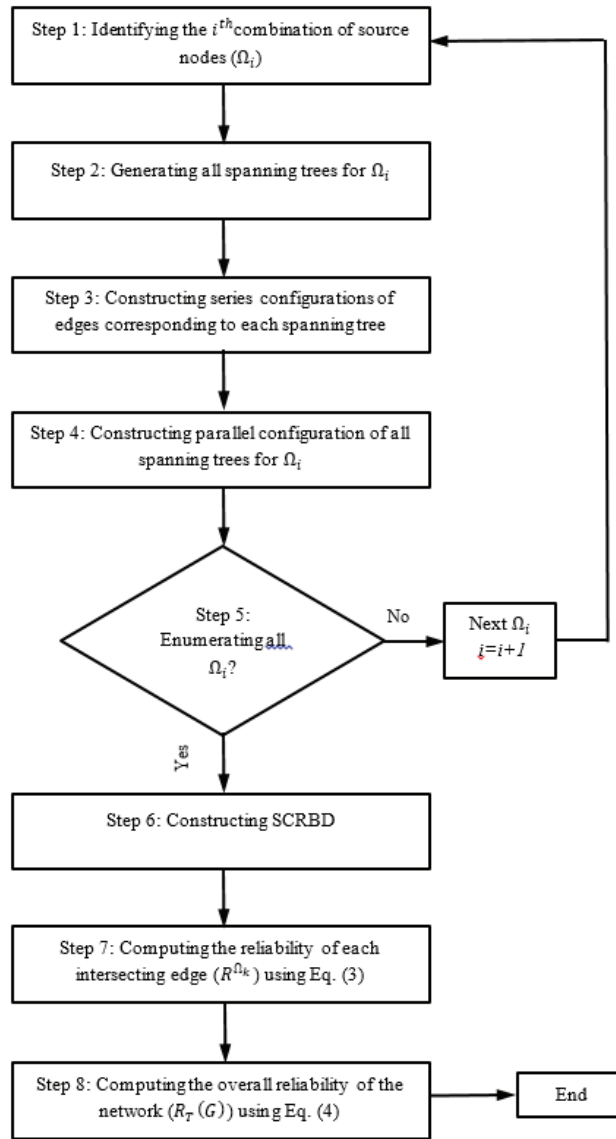


Fig.3. Flowchart for the proposed method

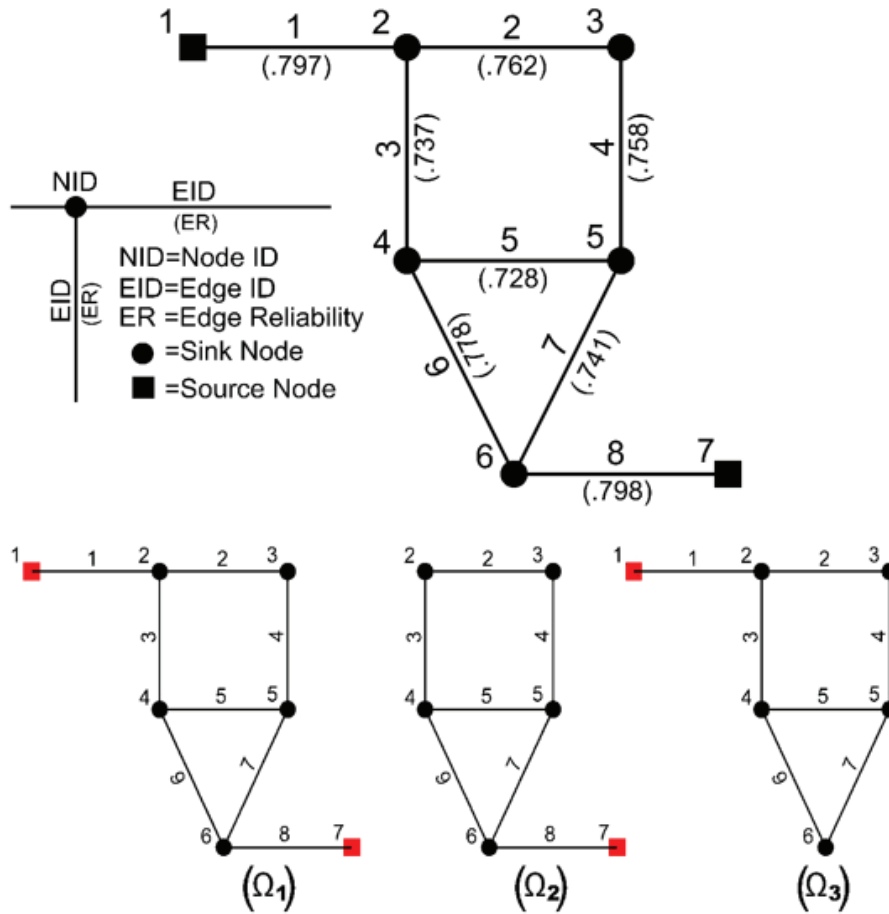


Fig.4. The layout of the illustrative example and the network events  
 $\Omega_1$ : Both source nodes are functioning  
 $\Omega_2 \& \Omega_3$ : Either of source nodes is functioning

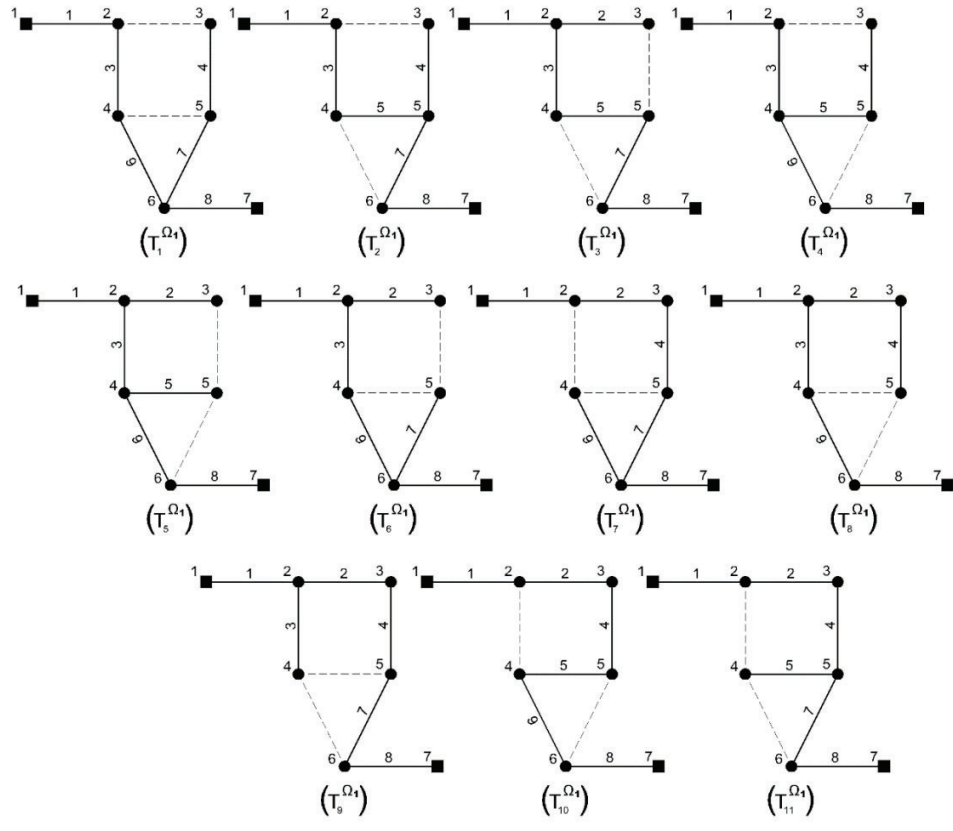


Fig.5. All spanning trees of event  $\Omega_1$

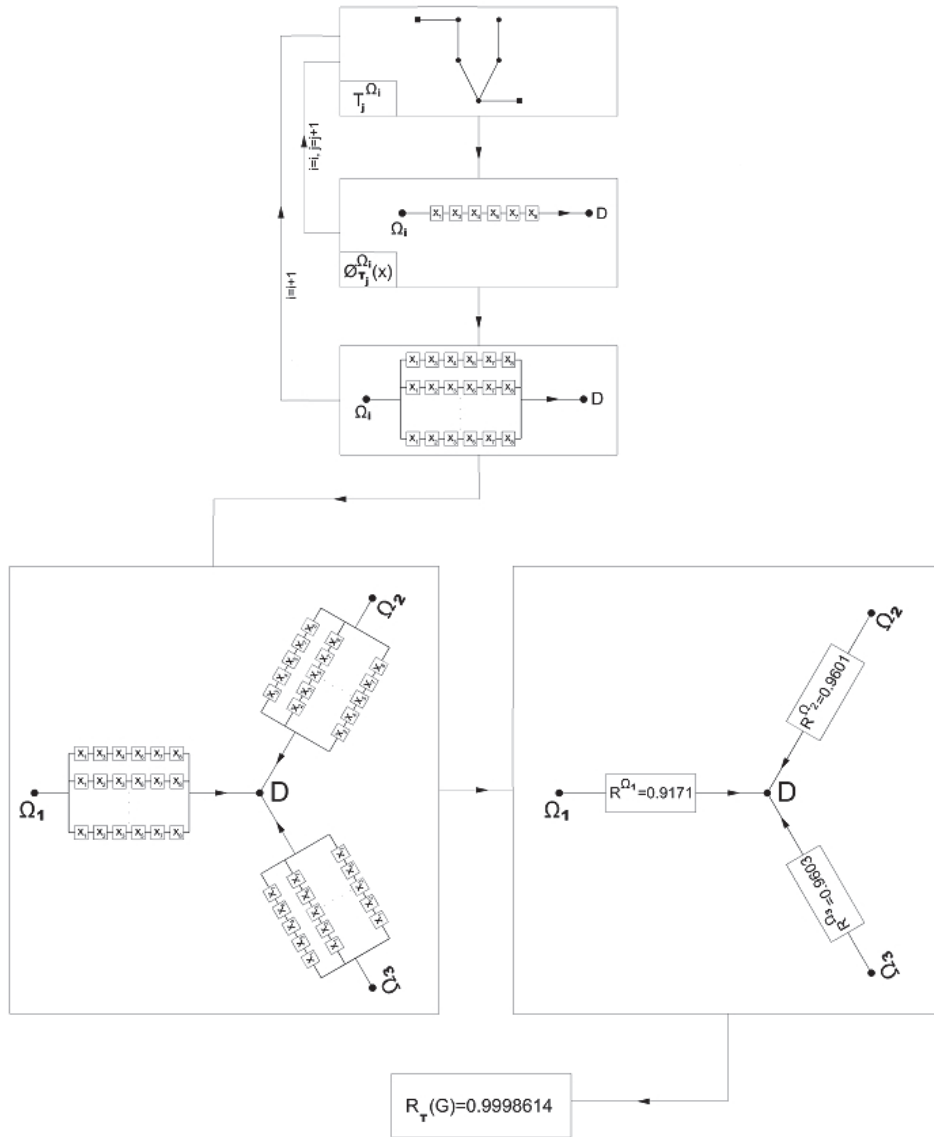


Fig.6. Overview of the proposed method demonstrated on the illustrative example

1  
2  
3  
4  
5  
6  
7  
8  
9  
10  
11  
12  
13  
14  
15  
16  
17  
18  
19  
20  
21  
22  
23  
24  
25  
26  
27  
28  
29  
30  
31  
32  
33  
34  
35  
36  
37  
38  
39  
40  
41  
42  
43  
44  
45  
46  
47  
48  
49  
50  
51  
52  
53  
54  
55  
56  
57  
58  
59  
60

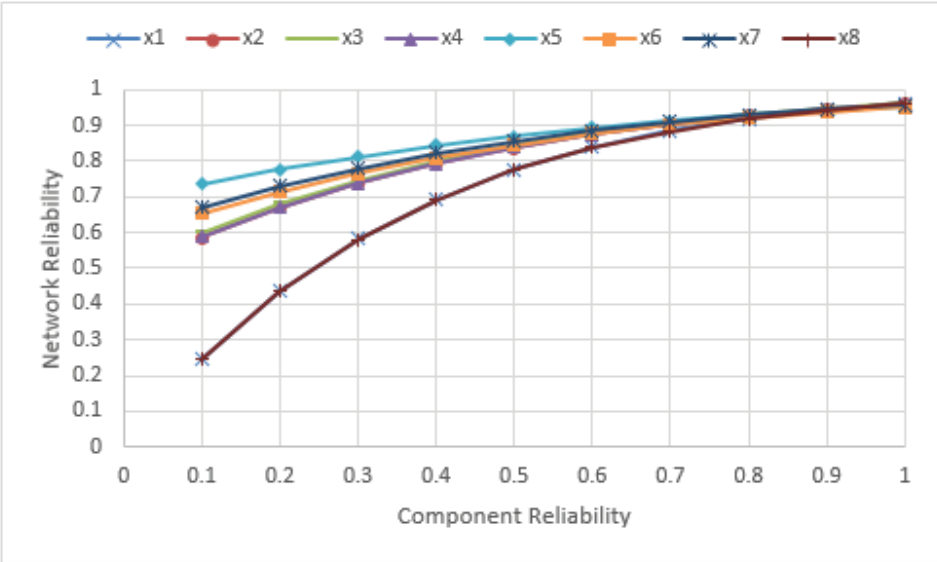


Fig.7. Network reliability vs. component reliability

## 4.2. Paper 4: Integrating entropy theory and cospanning tree technique for redundancy analysis of water distribution networks

### Statement of Authorship

Title of Paper	Integrating entropy theory and cospanning tree technique for redundancy analysis of water distribution networks
Publication Status	<input checked="" type="checkbox"/> Published <input type="checkbox"/> Accepted for Publication <input type="checkbox"/> Submitted for Publication <input type="checkbox"/> Unpublished and Unsubmitted work written in manuscript style
Publication Details	Zarghami S.A., Gunawan, I., & Schultmann, F. (2018). Integrating entropy theory and cospanning tree technique for redundancy analysis of water distribution networks. <i>Reliability Engineering and System Safety</i> . 176(2018):102-112.

### Principal Author

Name of Principal Author (Candidate)	Seyed Ashkan Zarghami
Contribution to the Paper	Design the model and computational framework- Developing the theory- Proposing a new method- Performing the analytic calculations- Demonstrating the proposed method on case studies-Discussion of results- Identifying avenues for future work- Writing the manuscript
Overall percentage (%)	85%
Certification:	This paper reports on original research I conducted during the period of my Higher Degree by Research candidature and is not subject to any obligations or contractual agreements with a third party that would constrain its inclusion in this thesis. I am the primary author of this paper.
Signature	Date 19/04/2018

### Co-Author Contributions

By signing the Statement of Authorship, each author certifies that:

- i. the candidate's stated contribution to the publication is accurate (as detailed above);
- ii. permission is granted for the candidate to include the publication in the thesis; and
- iii. the sum of all co-author contributions is equal to 100% less the candidate's stated contribution.

Name of Co-Author	Associate Professor Indra Gunawan
Contribution to the Paper	Supervising development of the work- Verifying the numerical results- Evaluation of the manuscript- Helping to edit the manuscript-Final approval of the version to be published
Signature	Date 19/4/2018

Name of Co-Author	Professor Frank Schultmann
Contribution to the Paper	Supervising development of the work –Helping to edit the manuscript- Final approval of the version to be published
Signature	Date 07/06/2018

Please cut and paste additional co-author panels here as required.



# Integrating entropy theory and cospanning tree technique for redundancy analysis of water distribution networks

Seyed Ashkan Zarghami\*, Indra Gunawan, Frank Schultmann

Entrepreneurship, Commercialisation & Innovation Center (ECIC), The University of Adelaide, Adelaide, Australia

## ARTICLE INFO

### Keywords:

Cospanning edge betweenness  
Cospanning tree  
Informational entropy  
Redundancy  
Water distribution networks

## ABSTRACT

A large number of recent studies have addressed the redundancy evaluation of Water Distribution Networks (WDNs) from a hydraulic perspective. There already exist a few topological redundancy metrics, which address very basic structural characterizations of networks and therefore fail to realistically capture the inherent topological redundancy. To remedy this weakness, we introduce, for the first time, a two-tiered approach to evaluate the redundancy of WDNs. Tier one is supported by the cospanning tree technique which offers a novel method to measure the local redundancy of pipes. Tier two uses the results of the level one and posits the informational entropy theory as a tool to measure the global redundancy of networks. An attempt has been made to generate a new robustness index as a measure to quantify the redundancy. The proposed redundancy index can be interpreted as a measure of distance from the maximum possible redundancy. In order to demonstrate the proposed method, the paper presents two case studies, a hypothetical network and a real world WDN of an Australian town. Comparison of the presented method with conventional redundancy measures reveals the superiority of the proposed redundancy method.

## 1. Introduction

Water Distribution Networks (WDNs) are the backbone of our society, which provide the critical service of conveying water to meet consumer's demands. This cannot be achieved without the continuity of functioning of these networks. The concept of redundancy is central for ensuring the continual supply of water in WDNs. There exist several definitions of redundancy in the literature. The reader is referred to Gunawan et al. [14] and the references therein. The foremost definitions are: 1) The existence of an alternative independent path between source and sink nodes through which the water can be conveyed while the main path is failed [32]; 2) Overall performance of WDNs under partial system failures [22]. In this work, we address the question of the network redundancy based on the first definition by taking into account the number of simultaneous pipes failure that a WDN can sustain without affecting partial or overall performance of the system [17]. Although the layout of the valves in WDNs is equally important as the network topology [3,8,15], we simplify the concept of redundancy by mapping a network into a graph consisting of a set of vertices and edges representing demand nodes and pipes, respectively.

Researchers are recognizing that the redundancy evaluation of WDNs is of great importance for ensuring continual supply of water. Redundancy can be evaluated along with system reliability [33] and most

studies in the reliability optimization employ redundancy strategies for improving the reliability [1,24,25]. The methods for quantifying the redundancy, developed in the last three decades, are mainly based on the principle that the existence of alternative paths from source to demand nodes provides reliability in WDNs [2,23]. In recent years, analyzing of an explicit level of redundancy instead of incorporation of implicit reliability constraints has become a primer approach to evaluate the reliability of WDNs [34].

Two rather different approaches have been proposed in the literature to evaluate the redundancy of WDNs: the topological approach and the hydraulic approach. Topological approach refers to the availability of a continuous physical path from a source to each demand nodes in the event of pipe failure. Hydraulic approach addresses the supply of required quantity of water under adequate pressure [18].

Most existing literature studies the reserve capacity of WDNs from a hydraulic point of view. Goulter [13] used a linear programming-gradient method for optimization of WDNs through the study of the redundancy in a looped WDN to maintain the minimum pressure at each node of the network. Gupta and Bhawe [16] conducted a node-flow analysis in order to perform the availability analysis of water at different nodes during deficient conditions. Todini [39] proposed a new resilience index based on the notion of energetic redundancy. Prasad and

\* Corresponding author.

E-mail addresses: [ashkan.zarghami@adelaide.edu.au](mailto:ashkan.zarghami@adelaide.edu.au) (S.A. Zarghami), [indra.gunawan@adelaide.edu.au](mailto:indra.gunawan@adelaide.edu.au) (I. Gunawan), [frank.schultmann@adelaide.edu.au](mailto:frank.schultmann@adelaide.edu.au) (F. Schultmann).

<https://doi.org/10.1016/j.ress.2018.04.003>

Received 29 September 2017; Received in revised form 16 March 2018; Accepted 9 April 2018

Available online 12 April 2018

0951-8320/© 2018 Elsevier Ltd. All rights reserved.

**Table 1**  
Topological metrics used to quantify the redundancy of WDNs.

Metric	Mathematical expression	Parameters
Edge density	$E_d = \frac{2m}{n(n-1)}$	$m$ : Number of edges $n$ : Number of nodes
Clustering coefficient	$CC_T = \frac{1}{n} \sum \frac{2t_i}{k_i(k_i-1)}$	$n$ : Number of nodes $k_i$ : Degree of node $i$ $t_i$ : Number of triangles attached to node $i$
Meshedness coefficient	$r_m = \frac{m-n+1}{2n-5}$	$m$ : Number of edges $n$ : Number of nodes

Park [28] modified Todini's index by reflecting the relative size of pipes meeting at a demand nodes. They also explored the effect of various level of hydraulic redundancy and surplus power on WDNs. Di Nardo and Di Natale [10] adopted Todini's index to measure the redundancy of water systems due to water district metering. Wright et al. [42] evaluated the resilience of WDNs to failure by assessing the hydraulic redundancy in the case of disruptive events. Tanyimboh et al. [36] investigated the effectiveness of four surrogate measures for the hydraulic reliability and redundancy of WDNs, namely, resilience index, network resilience, statistical flow entropy and surplus power factor.

The redundancy research just cited approaches the redundancy problem from a hydraulic perspective, with little recourse to graph theory, which might help to capture the redundancy inherent within the layout of WDNs. Wagner et al. [40] measured the connectivity and reachability of WDNs in order to identify the systems with serious problems due to insufficient redundancy. Mays and Cullinane [26] reviewed the application of fault tree analysis, state enumeration, cut set and path enumeration methods in reliability evaluation of WDNs. These methods are useful for redundancy and reliability analysis of series, parallel and series-parallel networks. However, WDNs are mainly structured in a complex manner and are not necessarily those of with series, parallel or series-parallel configurations. These approaches are therefore not directly applicable to lopped systems unless they are applied in oversimplified fashion [13].

More recently the three most commonly used topological redundancy metrics (Table 1), namely, *Edge density*, *Clustering coefficient*, and *Meshedness coefficient*, have been used for topological redundancy analysis of WDNs. These metrics explore the redundancy of WDNs through determining the sparseness, dense-connectivity of a network layout, or density of triangles and loops in a network [43].

*Edge density* is a measure of overall sparseness of the network and can be stated as the ratio of the actual number of edges and the maximal number of possible edges.

*Clustering coefficient* is a measure of the density of triangles in a network [9]. That is, how likely two nodes that are connected, are part of a larger connected group of nodes [27].

*Meshedness coefficient* captures the status of loops in a network by quantifying the density of loops, which is defined as the ratio of the actual and possible number of loops [5].

As discussed earlier, a few authors have quantified the structural redundancy of WDNs by employing the abovementioned metrics. Yazdani and Jeffrey [[43] and [44]] measured the redundancy of four benchmark real distribution networks by employing these metrics. In a similar vein, Yazdani et al. [45] adopted these metrics to quantify the redundancy of WDN of a growing city in order to explore network expansion strategies. Di Nardo et al. [11] engaged a topological performance index measured by *Meshedness coefficient* to estimate the topological redundancy of two real WDNs. Di Nardo et al. [12] computed the redundancy topological metrics for six WDNs. The authors compared the topological metrics with the energy-based redundancy metrics and discussed the correlation and deviation between them.

The metrics discussed above capture very generic topological properties of networks such as density of edges, number of loops and trian-

gles as an indicator of the network redundancy. They show how well nodes are linked together and give a general overview of the overall redundancy of the network. However, off these metrics *Edge density* and *Meshedness coefficient* address very basic topological characterizations of a network (number of nodes and edges) and ignore key redundancy features inherent within the layout of WDNs. Additionally, these metrics do not indicate the redundancy at specific location but rather the redundancy of the network as a whole. Moreover, the global *Clustering coefficient* characterizes the overall network redundancy based on loops of order three, whereas the real-world WDNs mainly consist of higher order loops. These metrics are somewhat unrealistic to evaluate the redundancy of WDNs, since they ignore the valuable characteristics of the networks redundancy that can be inferred through their topological properties.

Table 2 outlines the strengths and weaknesses of the abovementioned redundancy indices.

In order to contribute to overcoming these shortcomings, we introduce, for the first time, a two-tiered approach to evaluate the redundancy of WDNs. Tier one is supported by cospanning tree technique and offers a novel approach to measure the local redundancy of pipes. Tier two uses the results of the level one and posits the informational entropy theory as a tool to measure the global redundancy of the network.

The proposed approach evaluates the redundancy of WDNs from a topological point of view using the network theory, which allows intuitive representations and detailed systemic topology descriptions of WDNs [19]. We adopt cospanning tree technique as a graph theory tool in order to establish a new metric, termed *Cospanning Edge Betweenness*, which signifies the local importance of pipes from the redundancy point of view. This work also explores the potential of informational entropy to evaluate the global redundancy of WDNs. To this end, we demonstrate how uncertainty of variables and diversity in choices, obtained as a result of informational entropy, can be interpreted in terms of the network redundancy.

The structure of the remainder of the paper is as follows: Section 2 develops the proposed redundancy index by integrating the informational entropy and cospanning tree technique. Basic definitions, as a basis for developing the proposed method as well as an overview on the entropy theory are also described in this section. Section 3 presents two case studies as illustrations of the proposed redundancy analysis method followed by investigations of the results and comparison of the presented index and the conventional redundancy metrics. Section 4 outlines conclusions and discussion about possible avenues for future work.

#### Notation

The following symbols are used in this paper:

$CB(e)$  = Cospanning edge betweenness of an edge;

$CC_T$  = Clustering coefficient;

$CEB$  = Cospanning edge betweenness;

$\delta_G(e)$  = Spanning edge betweenness;

$E$  = A set of edges in a graph;

$e_i$  = An edge of a graph;

$e_{i,j}$  = An edge of a graph between node  $i$  and  $j$ ;

$E_d$  = Edge density;

$G$  = A graph,

$H$  = Entropy of distribution;

$H_{CB}$  = Entropy of a set of cospanning edges;

$H_{CBmax}$  = Maximum entropy of a set of cospanning edges;

$m$  = Number of edges in the network;

$n$  = Number of nodes in the network;

$n_{T^*}$  = Total number of the cospanning trees of a graph;

$n_{T^*}(e)$  = Number of outcomes that an edge is part of cospanning trees;

$P$  = A set of probabilities;

$q$  = Cardinality of a set;

$r_m$  = Meshedness coefficient;

$R_{CB}$  = Entropy-based cospanning redundancy index;

$T$  = A spanning tree of a graph;



$T^*$  = A cospanning tree of a graph;  
 $\tau_G$  = Number of minimum spanning trees of a graph;  
 $\tau_G(e)$  = Number of minimum spanning trees in which the edge  $e$  occurs;  
 $V$  = A set of vertices in a graph;  
 WDNs = Water distribution networks;

## 2. Methods

### 2.1. Preliminary definitions

Before starting the main discussion, we define some terminologies which will be used throughout this paper. These terminologies are more graph theory related and we explain just the collection of definitions, which provide the basis for developing the proposed method in this research.

**Undirected Graph:** An undirected graph  $G = (V, E)$  consists of a nonempty set of vertices and a set of unordered pairs of distinct edges. Each edge is identified with a pair of vertices.

**Cut edge:** A cut edge (bridge) is an edge of the graph whose removal creates more sub-systems than previously in the graph. A cut edge contributes to the system vulnerability and is seen as a critical component because it is essential for the system function [21].

**Spanning tree:** Spanning tree is a tree shape subgraph that contains every vertex of the original graph that ensures connectedness. A spanning tree can be generated through a recursive procedure by choosing a cycle in a connected graph and removing any one of its edge such that the resulting graph is still connected and until no cycles are left [41]. The links of a spanning a tree are called spanning edge.

**Cospanning tree:** If  $T = (V, E')$  is a spanning tree of graph,  $G = (V, E)$ , then  $T^* = (V, E - E')$  is a cospanning tree of  $G$ . In this paper, we use the term cospanning edge for each link of a cospanning tree.

**Cardinality:** Cardinality of a set is the number of elements of the set. For example the cardinality of edges set in a cospanning tree is  $q = m - n + 1$ , where  $n$  and  $m$  are the number of nodes and edges, respectively.

Fig. 1 depicts a WDN with 10 nodes ( $N_i$ ) and 13 edges ( $e_i$ ) in which the set of spanning edges,  $T$ , is indicated by solid lines and the set of cospanning edges,  $T^*$ , is illustrated by dashed lines.

### 2.2. Cospanning edge betweenness

Many researchers have used the centrality measures to analyse the real-world complex networks. Centrality measures highlight the importance of a network element (node or edge) pertaining to a given network performance. Such a capability has become recognized as increasingly beneficial and important in evaluating the role that presence and location of an element plays with respect to the average global and local properties of the whole network [6]. Based on the concept of an edge importance in a network, recently, Teixeira et al. [37] proposed a new edge betweenness centrality metrics so-called spanning edge betweenness, by calculating the fraction of minimum spanning trees that contain an edge  $e$ . This metric can be formulated as follows:

$$\delta_G(e) = \frac{\tau_G(e)}{\tau_G} \quad (1)$$

**Table 2**

Overview of strengths and weaknesses of the existing redundancy metrics.

Metric	Local/Global	Strengths	Weaknesses
$E_d$	Global	Measuring overall sparseness Easy to calculate	No discrimination between different networks with the same number of edges and nodes
$CC_T$	Local Global	Measuring density of triangles	Not suitable for networks containing non triangular cycles
$r_m$	Global	Measuring overall status of loops Easy to calculate	No discrimination between different networks with the same number of edges and nodes

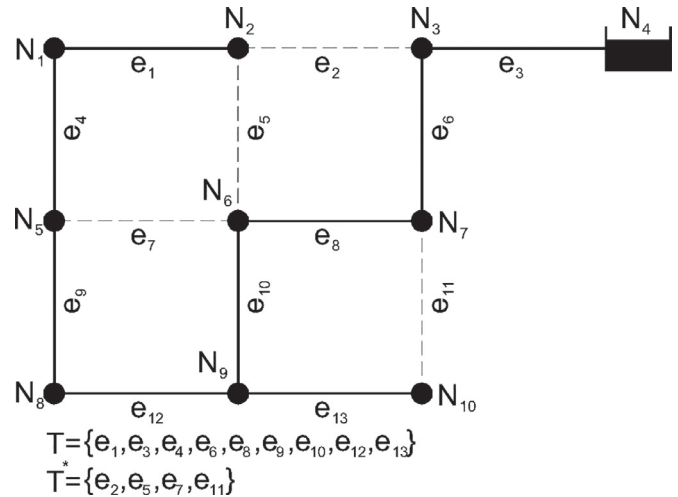


Fig. 1. An example of a spanning tree,  $T$ , and a cospanning tree,  $T^*$ , in a WDN.

where  $\delta_G(e)$  denotes spanning edge betweenness,  $\tau_G(e)$  is the number of minimum spanning trees in which the edge  $e$  occurs, and  $\tau_G$  is the number of minimum spanning trees of the graph  $G$ .

Spanning edge betweenness is an edge-based statistical centrality measures to identify the local importance of each edge. Though this metric originally was proposed to develop the phylogeny algorithms, later on it found its way to evaluate the redundancy of network [38]. Spanning edge betweenness relies on the edges of the minimum spanning trees of an unweighted graph. Qi et al. [29] extended it to all spanning trees of weighted graphs by proposing a node-based centrality measure, called spanning tree centrality.

In order to provide a more intuitive insight into the spanning edge betweenness and improve its fit with WDNs features, we here introduce a refined centrality metric, termed *Cospanning Edge Betweenness*.

In Eq. (1), redundancy is inversely proportional to  $\delta_G(e)$ , which means  $\delta_G(e)$  is greater if the edge redundancy is smaller. Following the philosophy of cospanning tree, we refine the Eq. (1) by calculating the probability of an edge being part of a cospanning tree instead of a spanning tree. The resulting metric will be directly proportional to an edge redundancy, which gives more meaningful and intuitive indication of the redundancy concept. Moreover, the exclusion of non-redundant pipes (i.e. cut edges) in the formula, by taking on the value of 0, decreases the computational efforts.

Given an undirected and connected graph  $G = (V, E)$ , we define the *Cospanning Edge Betweenness (CEB)* of an edge  $e$ , as the probability that this edge is a cospanning edge. This definition can be expressed in a mathematical expression as given below:

$$CB(e) = \frac{n_{T^*}(e)}{qn_{T^*}} \quad (2)$$

where  $CB(e)$  is *Cospanning Edge Betweenness* of edge  $e$ ,  $n_{T^*}(e)$  is the number of outcomes that this edge is part of cospanning trees,  $n_{T^*}$  represents the total number of the cospanning trees of  $G$ ,  $q$  is the cardinality of the edges set in a cospanning tree, and  $qn_{T^*}$  denotes the total number of cospanning edges.

By definition  $0 \leq CB(e) < 1$ . It should be noted that  $CB(e)$  can't take on the value of 1 since for an accurate representation of WDNs, we assume that a graph  $G$  is a connected graph.  $CEB$  exhibits the following basic properties:

- (1) The lower extreme value,  $CB(e) = 0$ , represents a cut edge of a graph  $G$  whose removal disconnects the network.
- (2) The upper extreme, whereby  $CB(e)$  approaches 1, reflects the highest possible redundant edge whose removal rarely causes disruption in the network.
- (3) When  $0 < CB(e) < 1$ , there exist alternative paths that provide the connectivity of the network. The edges with higher values of  $CEB$  demonstrate higher redundancy than those of with lower values.

$CEB$  has been proposed based on two ideas: 1) a network with more cospanning trees is more redundant, 2) the edges located on many cospanning trees, are of more importance than those of with less participations in cospanning trees. As we will see in Section 4,  $CEB$  successfully identifies the weaknesses in a network and provides a numerical indicator to evaluate the importance of edges from the redundancy point of view. However, the stand-alone use of this metric yields insufficient information to evaluate the overall redundancy of the network. The solution to this problem is provided in Section 2.4 by proposing an entropy-based redundancy index, which can be utilized as a measure of potential contribution of an edge to overall redundancy of the network. First, we will recall the notion of informational entropy in the following subsection.

### 2.3. Informational entropy

The concept of informational entropy was introduced by Shannon [31] as a measure of information, choice and uncertainty. Shannon entropy can be expressed for the set of probabilities  $P = \{p_i : i = 1, 2, \dots, n\}$  as:

$$H = - \sum_{i=1}^n p_i \log_b p_i \quad (3)$$

where  $H$  is the entropy of distribution,  $n$  is the number of possible outcomes and  $b$  is an arbitrary logarithm base by which the unit of entropy is defined, for example bits for  $b=2$ , Napier for  $b=e$  and decibels for  $b=10$ .

Entropy has found application in a wide range of fields since its inception. In the redundancy context, researchers have developed a number of innovative ways to use the entropy theory to evaluate the redundancy of networks. The work of Awumah et al. [4] was one of the first studies that attempted to employ the informational entropy to measure the redundancy of WDNs. Drawing on the information entropy, Hoshiya and Yamamoto [20] proposed a redundancy index to measure the reserve capacity of lifeline systems. Ziha [47,48] incorporated the entropy concept into an event-oriented system analysis in order to assess the redundancy of engineering systems. Singh and Oh [32] developed a Tsallis entropy-based redundancy measure for WDNs and incorporated path dependency and age factors into the method. Tanyimboh [35] proposed a multi-objective genetic algorithm supported by the informational entropy to evaluate the reliability and failure tolerance of WDNs. The following section demonstrates how uncertainty and choice of variables, obtained from the informational entropy can be leveraged to quantify the overall redundancy of WDNs.

### 2.4. Entropy-based cospanning edge redundancy index

Up to this point, we have measured the local redundancy of an edge based on its participation in a cospanning tree. In this section, each edge in a network is associated with a cospanning edge betweenness and a new approach to analyse the overall redundancy of a WDN drawing

on the local redundancy of each pipe is proposed. In this sense, we explore the potential of informational entropy, as a method to evaluate the global redundancy of WDNs.

The network redundancy not only depends upon the probability that an edge is part of a cospanning tree, but also upon the number of cospanning edges. Cospanning edges are conditionally reliant on each other. That is, if some cospanning edges occur with substantially higher probability than the others do, then the likelihoods of participating of other edges in a cospanning tree plummet. It is more advantageous from the redundancy point of view for having more edges being part of cospanning trees, which intuitively reflects the multiplicity of alternative paths in the network. This is precisely how the informational entropy behaves. The intuitive principle behind the desirability of having a set of uniformed cospanning edges is very reminiscent of the principle of the maximum entropy by selecting a distribution, which offers the largest remaining uncertainties and choices. In other words, the greater the uniformity of edges in terms of participating in cospanning trees, the greater the entropy.

In this work, the problem of evaluating the global redundancy of WDNs is solved by means of the Shannon entropy, introduced in the previous section. To illustrate, let  $\{e_i | i = 1, 2, \dots, m\}$  be a set of edges in a network and let  $q$  be the cardinality of the edges set of each cospanning tree. Furthermore, let  $CB(e_i)$  be the corresponding  $CEB$  of each edge. We then define the entropy of the set of cospanning edges,  $H_{CB}$  as:

$$H_{CB} = - \sum_{i=1}^m CB(e_i) \log_2 CB(e_i) \quad (4)$$

For a network with  $m$  edges and  $n_{T^*}$  cospanning trees with the cardinality of  $q$ ,  $H_{CB}$  is maximum and equal to  $\log_2 m$  when all  $CB(e_i)$  are equal, i.e.,  $CB(e_i) = \frac{1}{m}$ . This is because:

$$\sum_{i=1}^m n_{T^*}(e_i) = qn_{T^*} \quad (5)$$

The Eq. (5) can be written as:

$$\sum_{i=1}^m CB(e_i) = 1 \quad (6)$$

Since we assume  $CB(e_1) = CB(e_2) = \dots = CB(e_m)$ , therefore:

$$CB(e_i) = \frac{1}{m}, i = 1, 2, \dots, m \quad (7)$$

By substituting the Eq. (7) into the Eq. (4):

$$H_{CBmax} = \log_2 m \quad (8)$$

Heuristically,  $H_{CBmax}$  denotes the situation with the most possible choices, in which all edges participate in cospanning trees. We define the redundancy index  $R_{CB}$ , as the fractional differences between the entropy of a set of  $CEBs$  and its maximum possible value. This can be expressed by the following equation:

$$R_{CB} = \frac{- \sum_{i=1}^m CB(e_i) \log_2 CB(e_i)}{\log_2 m} \quad (9)$$

where the numerator is the entropy of the set of cospanning edges betweenness, and the denominator is introduced as a normalization factor such that  $R_{CB} \in [0,1]$ .

The redundancy index proposed here resembles the redundancy definition by satisfying the following properties:

- (1) If  $R_{CB}$  is closer to 1, the redundancy is higher, and otherwise smaller.
- (2)  $R_{CB}$  attains its maximum value ( $R_{CB} = 1$ ), when  $\{CB(e_i) | i = 1, 2, \dots, m\}$  is uniformly distributed. This case corresponds to the situation with most possible choices since there exist many alternative paths.
- (3)  $R_{CB}$  attains its minimum value ( $R_{CB} = 0$ ), when the network has a unique spanning tree without any cospanning tree, which implies the network is a tree.

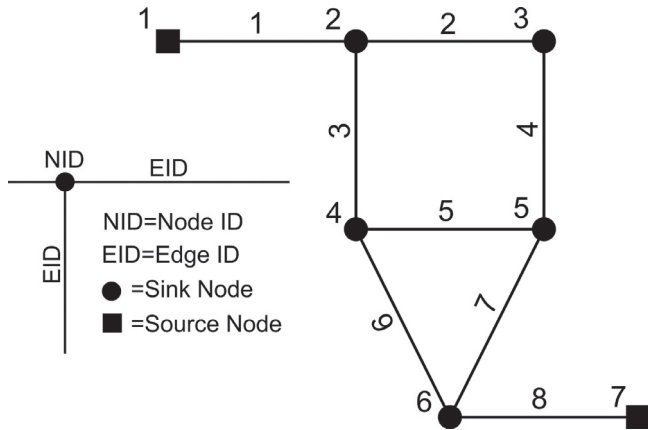


Fig. 2. Case study1: A hypothetical water distribution network.

### 3. Case studies

In order to illustrate the proposed method, this section presents two case studies, a hypothetical network and a real world WDN of an Australian town.

#### 3.1. Case study 1

The first case study is a hypothetical network (Fig. 2) consists of eight pipes, two source nodes (tanks) and five sink nodes (consumers).

Although of limited size, the network is representative and provides step by step elaborated structures of the proposed method

In this section, we first implement the proposed method by computing the value of  $CEB$  for each individual pipe, followed by calculating the global redundancy through the use of Eq. (9), thereafter we investigate the effectiveness of the proposed index by performing a comparative analysis.

As a means to illustrate the use of the proposed redundancy analysis, first, this case study has been mapped into an undirected graph with a node set of size 7 and an edge set of size 8. SageMath 6.10 an open source mathematical software system has been employed to generate all spanning/cospanning trees of the network. Fig. 3 illustrates all spanning/cospanning trees of the network. Solid lines indicate the spanning edges, whereas dashed lines plot the cospanning edges.

Using the proposed methodology, different parameters for the example network have been calculated. These parameters are summarized in Table 3.

The results obtained from Table 3 intuitively resemble the redundancy attributes of the network, which can be worded as follows:

As it can be observed in Fig. 2, pipes 1 and 8 are cut edges, whose removal will disconnect parts of the network. As expected,  $CB(e_1) = CB(e_8) = 0$ , which can be attributed to the non-redundant characteristic of these pipes in the network, since there is only one pipe originates from sources 1 and 7.

Pipe 5 exhibits a higher value of redundancy than other edges. To a large extent, this can be ascribed to the central location of this pipe through which more alternative paths pass and therefore it attains a higher value of redundancy as compared to the other edges.

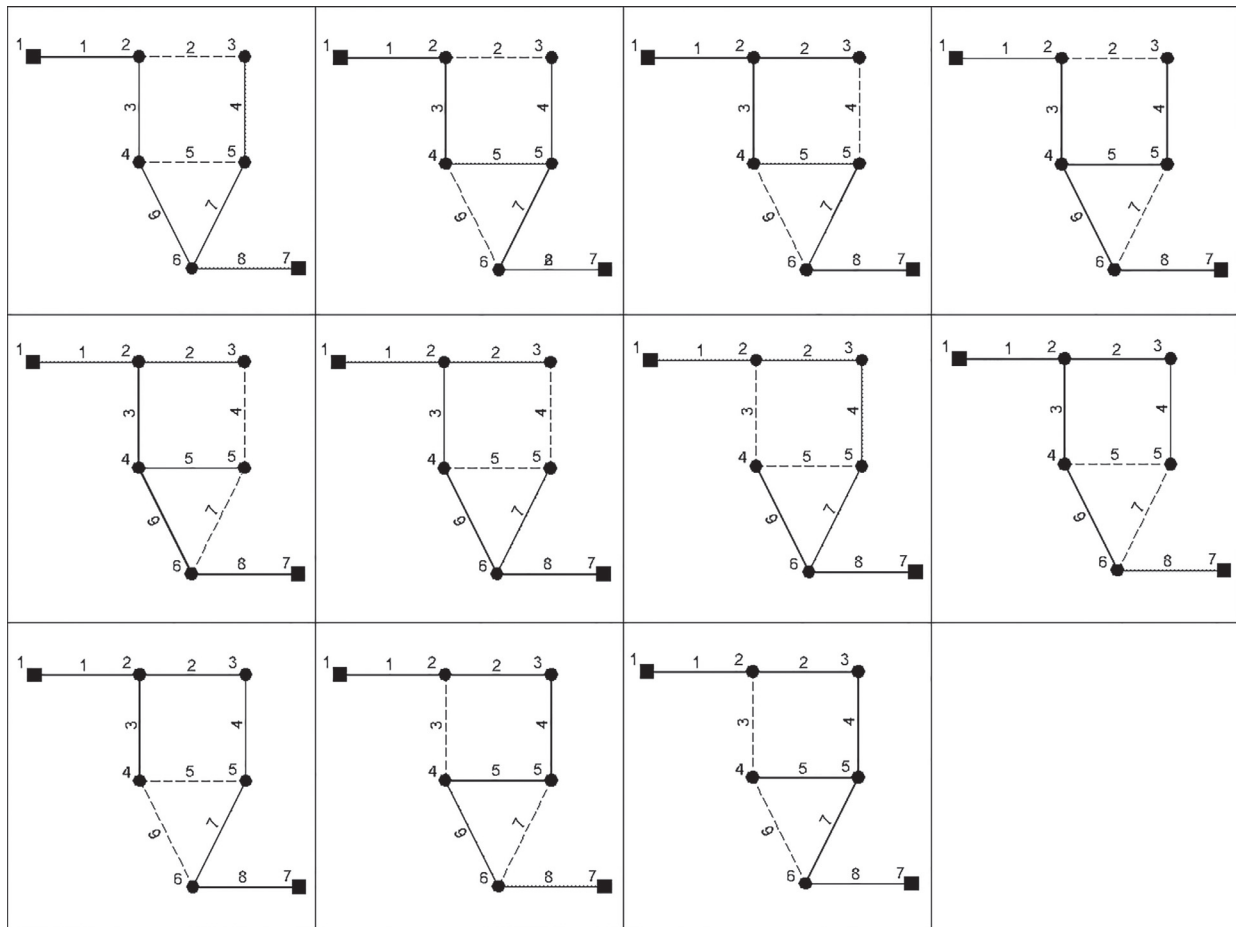


Fig. 3. All spanning/cospanning trees of the network in Fig. 2.

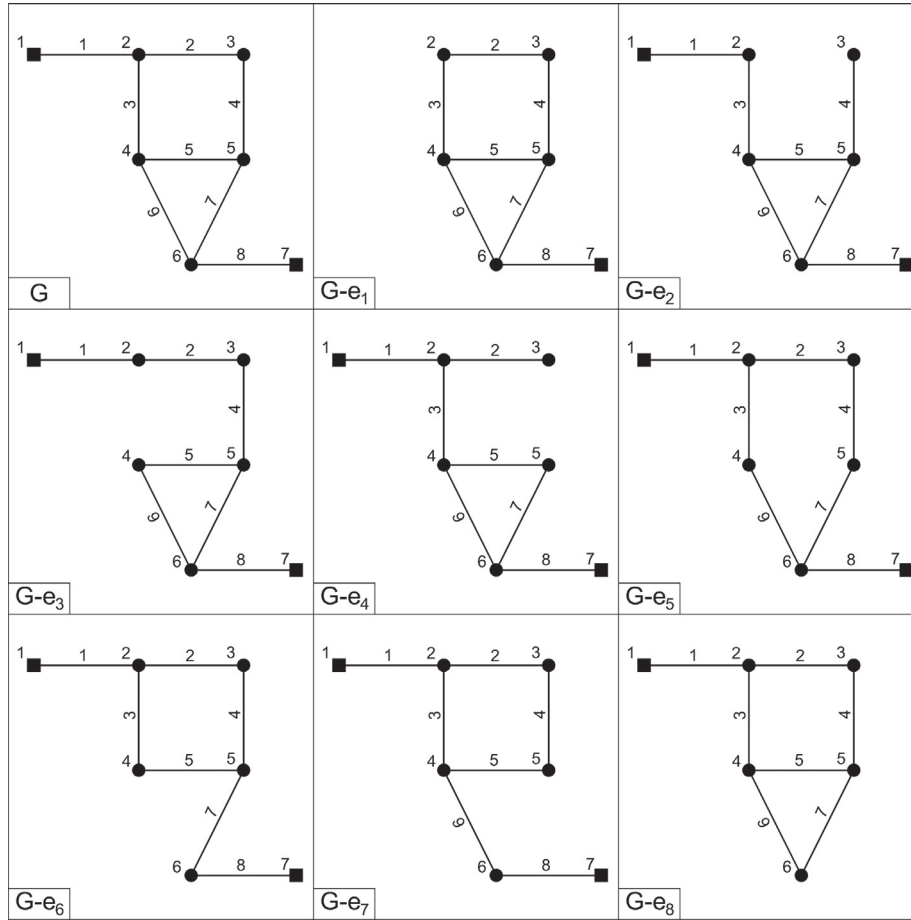


Fig. 4. Nine different layouts of the first case study.

As shown in Table 3,  $CB(e_2) = CB(e_3) = CB(e_4) = 0.1363$ , the intuitive explanation of the same value of redundancy for these pipes is that, they are placed symmetrically in a loop of order four, so that each just borders a single loop in which they are located. Thus, they all have the same tendency in providing connection to the remainder of the networks. Similarly, pipes 6 and 7 show the same trend as they are also symmetrically placed just in a loop of order three.

Up to this point, the redundancy analysis has been performed at the local level. Now it is possible to extend the analysis further to the global level by using Eq. (9). In this case study,  $m = 8$ , therefore,  $H_{CBmax} = 3$  bits. If we substitute these values as well as the results obtained from Table 3 into Eq. (9), then  $R_{CB} = 0.8520$ . This fraction can be interpreted as a measure of distance from maximum possible redundancy of the network.

We now compare the proposed redundancy index and the conventional redundancy measures in order to investigate the effectiveness of

the proposed method. The conventional measures considered are *Edge density*, *Meshedness coefficient*, and *Clustering coefficient*. These measures are compared for nine different layouts (see Fig. 4). In each layout, a pipe is removed so as to investigate its influence on the redundancy measures.

We assume  $G - e_i$  as the layout obtained from the case study by removal of pipe  $e_i$ . The numerical values of the redundancy metrics for different layouts are summarized in Table 4.

In order to provide a better visualization of the results, Fig. 5 portrays the numerical values obtained from Table 4.

Examination of Fig. 5 indicates that the *Edge density*, *Meshedness coefficient* and *Clustering coefficient* yield insufficient information for the redundancy analysis. While different layouts demonstrate different redundant behaviors,  $E_d$  and  $r_m$  for  $G - e_2, G - e_3, G - e_4, G - e_5, G - e_6$  and  $G - e_7$  remain at the same value of 0.3333 and 0.1111, respectively. Furthermore, despite the redundant characteristic of  $G - e_5, G - e_6$ , and

Table 3  
The parameters used for obtaining  $R_{CB}$  – case study 1.

$e_i$	$n_{T^*}(e_i)$	$CB(e_i)$	$CB(e_i)\log_2 CB(e_i)$
1	0	0	0
2	3	0.1363	-0.3920
3	3	0.1363	-0.3920
4	3	0.1363	-0.3920
5	5	0.2272	-0.4858
6	4	0.1818	-0.4472
7	4	0.1818	-0.4472
8	0	0	0

Table 4  
Numerical values of redundancy metrics (case study 1).

Layout	$R_{CB}$	$E_d$	$r_m$	$CC_T$
$G$	0.8520	0.3810	0.2222	0.1429
$G - e_1$	0.9105	0.4667	0.2857	0.1667
$G - e_2$	0.5646	0.3333	0.1111	0.1429
$G - e_3$	0.5646	0.3333	0.1111	0.2381
$G - e_4$	0.5646	0.3333	0.1111	0.2381
$G - e_5$	0.8271	0.3333	0.1111	0
$G - e_6$	0.7124	0.3333	0.1111	0
$G - e_7$	0.7124	0.3333	0.1111	0
$G - e_8$	0.9105	0.4667	0.2857	0.2778

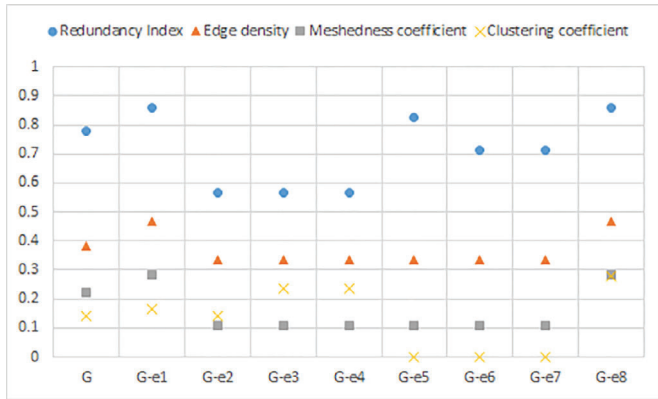


Fig. 5. Different redundancy measures for different layouts (case study 1).

$G - e_7$ ,  $CC_T$  for these layouts take on the value of zero. As noted earlier, these metric fail to realistically capture the inherent topological redundancy of a network because they just take into account the density of edges and the number of loops and triangles.

Table 4 demonstrates that  $R_{CB}$  span from 0.5646 for the layouts containing three cut edges to 0.9105 for the layouts comprising of one cut edge. Though adding an extra source node improves the hydraulic reliability of the network, the original network layout ( $G$ ) shows a lower redundancy index than the layouts  $G - e_1$  and  $G - e_8$  (as shown

in Fig. 5). This is because the proposed method addresses the question of redundancy from an exclusive topological point of view and therefore does not differentiate between source and demand nodes. From a pure topological perspective, connecting an extra node with a cut edge (without providing alternative paths) does not contribute to the network redundancy but contributes to the vulnerability of the network.

The range of  $R_{CB}$  observed in Fig. 5 reveals an inverse correlation between the number of cut edges and the redundancy values. That is, the lowest values of  $R_{CB}$  correspond to those with largest number of cut edges ( $G - e_2$ ,  $G - e_3$ ,  $G - e_4$ ). This is because a cut edge is a critical component and contributes to the system vulnerability. As a result, a lower number of cut edges leads to a higher value of the proposed redundancy index.

### 3.2. Case study 2

In order to evaluate the general and practical applicability of the proposed method, we demonstrate it on a real world WDN of Yorktown, a small town in York Peninsula, located 230 km west of Adelaide, Australia. The layout for this case study has been obtained from the official website of South Australia Water company (<http://sawater.maps.arcgis.com>; [30]). The example network is mapped into a graph with 56 nodes, representing demand nodes, and 59 edges, representing pipes varying from 80 mm to 200 mm (Fig. 6).

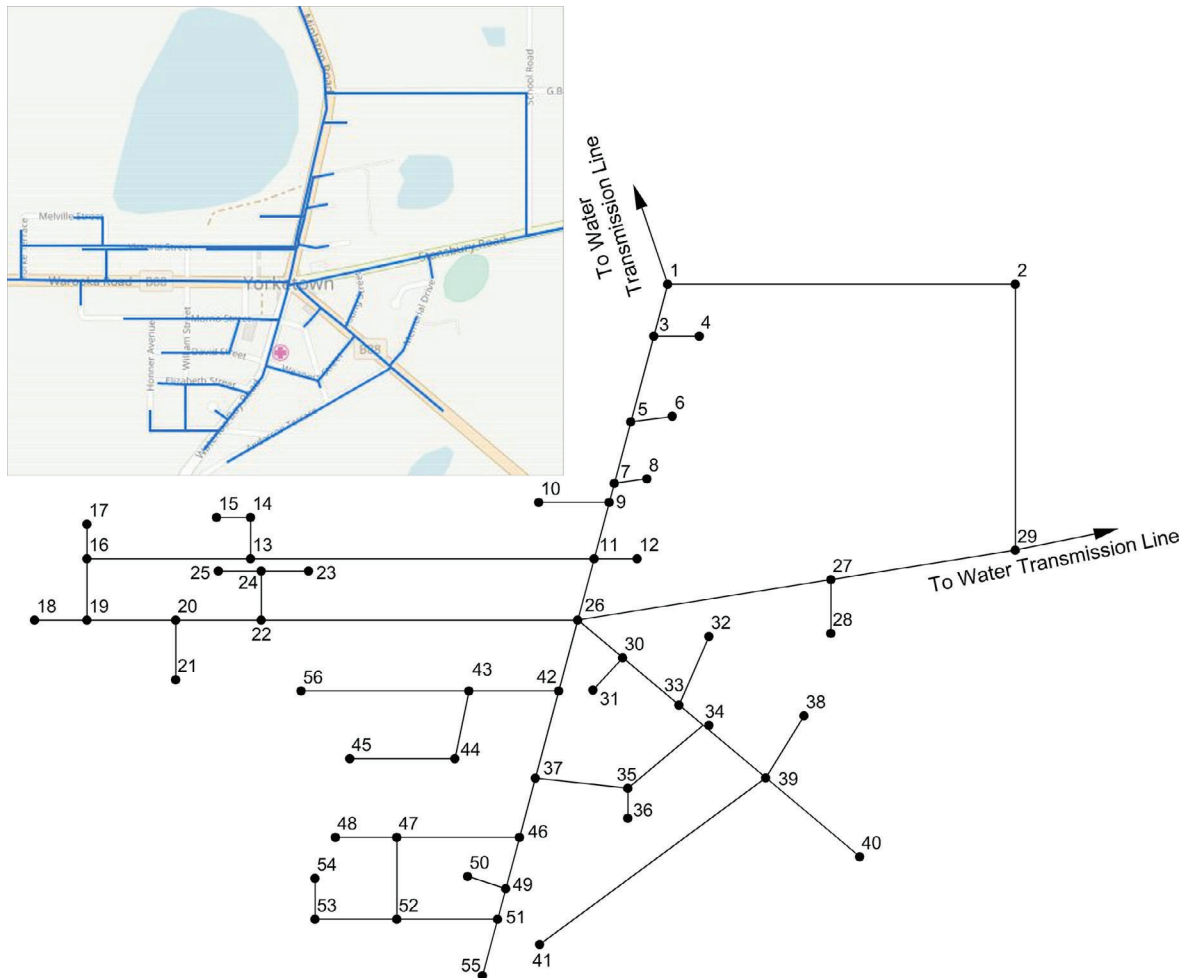


Fig. 6. Case study 2: Yorktown water distribution network.

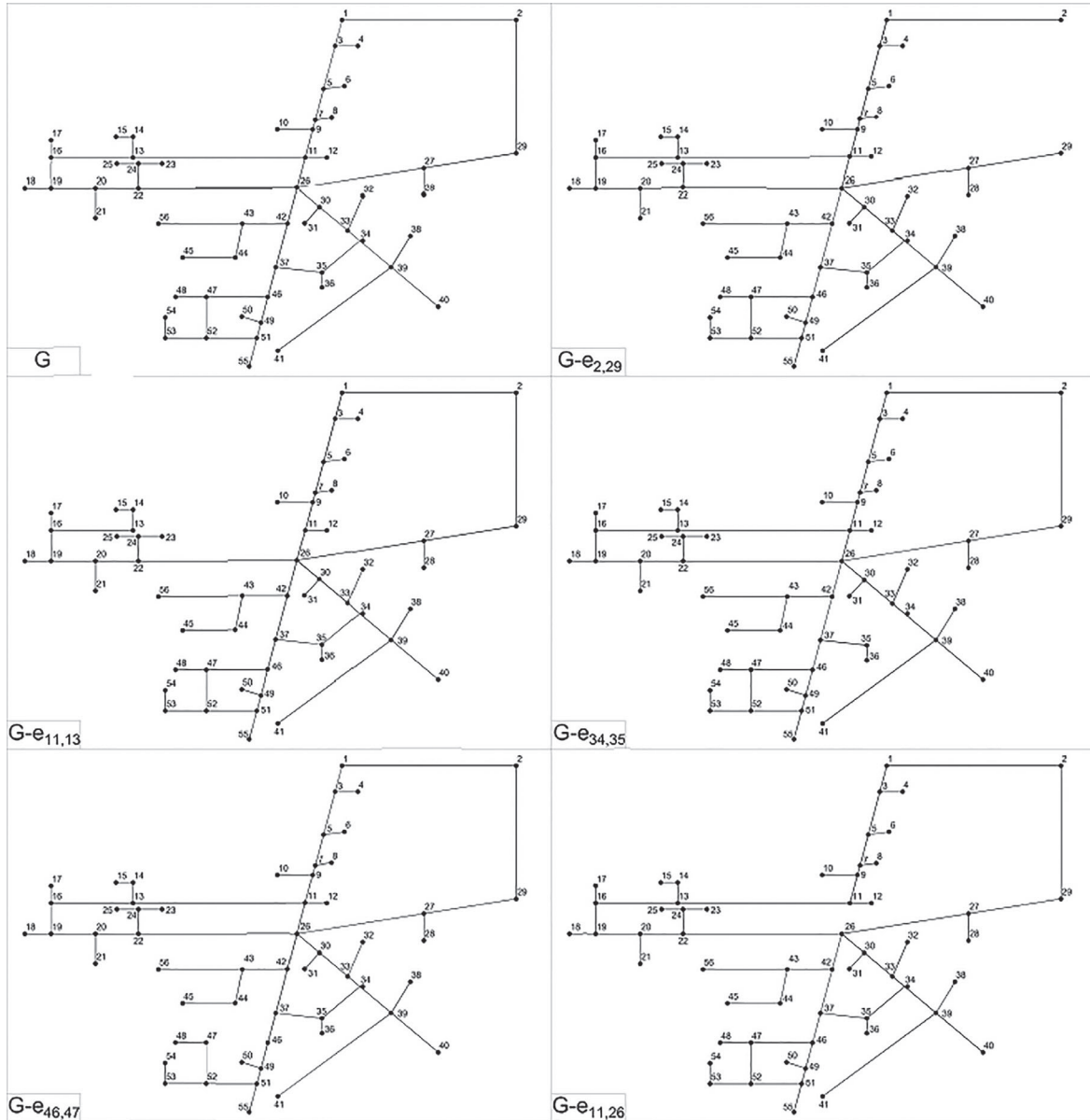


Fig. 7. Six different layouts of the second case study.

The same procedure as the previous case study can be used for calculation of  $R_{CB}$  for this case. The parameter used for obtaining  $R_{CB}$  is presented in Table 6, Appendix A.

Table 6 indicated that for all pipes located on the non-closed chain of connected edges (trees), the value of  $CEB$  is zero, which confirms the non-redundant attribute of a tree-shaped structure.

As expected, the  $CEB$  identifies the pipe between nodes 11 and 26 as the most redundant pipe in the network, with  $CB(e_{11,26}) = 0.0543$ . Intuitively, this is because many alternative paths would have to pass through this pipe due to its central location, and therefore this pipe attains a higher value of redundancy as compared with the other pipes in the networks.

As shown in Table 6, all pipes that are symmetrically placed in a given loop take on the same value of  $CEB$ . For example  $CB(e_{46,47}) = CB(e_{47,52}) = CB(e_{51,52}) = CB(e_{49,51}) = CB(e_{46,49}) = 0.05$ . Consideration of the discussion presented for the first case study, makes this an unsurprising result.

Using Eq. (9) and extending the analysis further to the global level, we are now able to measure the redundancy of the network as a whole.

Since  $m = 59$ , given that  $H_{CBmax} = 5.8826$  bits (Presented in Table 6), we obtain  $R_{CB} = 0.8094$ . The resulting redundancy index values in both case studies conform to expectations. Comparatively, the higher value of the redundancy index in the first case study is a result of a higher connectivity due to a stronger looped-network structure than that of the second study.

We now catch the difference between the proposed redundancy index and the conventional redundancy measures for six different layouts of this case study (see Fig. 7). As per the previous cast study, in each layout a pipe is removed and the sensitivity of each metric to the changes in layout is investigated.

We assume  $G - e_{i,j}$  as the layout resulted from this case study by removal of a pipe between nodes  $i$  and  $j$ . Table 5 reports the numerical values of the redundancy metrics for these layouts. For a better visualization, Fig. 8 illustrates these values. For additional information, regarding the number of cospanning trees and cospanning edges of different layouts the reader is referred to Table 7 in Appendix B.

As can be seen in Fig. 8, despite the major differences in the configuration of pipes, the *Meshedness coefficient* and *Edge density* do not

**Table 5**  
Numerical values of redundancy metrics (case study 2).

Layout	$R_{CB}$	$E_d$	$r_m$	$CC_T$
$G$	0.8094	0.0383	0.0374	0
$G - e_{(2,29)}$	0.7221	0.0376	0.0280	0
$G - e_{(11,13)}$	0.7513	0.0376	0.0280	0
$G - e_{(34,35)}$	0.7393	0.0376	0.0280	0
$G - e_{(46,47)}$	0.7668	0.0376	0.0280	0
$G - e_{(11,26)}$	0.7845	0.0376	0.0280	0

discriminate between different layouts and give a constant value for majority of the layouts. These metrics assign the equal level of redundancy to these layouts, whereas as it can be perceived the redundancy value is different for each layout. These two metrics are only dependent on the cardinality of edges and nodes set, thereby rendering them unable to accurately measure the redundancy of the network. They can be used just as an approximate quantifier of the topology of a network, hence they are not appropriate measures to quantify the redundancy of networks.

Moreover, despite the redundant characteristic of all layouts, the *Clustering coefficient* leaves the redundancy at the value of zero. This can be ascribed to the definition of this metric in which only the presence of the loops of order three is measured. This is another proof that simple counting of the number of triangles in a network does not discriminate between different layouts and therefore fails to characterize the redundancy of a network [7].

The range of  $R_{CB}$  reported in Fig. 8 highlights a direct correlation between the number of cospanning edges and the proposed redundancy index. This can be attributed to the existence of more alternative paths in the layouts with a higher number of cospanning edges, which in turn leads to a higher value of the proposed redundancy index.

On the basis of the preceding observations, on contrary to the conventional metrics, the new redundancy index does not depend on the density of triangles nor the number of nodes and edges, but on the

configuration of pipes and their contribution to overall redundancy of the network. Thus,  $R_{CB}$  proves better performance in its ability to capture the inherent structural redundancy of WDNs due to highlighting the importance of each individual pipe from the redundancy perspective as well as measuring the diversity of alternative paths in the network.

#### 4. Conclusions

The method described in this paper represents a two-tiered approach for analyzing the redundancy of WDNs. The proposed approach goes behind the hydraulic perspective often used to evaluate the redundancy of WDNs, and provides an integrated framework by coupling the cospanning tree technique and the informational entropy theory, within which not only the local redundancy of a pipe is measured, but also the contribution of the pipe to the global redundancy of the network is evaluated.

One tier is explicitly tied to evaluate the local redundancy of pipes by developing a new quantitative measure of a pipe importance, termed *Cospanning Edge Betweenness*, by which pipes can be ranked according to their redundancies. *CEB* can be regarded as a measure of choices as to an event whereby an edge is a part of a cospanning tree.

Heterogeneity and homogeneity of *CEBs* form the basis for evaluating the overall redundancy of the network in tier two. Rooted in entropy theory, the second tier proposes a new redundancy index for measuring the global redundancy of WDNs. The so called *Entropy-Based Cospanning Redundancy Index*,  $R_{CB}$ , is developed from the informational entropy based on the probability distribution of *CEBs*, which can be interpreted as a measure of the overall redundancy of the network yielded by cospanning edges. The entropy-based analysis reveals that for a given set of cospanning edges, the maximum global redundancy occurs when participation of these edges in the cospanning trees are equally likely.

Using two case studies, a real world WDN and a hypothetic illustrative example, this paper has compared the effectiveness of the proposed redundancy index with the conventional metrics, concluding that  $R_{CB}$  performs better at measuring the local and global redundancy of a network. As the comparative analysis reveals, the new redundancy index is in consistent with the intuitive notion of redundancy, which reflects the multiplicity of alternative paths guaranteeing the connectivity of the network.

This article makes contribution by way of offering a new insight for analyzing the redundancy of WDNs. By situating our research in the graph theory context, we compensate the absence of topological characteristics of WDNs in the existing redundancy evaluation methods. We attempt to develop the application of cospanning tree technique beyond the borders of graph theory. On this premise, the cospanning tree technique is applied to the WDNs domain in which it has not been applied yet. Moreover, this research demonstrates how the probabilistic measure of the network uncertainties and choices, using the informational entropy, gives a vivid account of an overall network redundancy.

Of course, this approach is not a panacea. The proposed method is a complement to, not a replacement for, the hydraulic redundancy approaches. A realistic assessment of the network redundancy should shift away from a pure topological viewpoint or an exclusive hydraulic analysis towards a combined topological and hydraulic approach [46].

By taking a new angle on redundancy evaluation of WDNs, we hope to open up new research directions in the redundancy context. In this respect, future research can build upon our current approach by incorporating more topological features into the method. Additionally, in an attempt to shift away from a pure hydraulic approach or an exclusive topological view point, forthcoming work might seek to develop a new hybrid method which incorporates topological as well as hydraulic charac-

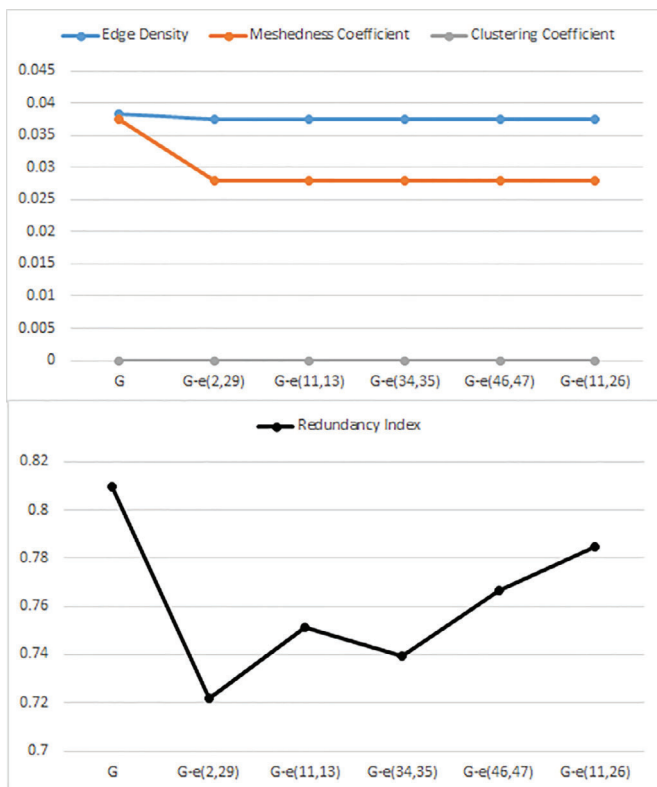


Fig. 8. Redundancy measures for different scenarios (case study 2).

terizations of WDNs. Furthermore, generating cospanning trees of large networks is generally a time-consuming step and therefore presents a challenge. It would be helpful if further research could engage in developing algorithms, which reduce the computational efforts for calculating CEBs.

Appendix A

**Table 6**  
The parameters used for obtaining  $R_{CB}$  – case study 2.

$e_i$ (Node $i$ to $j$ )	$n_{T^*}(e_i)$	$CB(e_i)$	$CB(e_i)\log_2 CB(e_i)$
1–2	245	0.0254	-0.1346
2–29	245	0.0254	-0.1346
29–27	245	0.0254	-0.1346
27–26	245	0.0254	-0.1346
26–11	525	0.0543	-0.22822
11–9	245	0.0254	-0.1346
9–7	245	0.0254	-0.1346
7–5	245	0.0254	-0.1346
5–3	245	0.0254	-0.1346
3–1	245	0.0254	-0.1346
11–13	350	0.0362	-0.17332
13–16	350	0.0362	-0.17332
16–19	350	0.0362	-0.17332
19–20	350	0.0362	-0.17332
20–22	350	0.0362	-0.17332
22–26	350	0.0362	-0.17332
26–30	345	0.0357	-0.17164
30–33	345	0.0357	-0.17164
33–34	345	0.0357	-0.17164
34–35	345	0.0357	-0.17164
35–37	345	0.0357	-0.17164
37–42	345	0.0357	-0.17164
42–26	345	0.0357	-0.17164
46–47	483	0.05	-0.2161
47–52	483	0.05	-0.2161
52–51	483	0.05	-0.2161
51–49	483	0.05	-0.2161
49–46	483	0.05	-0.2161
Other pipes	0	0	0
$\sum_{i=1}^m CB(e_i)\log_2 CB(e_i)$			-4.76148
$H_{CBmax} = \log_2 59 = 5.8826$			
$R_{CB} = 0.8094$			

Appendix B

**Table 7**  
Number of cospanning trees and cospanning edges of different layouts – case study 2.

Layout	Number of cospanning trees	Number of cospanning edges
$G$	2415	9660
$G - e_{(2,29)}$	245	735
$G - e_{(11,13)}$	350	1050
$G - e_{(34,35)}$	345	1035
$G - e_{(46,47)}$	483	1449
$G - e_{(11,26)}$	525	1575

References

[1] Ardakan MA, Rezvan MT. Multi-objective optimization of reliability-redundancy allocation problem with cold-standby strategy using NSGA-II. Reliab Eng Syst Saf 2018;172(2018):225–38.  
 [2] Agrawal ML, Gupta R, Bhawe PR. Optimal design of level-1 redundant water distributions considering nodal storage. J Environ Eng 2007;133(3):319–30.  
 [3] Alvisi L, Creaco E, Franchini M. Segment identification in water distributions. Urban Water J 2011;8(4):203–17.

[4] Awumah K, Goulter I, Bhatt SK. Entropy-based redundancy measures in water distribution networks. J Hydraul Eng 1991;117(5):595–614.  
 [5] Buhl J, Gautrais J, Reeves N, Sole RV, Valverde S, Kuntz P, Theraulaz G. Topological patterns in street networks of self-organized urban settlements. Eur Phys J B-Condens Matter Complex Syst 2006;49(4):513–22.  
 [6] Cadini F, Zio E, Petrescu A. Using centrality measures to rank the importance of the components of a complex network infrastructure. Lect Notes Comput Sci 2009;5508:155–67.  
 [7] Cardillo A, Scellati S, Latora V, Porta S. Structural properties of planner graphs of urban street patterns. Phys Rev E 2006;73(6):066107.  
 [8] Creaco E, Franchini M, Alvisi S. Evaluating water demand shortfalls in the segmental analysis. Water Resour Manage 2012;26(8):2301–21.  
 [9] Cuarda L, Salcedo-Sanz S, Delsler J, Fernandez ST, Geem ZW. A critical review of robustness in power grids using complex networks concept. Energies 2015;8(9):9211–65.  
 [10] Di Nardo A, Di Natale M. A heuristic design support methodology based on graph theory for district metering of water supply networks. Eng Optim 2011;43(2):193–211.  
 [11] Di Nardo A, Cavallo A, Di Natale M, Greco R, Giovanni FS. Dynamic control of water distribution system based on network partitioning. Procedia Eng 2016;154(2016):1275–82.  
 [12] Di Nardo A, Di Natale M, Giudicianni C, Musmarra D, Rodriguez Varela JM, Santonastaso GF, Simone A, Tzatchkov V. Redundancy features of water distribution systems. Procedia Eng 2017;186(2017):412–19.  
 [13] Goulter IC. Current and future use of systems analysis in water distribution network design. Civil Eng Syst 1987;4(4):175–84.  
 [14] Gunawan I, Schultmann F, Zarghami SA. The four Rs performance indicators of water distribution networks: a review of research literature. Int J Qual Reliab Manag 2017;34(5):720–32.  
 [15] Gupta R, Baby A, Arya PV, Ormsbee L. Segmented-based reliability/supply shortfall analysis of water distribution networks. Procedia Eng 2014;89(2014):1168–75.  
 [16] Gupta R, Bhawe PR. Reliability-based design of water distribution systems. J Environ Eng 1996;122(1):51–4.  
 [17] Gupta R, Kakwani N, Ormsbee L. Optimal upgrading of water distribution networks redundancy. J Water Resour Plann Manage 2015;141(1):1–11.  
 [18] Gupta R, Lakshmi BY, Sayeed MA, Rathi S. Comparison of flow distribution models for design of water distribution networks with redundancy. Procedia Eng 2014;89(2014):848–55.  
 [19] Hernandez-Fajardo I, Dueñas-Osorio L. Probabilistic study of cascading failures in complex interdependent lifeline systems. Reliab Eng Syst Saf 2013;111(2013):260–72.  
 [20] Hoshiya M, Yamamoto K. Redundancy index of lifeline systems. J Eng Mech 2002;128(9):961–8.  
 [21] Johansson J, Hassel H, Zio E. Reliability and vulnerability analysis of critical infrastructures: comparing two approaches in the context of power systems. Reliab Eng Syst Saf 2013;120(2013):27–38.  
 [22] Kalungi P, Tanyimboh TT. Redundancy model for water distribution systems. Reliab Eng Syst Saf 2003;82(3):275–86.  
 [23] Kessler A, Ormsbee L, Shamir U. A methodology for least cost design of invulnerable water distribution networks. Civil Eng Syst 1990;7(1):20–8.  
 [24] Kim H, Kim P. Reliability-redundancy allocation problem considering optimal redundancy strategy using parallel genetic algorithm. Reliab Eng Syst Saf 2017;159(2017):153–60.  
 [25] Levitin G, Finkelstein M, Dai Y. Redundancy optimization for series-parallel phased mission systems exposed to random shocks. Reliab Eng Syst Saf 2017;167(2017):554–60.  
 [26] Mays LW, Cullinane J. 1986. A review and evaluation of reliability concept for design of water distribution systems. No.WES/MP/EL-86-1. U.S Army Engineer Waterways Experiment Station, Vicksburg MS Environmental Lab.  
 [27] Onnela JP, Saramaki J, Kertez J, Kaski K. Intensity and coherent of motifs in weighted complex network. E, Stat Nonlinear Soft Matter Phys 2005;71(6):1–4.  
 [28] Prasad TD, Park NS. Multiobjective genetic algorithms for design of water distribution networks. J Water Resour Plann Manage 2004;130(1):73–82.  
 [29] Qi X, Fuller E, Luo R, Zhang CQ. A novel centrality method for weighted networks based on the Kirchhoff polynomial. Pattern Recognit Lett 2015;58:51–60.  
 [30] SA Water. Water main replacement program, <http://sawater.maps.arcgis.com/apps/View/index.html?appid=afdd0293e7834256beb889b205f8b830>, viewed 5th February 2018.  
 [31] Shannon CE. A mathematical theory of communication. Bell Syst Tech J 1948;27(3):379–423.  
 [32] Singh VP, Oh J. A Tsallis entropy-based redundancy measures for water distribution networks. Physica A: Stat Math Appl 2015;421:360–76.  
 [33] Shuang Q, Zhang M, Yuan Y. Node vulnerability of water distribution networks under cascading failures. Reliab Eng Syst Saf 2014;124(2014):132–41.  
 [34] Ormsbee L, Kessler A. Optimal upgrading of hydraulic network reliability. J Water Resour Plann Manage 1990;116(6):784–802.  
 [35] Tanyimboh TT. Informational entropy: a failure tolerance and reliability surrogate for water distribution networks. Water Resour Manage 2017;31(10):3189–204.  
 [36] Tanyimboh TT, Siew C, Saleh S, Czajkowska A. Comparison of surrogate measures for the reliability and redundancy of water distribution systems. Water Resour Manage 2016;30(10):3535–52.  
 [37] Teixeira AS, Monteiro PD, Carrico JA, Ramirez M, Francisco AP. Not seeing the forest for the trees: size of the minimum spanning trees (MSTs) forest and branch significance in MST-based phylogenetic analysis. PLoS One 2015;10(3):1–15.  
 [38] Teixeira AZ, Santos FC, Francisco AP. Spanning edge betweenness in practice. Stud. Comput. Intell. 2016;644:3–10.



- [39] Todini E. Looped water distribution networks design using a resilience index based heuristic approach. *Urban Water* 2000;2(2):115–22.
- [40] Wagner JM, Shamir U, Marks DH. Water distribution reliability: analytical methods. *J Water Resour Plann Manage* 1988;114(3):253–75.
- [41] Wilson RJ. Introduction to graph theory. Fourth ed. Harlow, Essex, England: Addison Wesley Longman; 1956.
- [42] Wright R, Abraham E, Pappas P, Stoianov I. Control of water distribution networks with dynamic DMA topology using strictly feasible sequential convex programming. *Water Resour Res* 2015;51(12):9925–41.
- [43] Yazdani A, Jeffrey P. Complex network analysis of water distribution systems. *Chaos: Interdiscip J Nonlinear Sci* 2011;21(1):016111.
- [44] Yazdani A, Jeffrey P. Applying network theory to quantify the redundancy and structural robustness of water distribution systems. *J Water Resour Plann Manage* 2012;138(2):153–61.
- [45] Yazdani A, Otoo RA, Jeffrey P. Resilience enhancing expansion strategies for water distribution systems: a network theory approach. *Environ Modell Softw* 2011;26(12):1574–82.
- [46] Zarghami SA, Gunawan I, Schultmann F. 2018. Measuring robustness of water distribution networks using informational entropy. In Proceedings of the 8th international conference on industrial engineering and operations management: 3331–3339.
- [47] Ziha K. Event oriented system analysis. *Probab Eng Mech* 2000;15(3):261–75.
- [48] Ziha K. Redundancy and robustness of systems of events. *Probab Eng Mech* 2000;15(4):347–57.

# *Chapter 5*

## Importance-Based Reliability Analysis

## 5. Importance-Based Reliability Analysis

### 5.1. Paper 5: Entropy of centrality values for topological vulnerability analysis of water distribution networks

#### Statement of Authorship

Title of Paper	Entropy of centrality values for topological vulnerability analysis of water distribution networks		
Publication Status	<input checked="" type="checkbox"/> Published	<input type="checkbox"/> Accepted for Publication	
	<input type="checkbox"/> Submitted for Publication	<input type="checkbox"/> Unpublished and Unsubmitted work written in manuscript style	
Publication Details	Zarghami S.A., Gunawan, I., & Schullmann, F. (2019). Entropy of centrality values for topological vulnerability analysis of water distribution networks. <i>Built Environment Project and Asset Management</i> . 9(3): 412-425.		

#### Principal Author

Name of Principal Author (Candidate)	Seyed Ashkan Zarghami		
Contribution to the Paper	Design the model and computational framework- Developing the theory- Proposing a new method- Performing the analytic calculations- Demonstrating the proposed method on case studies-Discussion of results- Identifying avenues for future work- Writing the manuscript		
Overall percentage (%)	85%		
Certification:	This paper reports on original research I conducted during the period of my Higher Degree by Research candidature and is not subject to any obligations or contractual agreements with a third party that would constrain its inclusion in this thesis. I am the primary author of this paper.		
Signature		Date	01/06/2019

#### Co-Author Contributions

By signing the Statement of Authorship, each author certifies that:

- the candidate's stated contribution to the publication is accurate (as detailed above);
- permission is granted for the candidate to include the publication in the thesis; and
- the sum of all co-author contributions is equal to 100% less the candidate's stated contribution.

Name of Co-Author	Associate Professor Indra Gunawan		
Contribution to the Paper	Supervising development of the work- Verifying the numerical results- Evaluation of the manuscript- Helping to edit the manuscript-Final approval of the version to be published		
Signature		Date	8/8/19

Name of Co-Author	Professor Frank Schullmann		
Contribution to the Paper	Supervising development of the work -Helping to edit the manuscript- Final approval of the version to be published		
Signature		Date	01/08/2019

Please cut and paste additional co-author forms if required.

# Entropy of centrality values for topological vulnerability analysis of water distribution networks

Seyed Ashkan Zarghami, Indra Gunawan and Frank Schultmann  
*Entrepreneurship, Commercialisation and Innovation Centre (ECIC),  
The University of Adelaide, Adelaide, Australia*

Received 16 February 2019  
Revised 11 April 2019  
Accepted 11 April 2019

## Abstract

**Purpose** – The increased complexity of water distribution networks (WDNs) emphasizes the importance of studying the relationship between topology and vulnerability of these networks. However, the few existing studies on this subject measure the vulnerability at a specific location and ignore to quantify the vulnerability as a whole. The purpose of this paper is to fill this gap by extending the topological vulnerability analysis further to the global level.

**Design/methodology/approach** – This paper introduces a two-step procedure. In the first step, this work evaluates the degree of influence of a node by employing graph theory quantities. In the second step, information entropy is used as a tool to quantify the global vulnerability of WDNs.

**Findings** – The vulnerability analysis results showed that a network with uniformly distributed centrality values exhibits a lower drop in performance in the case of partial failure of its components and therefore is less vulnerable. In other words, the failure of a highly central node leads to a significant loss of performance in the network.

**Practical implications** – The vulnerability analysis method, developed in this work, provides a decision support tool to implement a cost-effective maintenance strategy, which relies on identifying and prioritizing the vulnerabilities, thereby reducing expenditures on maintenance activities.

**Originality/value** – By situating the research in the entropy theory context, for the first time, this paper demonstrates how heterogeneity and homogeneity of centrality values measured by the information entropy can be interpreted in terms of the network vulnerability.

**Keywords** Information entropy, Betweenness centrality, Closeness centrality, Eigenvector centrality, Vulnerability analysis, Water distribution networks

**Paper type** Research paper

## 1. Introduction

Water distribution networks (WDNs) have been identified by many countries as national strategic assets that should be highly valued and efficiently managed. However, with the ageing of these networks, numerous problems are emerging such as pipe bursts, leakage, water quality degradation, water supply interruption and loss of hydraulic performance. Consequently, maintenance expenditures are becoming the major driver of capital expenditure in the water sector. This coupled with budget constraints for the maintenance activities reinforces the need to accurately identifying vulnerabilities and prioritizing water pipeline assets (Zamenian *et al.*, 2017).

Vulnerability analysis of WDNs has been an active area of past research. Shuang *et al.* (2014a) evaluated the nodal vulnerability of WDNs under cascading failure by monitoring pressure in nodes and flows in pipes during the cascading process. Fragiadakis and Christodoulou (2014) and Fragiadakis *et al.* (2016) performed a seismic hydraulic vulnerability assessment of urban water networks using survival analysis. Shuang *et al.* (2015) suggested different recovery strategies of WDNs, focusing on the vulnerability of nodes due to exceeding their hydraulic (pressure) capacity. Laucelli and Giustolisi (2015) evaluated the vulnerability of WDNs under seismic actions using a hydraulic modeling paradigm taking into account unsupplied demand to customers.

Such studies approach the vulnerability analysis of WDNs from a hydraulic perspective, which is concerned with satisfying flow and pressure requirements. These studies take into



---

consideration factors such as failures due to demand variation, undersized pipes, storage capacity, insufficient pressure or a combination of these factors (Zhuang *et al.*, 2013). However, due to the complex interactions among a large number of subsystems and components, the exclusive hydraulic analysis of WDNs just partially describes the network performance (Gunawan *et al.*, 2017). On this premise, the topological vulnerability analysis, as a complementary approach, provides a robust model, thereby assessing the vulnerability of WDNs more accurately (Yazdani *et al.*, 2011).

There is a small body of literature, which analyzes the vulnerability of WDNs from the topological point of view. The topological vulnerability analysis refers to analyzing the configuration of the network based on graph theory techniques (Di Nardo and Di Natale, 2011). Perelman and Ostfeld (2011) constructed a topological connectivity matrix aimed at clustering the nodes in WDNs based on their connectivity, thereafter identifying weakly and strongly connected clusters. Yazdani and Jeffrey (2011, 2012) examined the vulnerability of WDNs to the failure of individual components by identifying the critical components using metrics from graph theory. Sheng *et al.* (2013) adopted a complex network-based model for exploring the malfunction of WDNs by measuring the spectral properties and subsequently identifying the isolated communities.

The approaches discussed above assess the vulnerability of WDNs by adopting very generic topological properties of the network within which mainly the vulnerability problem at the local level is addressed. While identifying the critical components through performing a vulnerability analysis at a specific location is of great importance, studies on how to quantify the vulnerability of a WDN as a whole remain scant. As the literature review revealed, little effort has gone to developing quantitative metrics through which the global vulnerability can be measured. A global vulnerability index can provide insight into the current vulnerability of the network. In fact, this index can be used as a benchmark to determine the vulnerabilities in WDNs. It also allows for measuring the extent of improvement in the reliability of the network after the implementation of maintenance strategies.

The theme of this paper is the development of a novel methodology for local and global vulnerability analysis of WDNs. The proposed methodology includes two stages. In the first stage, the graph theory quantities known as closeness, eigenvector and betweenness centrality are employed in order to prioritize the nodal components in WDNs. This stage evaluates the vulnerability of a WDN at the local level based on the importance of its components. In the second stage, the potential of using Shannon (information) entropy as a means to measure the homogeneity and heterogeneity of the centrality values is explored. Accordingly, this work develops a new vulnerability index and demonstrates how heterogeneity and homogeneity of the centrality values measured by the information entropy can be interpreted in terms of the network vulnerability.

The rest of the paper is structured according to the following plan. Section 2 recalls the basic definitions of the three most commonly used centrality measures. Section 3 develops the proposed method and details the procedural steps to evaluate the vulnerability of WDNs. In Section 4, the paper presents two case studies, a real-world WDN of an Australian town and a network from the literature, as illustrations of the proposed method. Conclusions are drawn in Section 5, followed by a discussion of the avenues for future research.

## 2. Centrality analysis

The centrality of elements in a network is concerned with the identification of the elements with a more central role than others (Qi *et al.*, 2012). In recent years, a number of centrality measures have been devised to evaluate the importance of nodes and links in a network, within which different dimensions of the intuitive notion of the centrality are addressed (Brandes *et al.*, 1999). Centrality measures have mainly focused on solving the problem of revealing the importance of elements by measuring the various network topologies.

Broadly classified by Boldi and Vigna (2013), these measures can be categorized into the three following types:

- (1) Geometric measures where the importance of an element is a function of distances. The examples of centrality measures in this category are indegree, closeness, Lin's index and harmonic centrality.
- (2) Spectral measures such as Seeley's index, Katz's index, PageRank and eigenvector centrality, which are based on the left dominant eigenvector of a network adjacency matrix or some other matrix derived from it.
- (3) Path-based measures that assess the importance of a component based on the number of paths or shortest path passing through the component. Stress, betweenness and k-path centrality are the most well-known examples of this category.

A review of the existing literature indicates the presence of confusion in what centrality measure scores best compared to others. In order to capture various topological characteristics of a network, this research identifies the most central nodes in a network by adopting an exemplary centrality measure from each of the abovementioned categories. These centrality measures are closeness centrality as a geometric measure, eigenvector centrality as a spectral measure and betweenness centrality as a path-based measure. These three centrality measures are the most widely used centrality measures and set the basis for the development of other mathematically related measures (Lozares *et al.*, 2015).

Closeness centrality was first introduced by Bavelas (1950) and can be explained as a mean distance from a given node to other nodes in a network. Closeness centrality indicates how close a given node is with respect to the entire network and can be formulated as follows:

$$C_C(i) = \frac{n-1}{\sum_j d_{ij}}, \quad (1)$$

where  $C_C(i)$  represents the closeness centrality,  $n$  is the number of nodes in the network and  $d_{ij}$  denotes the shortest path lengths between node  $i$  and  $j$ .

Betweenness centrality is based on the idea that a given node is central if it lies between many other nodes (Cadini *et al.*, 2009). Betweenness centrality of node  $i$ ,  $C_B(i)$ , is defined as the number of shortest paths between pairs of nodes that pass through a given node and can be stated by the following formula:

$$C_B(i) = \frac{1}{(n-1)(n-2)} \sum_{s \neq r \neq i} \frac{n_{s,r}(i)}{n_{s,r}}, \quad (2)$$

where  $n$  is the number of nodes in the network,  $n_{s,r}(i)$  denotes the number of shortest paths between  $s$  and  $r$  passing through  $i$  and  $n_{s,r}$  represents the number of shortest paths between  $s$  and  $r$ .  $C_B(i)$  takes on values between 0 and 1 and attains its maximum value when node  $i$  falls on all shortest paths between two nodes.

Eigenvector centrality of a node takes into account the combined centrality values of its neighbors based on the philosophy that a given node is more central if its neighbors are also highly central (Joyce *et al.*, 2010). The mathematical expression of the eigenvector centrality of node  $i$ ,  $C_e(i)$ , can be expressed as per the following equation:

$$C_e(i) = \frac{1}{\lambda} \sum_{j \rightarrow i} C_e(j), \quad (3)$$

$$\lambda e = Ae,$$

where  $A$  is the adjacency matrix,  $e$  denotes the eigenvector centrality of all nodes and  $\lambda$  is the largest eigenvector of the adjacency matrix.

Centrality measures evaluate the impact of each node on the network performance and provide a numerical indicator to identify the network's most influential components. However, stand-alone use of these metrics yields insufficient information as to the weaknesses of a network. An attempt is made in the following section to provide a solution to this problem by proposing a vulnerability index based on the joint entropy of the distribution of centrality values.

### 3. An entropy-based vulnerability index

In this section, the expected level of the network vulnerability is evaluated by computing the Shannon entropy of centrality values. Shannon entropy, introduced by Shannon (1948), is a widely used evaluated measure of choice, uncertainty and heterogeneity of a set of probabilities, which can be expressed by the following equation:

$$H = - \sum_{i=1}^n p_i \log_b p_i, \quad (4)$$

where  $H$  is the entropy of distribution,  $p_i$  is the probability associated with the  $i$ th outcome,  $n$  denotes the number of possible outcomes and  $b$  is an arbitrary logarithm base indicating the unit of entropy. For example, for  $b = 2$ ,  $b = e$  and  $b = 10$ , the unit of entropy is, respectively, defined as bit, Napier and decibels (Zarghami *et al.*, 2018). By definition,  $0 \leq H \leq \log_b n$ . The lower extreme value,  $H = 0$ , occurs when one of the probabilities is 1 and the rest take on the value of 0, whereas the upper extreme value,  $H = \log_b n$ , occurs when all the probabilities are of equal value of  $1/n$ .

Shannon introduced Equation (4) for complete probability distributions, where  $\sum_{i=1}^n p_i = 1$ . In order to follow the definition proposed by Shannon, the normalized form of each centrality value is used by scaling it to the  $[0, 1]$  interval.

Let  $CC = \{C_C(i): i = 1, 2, \dots, m\}$ ,  $CE = \{C_E(i): i = 1, 2, \dots, m\}$  and  $CB = \{C_B(i): i = 1, 2, \dots, m\}$  be, respectively, a set of closeness, eigenvector and betweenness centrality values for a network with  $m$  edges. Let assume  $C_M(i)$  as a symbolic representation of a given centrality value of node  $i$  such that  $C_M(i) \in \{CC \text{ or } CE \text{ or } CB\}$ . The normalized centrality is then defined as the ratio of a given centrality value to the sum of all values of the given centrality measure, as such  $\sum_{i=1}^{n_d} C_M(i) = 1$ . The normalized centrality of node  $i$ ,  $PC_M(i)$ , can be stated as follows:

$$PC_M(i) = \frac{C_M(i)}{\sum_{i=1}^{n_d} C_M(i)}. \quad (5)$$

As can be seen from Equation (5), in order to obtain  $PC_M(i)$ , the value of centrality from a given set of centrality is scaled relative to the sum of all centrality values of the set. Therefore,  $PC_M$  provides a numerical indicator to evaluate the relative influence of a node in a network.

By substituting  $PC_M(i)$ , Equation (4) can be restated as follows:

$$H_{CM} = - \sum_{i=1}^m PC_M(i) \log_2 PC_M(i), \quad (6)$$

where the notation of  $H_{CM}$  is a symbolic representation of the entropy of a given set of centrality values, meaning that  $H_{CM} = H_{CC}$  if  $C_M(i) \in CC$ ,  $H_{CM} = H_{CE}$  if  $C_M(i) \in CE$  and  $H_{CM} = H_{CB}$  if  $C_M(i) \in CB$ .

As stated earlier, to achieve a more accurate result for evaluating the global vulnerability of a network, it is now time to combine the entropy of individual centrality measures by means of joint entropy of the three centrality measures.

The joint entropy of three variables,  $H(X_1, X_2, X_3)$ , with a set of joint probability of  $\{p_{ijk}: i = 1, 2, \dots, N; j = 1, 2, \dots, M; k = 1, 2, \dots, P\}$ , is defined as:

$$H(X_1, X_2, X_3) = - \sum_{i=1}^N \sum_{j=1}^M \sum_{k=1}^P p_{ijk} \log(p_{ijk}) \leq H(X_1) + H(X_2) + H(X_3). \quad (7)$$

Since  $C_C(i)$ ,  $C_E(i)$  and  $C_B(i)$  are statistically independent variables, their joint entropy can be obtained from the following mathematical expression:

$$H_{CT} = H_{CC} + H_{CE} + H_{CB}. \quad (8)$$

Intuitively, failure of a junction node with a high centrality value results in the disruption of the service for many nodes in the network due to its central location. Therefore, in the case where all junction nodes are of equal value of centrality, the debilitating effect on the network performance due to the failure of each individual node will be minimum. This intuitive description is very reminiscent of the principle of Shannon entropy, which is a decreasing function of scattering of random variables, and attains its maximum value when all the outcomes are equally likely (Maszczyk and Duch, 2008).

In a network with  $m$  junction nodes, when all centrality values are equally likely,  $H_{CT}$  is maximum when  $PC_C = PC_E = PC_B = 1/m$ , thus:

$$H_{CC, \max} = H_{CE, \max} = H_{CB, \max} = -\log_2 m. \quad (9)$$

By substituting these values into Equation (8):

$$H_{CT, \max} = H_{CC, \max} + H_{CE, \max} + H_{CB, \max} = -3\log_2 m. \quad (10)$$

The vulnerability index, VI, can be constructed based on the fractional differences between  $H_{CT}$  and maximum achievable  $H_{CT}$ . Thus, VI is defined as one minus the relative entropy as follows:

$$VI = 1 - \frac{H_{CT}}{H_{CT, \max}}. \quad (11)$$

The vulnerability index of the network falls within the range of  $[0, 1]$ , where a higher value of VI indicates the higher vulnerability, whereas a lower value implies the lower vulnerability. VI represents the comparative heterogeneity of the centrality values defined by  $H_{CT}$  with respect to the maximum possible entropy value where all values are uniformly distributed (Singh, 2013). VI attains its minimum value ( $VI = 0$ ), when  $\{PC_M(i) | i = 1, 2, \dots, m\}$  is uniformly distributed. Theoretically, this case corresponds to the situation where all components in the network are equally central.

VI describes how severe the consequences of random failures may be. It refers to the likely magnitude of failures. That is, in a homogeneous case where the nodes in the system are almost equally central, the severity of the random failure of a node is lesser than that of the case when some nodes are highly central and others are peripherals. In other words, when a very few central nodes dominate the network, the failure of each of these nodes leaves a large number of nodes disconnected, which implies the severity of the failure and consequently a high vulnerability of the network.



#### 4. Application

In order to illustrate the proposed vulnerability assessment method and to evaluate the effectiveness of the new vulnerability index, this section presents two contrasting case studies. These two case studies represent two different extreme layouts of WDNs: a strongly looped layout and a branched configuration of pipeline assets. These two contrasting case studies are used to investigate the possibility to generalize the application of the proposed method to different WDNs with different topological characteristics. An open-source graph analysis software, igraph, is used to compute the closeness, eigenvector and betweenness centrality values for each network. The vulnerability index of each network is then calculated by using Equation (11). After computing the vulnerability index, this section compares the vulnerability of two case studies.

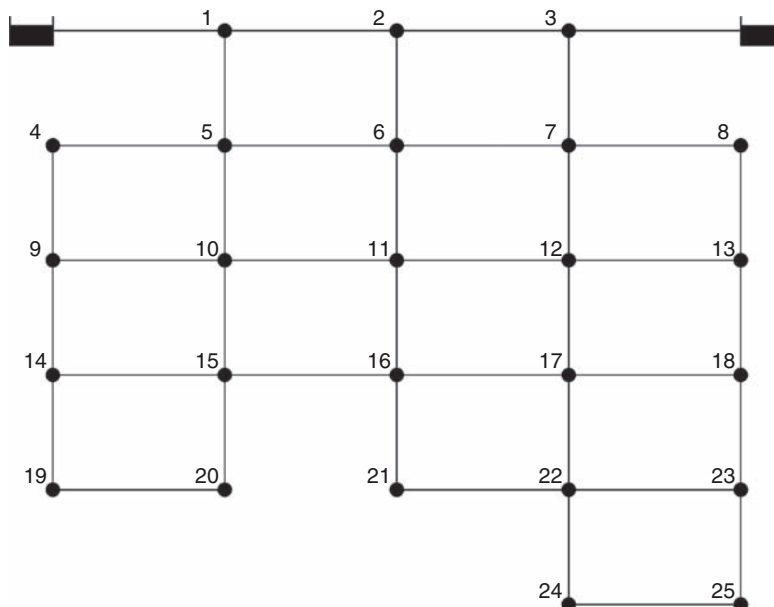
##### 4.1 Case Study 1

The first case study, as shown in Figure 1, is a looped WDN taken from the literature (Islam *et al.*, 2014; Shuang *et al.*, 2014b). As a means to illustrate the proposed vulnerability index, the case study is mapped into an undirected graph with a node set of size 27 and an edge set of size 40. Water is supplied from two reservoirs connected to nodes 1 and 3.

The values of betweenness, eigenvector and closeness centrality for all nodes using igraph software are now obtained. These values are presented in Table I. The gray columns report the ranking of each node based on its corresponding centrality score.

In order to provide better visualization of the results in Table I, the resulting rankings of the nodes are plotted in Figure 2.

As noted earlier,  $C_C$ ,  $C_E$  and  $C_B$  measure closeness, eigenvector and betweenness centrality importance score, respectively. As reported by Table I and Figure 2, betweenness centrality places nodes 16 and 11 at the first and the second positions, respectively. This is because these two nodes are centrally located in the network, thus when compared to other nodes, they participate in a higher number of shortest paths between any given pair of nodes.



**Figure 1.**  
Case Study 1: an  
example WDN from  
the literature

**Table I.**  
Numerical values of  
centrality metrics for  
the first case study

Node	$C_C$	Rank	$C_E$	Rank	$C_B$	Rank
1	0.2600	19	0.3775	18	0.0953	12
2	0.2796	14	0.4734	13	0.0833	13
3	0.2708	16	0.3856	17	0.0973	11
4	0.2549	20	0.3404	20	0.0201	23
5	0.3132	9	0.704	8	0.1796	9
6	0.3421	5	0.8519	3	0.1999	6
7	0.3291	7	0.7291	7	0.1884	8
8	0.2708	16	0.3622	19	0.0229	21
9	0.2737	15	0.4574	14	0.0560	18
10	0.3421	5	0.8323	5	0.1996	7
11	0.3768	1	1	1	0.2416	2
12	0.3611	2	0.8879	2	0.2176	4
13	0.2921	10	0.5066	10	0.0667	15
14	0.2653	18	0.388	16	0.0621	17
15	0.3291	7	0.6782	9	0.2127	5
16	0.3611	2	0.8397	4	0.2607	1
17	0.3467	4	0.7936	6	0.2299	3
18	0.2826	12	0.4785	12	0.0821	14
19	0.2149	24	0.1882	24	0.0033	25
20	0.2549	20	0.2539	22	0.0276	20
21	0.2921	10	0.3931	15	0.0546	19
22	0.2826	12	0.5015	11	0.1508	10
23	0.2385	22	0.3323	21	0.0622	16
24	0.2261	23	0.192	23	0.0217	22
25	0.1970	25	0.1534	25	0.0039	24

As expected, nodes 19 and 25 take on the lowest betweenness centrality values, indicating that these nodes play a role in very few shortest paths.

Using eigenvector centrality, node 11 is scored 1.00 and all other nodes have lower scores ranging downwards toward 0.1534. The highest value of  $C_E$  is for node 11 because the sum of the eigenvector centrality values of its immediate neighbors (nodes 6, 10, 12 and 16) is relatively high.

When closeness centrality is applied, the highest ranks are, respectively, attained for nodes 11 and 16 because the mean distance from each of these two nodes to all other nodes in the example network is relatively low. On the other side, closeness centrality places nodes 25 at the lowest position since the average farness of this node to all other nodes is high.

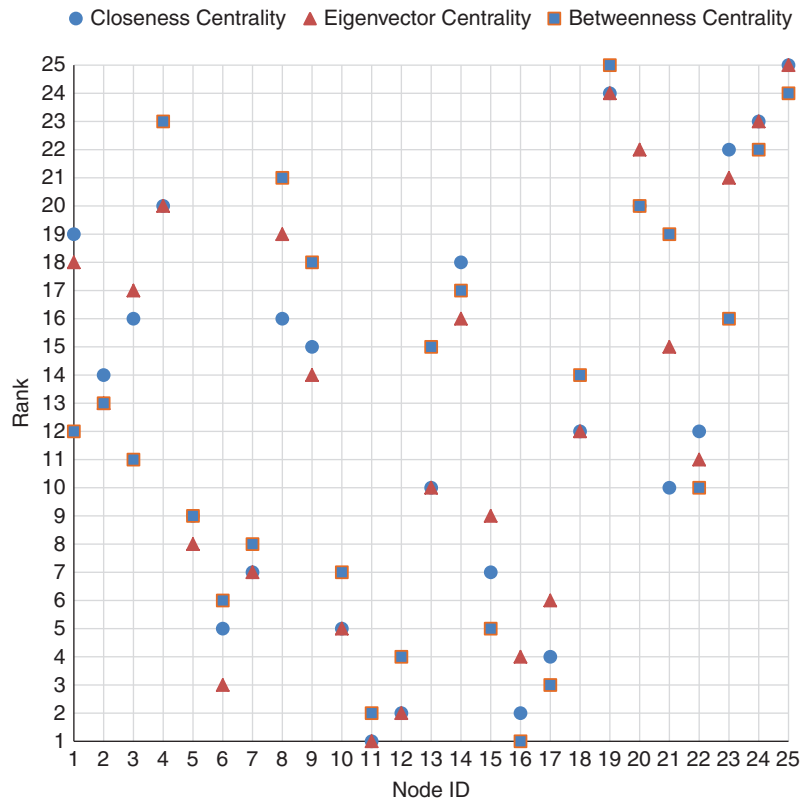
It can be observed that closeness and eigenvector centrality are equal on their impact on the ranking of the nodal elements. A slight difference between the rankings of nodal elements can be observed when closeness and eigenvector centrality are applied. For example, nodes 11, 12, 13, 18, 19, 24 and 25 have exactly the same rankings when these two centrality measures are used. Furthermore, the differences in the ranking of other nodes using closeness and eigenvector centrality are not conspicuous. This can be interpreted as the evidence that betweenness centrality differs from other centrality measures. A node can have no important neighbors or can be a long way from all other nodes on average, and still has a high betweenness score.

Up to this point, the importance of each node using various centrality measures has been assessed. It is now possible to calculate the vulnerability index described in Section 3.

Using Equation (11), the normalized centrality values are presented in Table II.

Using Equation (6), the entropy of the normalized centrality values obtained from Table II is:

$$H_{CC} = -4.6245, H_{CE} = -4.4888, H_{CB} = -4.2192.$$



**Figure 2.**  
Rankings of nodes for  
the first case study

By substituting the results into Equation (8):

$$H_{CT} = -13.3325.$$

Given  $m = 25$ , using Equation (10):

$$H_{CT, \max} = -3\log_2 25 = -13.9317.$$

By using Equation (11) and substituting the values of  $H_{CT}$ , and  $H_{CT, \max}$ :

$$VI = 0.0430.$$

As can be seen, the resulting vulnerability index for this case is rather low, which implies a relatively low risk to disruption of the service in the network. This can be ascribed to a highly homogenous distribution of the normalized centrality values. This result conforms to the intuition of the vulnerability concept because in this case study water can flow from source nodes to junction nodes through many pathways; as a result, the nodes have a comparable influence on the overall performance of the network.

#### 4.2 Case Study 2

The second case study is a real-world WDN of Price, a small town in South Australia, located 140 km west of Adelaide, Australia. The network is a directed tree-shaped WDN, represented

**Table II.**  
Normalized centrality  
values for the first  
case study

Node	$C_C$	$PC_C$	$C_E$	$PC_E$	$C_B$	$PC_B$
1	0.2600	0.0359	0.3775	0.0289	0.0953	0.0314
2	0.2796	0.0386	0.4734	0.0362	0.0833	0.0275
3	0.2708	0.0374	0.3856	0.0295	0.973	0.0321
4	0.2549	0.0352	0.3404	0.026	0.0201	0.0067
5	0.3132	0.0432	0.7040	0.0538	0.1796	0.0592
6	0.3421	0.0472	0.8519	0.0651	0.1999	0.0659
7	0.3291	0.0454	0.7291	0.0557	0.1884	0.0621
8	0.2708	0.0374	0.3622	0.0277	0.0229	0.0076
9	0.2737	0.0378	0.4574	0.035	0.0560	0.0185
10	0.3421	0.0472	0.8323	0.0636	0.1996	0.0658
11	0.3768	0.052	1.0000	0.0764	0.2416	0.0796
12	0.3611	0.0498	0.8879	0.0678	0.2176	0.0717
13	0.2921	0.0403	0.5066	0.0387	0.0667	0.022
14	0.2653	0.0366	0.3880	0.0297	0.0621	0.0205
15	0.3291	0.0454	0.6782	0.0518	0.2127	0.0701
16	0.3611	0.0498	0.8397	0.0641	0.2607	0.0859
17	0.3467	0.0478	0.7936	0.0606	0.2299	0.0758
18	0.2826	0.039	0.4785	0.0366	0.0821	0.0271
19	0.2149	0.0297	0.1882	0.0144	0.0033	0.0011
20	0.2549	0.0352	0.2539	0.0194	0.0276	0.0091
21	0.2921	0.0403	0.3931	0.0301	0.0546	0.018
22	0.2826	0.0390	0.5015	0.0383	0.1508	0.0497
23	0.2385	0.0329	0.3323	0.0254	0.0622	0.0205
24	0.2261	0.0312	0.1920	0.0147	0.0217	0.0715
25	0.1970	0.0272	0.1534	0.0118	0.0039	0.0013

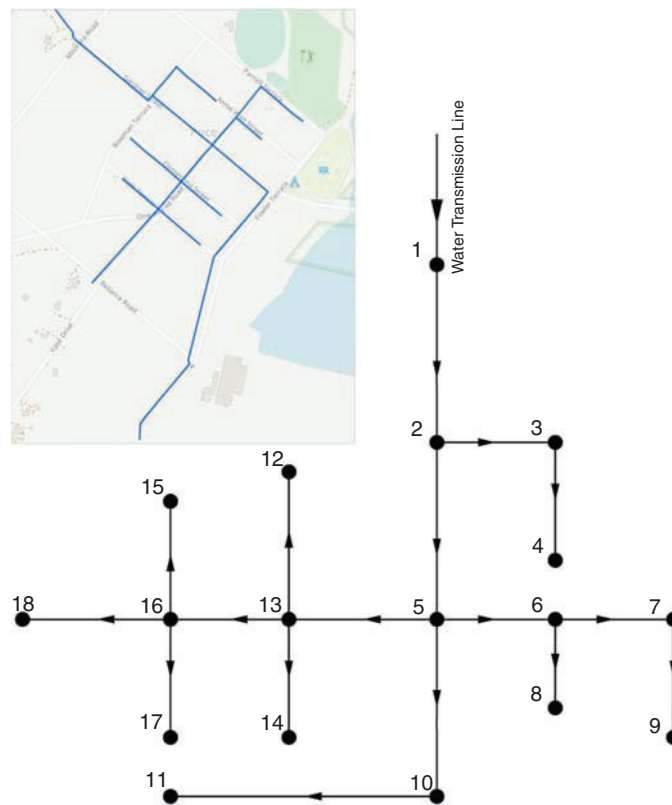
by 18 nodes connecting 17 pipes (Figure 3). The layout for this case study has been obtained from the official website of South Australia Water company (<http://sawater.maps.arcgis.com>).

Applying the same procedure as the previous case study, the values of betweenness, eigenvector and closeness centrality of nodes for the second case study are presented in Table III, where the gray columns report the ranking of each node based on its corresponding centrality score.

The resulting rankings of nodes for this case study are plotted in Figure 4.

Examination of Table III and Figure 4 reveals a high correlation between eigenvector and betweenness centrality for the tree-shaped case study. These two centrality measures identify nodes 2, 5, 6, 13 and 16 as the top 5 critical nodes. When betweenness centrality is applied, nodes 5 and 13 are, respectively, placed at the first and the second positions. In fact, these nodes are centrally located in the network, as such, a high number of shortest paths passes through them. Similarly, eigenvector centrality posits these two nodes at the exact same positions. This can be attributed to the importance of the immediate neighbors of these nodes. Using betweenness centrality, nodes 4, 8, 9, 11, 12, 14, 15, 17 and 18 take on the value of 0. In a similar vein, eigenvector centrality considers the lowest criticality for these nodes. The fact that these nodes play no role in any shortest paths as well as the relatively low value of the sum of the eigenvector centrality of their immediate neighbors make the results unsurprising.

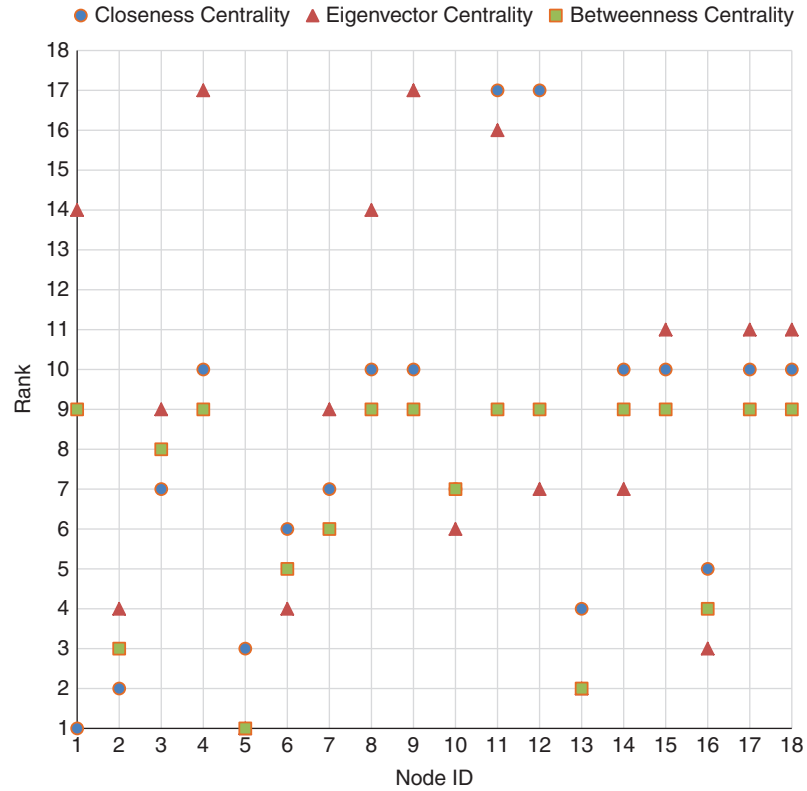
Using closeness centrality, node 1 turns out to be the most critical element, whereas nodes 11 and 12 are placed in the same position as the least critical nodes. This is because the closeness centrality of a junction node in a directed graph is defined by the inverse of the average length of shortest paths to/from all other nodes; therefore, unlike an undirected graph, the total number of nodes may not be used in Equation (1). Intuitively, the failure of node 1 leaves all other nodes without water supply, while the failure of nodes 11 or 12 does not affect other nodes in the network.



**Figure 3.**  
Case Study 2: price  
water distribution  
network

Node	$C_C$	Rank	$C_E$	Rank	$C_B$	Rank
1	0.2787	1	0.2275	14	0	9
2	0.2742	2	0.5834	4	0.0588	3
3	0.0588	7	0.2683	9	0.0074	8
4	0.0556	10	0.1046	17	0	9
5	0.1717	3	1	1	0.0956	1
6	0.0664	6	0.5834	4	0.0331	5
7	0.0588	7	0.2683	9	0.0147	6
8	0.0556	10	0.2275	14	0	9
9	0.0556	10	0.1046	17	0	9
10	0.0588	7	0.46	6	0.011	7
11	0.0555	17	0.1794	16	0	9
12	0.0555	17	0.3656	7	0	9
13	0.0821	4	0.9374	2	0.0662	2
14	0.0556	10	0.3656	7	0	9
15	0.0556	10	0.2622	11	0	9
16	0.0667	5	0.6724	3	0.0441	4
17	0.0556	10	0.2622	11	0	9
18	0.0556	10	0.2622	11	0	9

**Table III.**  
Numerical values of  
centrality metrics for  
the second case study



**Figure 4.**  
Rankings of nodes for  
the second case study

It is now possible to calculate the vulnerability index proposed in this work. Using Equation (5), the normalized centrality values for this case study are presented in Table IV.

Using Equation (6), the entropy of the normalized centrality values obtained from Table IV is:

$$H_{CC} = -3.8387, H_{CE} = -3.8989, H_{CB} = -2.6301.$$

By substituting the results into Equation (8):

$$H_{CT} = -10.3677.$$

Given  $m = 18$ , using Equation (10):

$$H_{CT, \max} = -3\log_2 18 = -12.5098.$$

By using Equation (11) and substituting the values of  $H_{CT}$ , and  $H_{CT, \max}$ :

$$VI = 0.1712.$$

The high value of VI in this case study describes how significant the likely consequences of failures may be. This can be interpreted as the evidence that due to the heterogeneous distribution of the nodal centralities in this case study, failure of a highly central node (e.g. node 5) leads to a significant loss of the performance in the network.

Node	$C_C$	$PC_C$	$C_E$	$PC_E$	$C_B$	$PC_B$	Topological vulnerability analysis of WDNs
1	0.2787	0.1724	0.2275	0.0319	0	0	
2	0.2742	0.1696	0.5834	0.0818	0.0588	0.1777	
3	0.0588	0.0364	0.2683	0.0376	0.0074	0.0224	
4	0.0556	0.0344	0.1046	0.0147	0	0	
5	0.1717	0.1062	1.0000	0.1402	0.0956	0.2889	
6	0.0664	0.0411	0.5834	0.0818	0.0331	0.1000	
7	0.0588	0.0364	0.2683	0.0376	0.0147	0.0342	
8	0.0556	0.0344	0.2275	0.0319	0	0	
9	0.0556	0.0344	0.1046	0.0147	0	0	
10	0.0588	0.0364	0.4600	0.0645	0.0110	0.0332	
11	0.0555	0.0344	0.1794	0.0251	0	0	
12	0.0555	0.0344	0.3656	0.0512	0	0	
13	0.0821	0.0508	0.9374	0.1314	0.0662	0.2000	
14	0.0556	0.0344	0.3656	0.0512	0	0	
15	0.0556	0.0344	0.2622	0.0368	0	0	
16	0.0667	0.0413	0.6724	0.0942	0.0441	0.1333	
17	0.0556	0.0344	0.2622	0.0368	0	0	
18	0.0556	0.0344	0.2622	0.0368	0	0	

**Table IV.**  
Normalized centrality  
values for the second  
case study

#### 4.3 Comparison of results

The previous discussions reveal the relationships between closeness, eigenvector and betweenness centrality in assessing the importance of nodes within two contrasting case studies. Overall, the results show a positive correlation between all centrality measures. Correlation between closeness and eigenvector centrality is more evident in the strongly looped layout, whereas the tree-shaped case study exhibits a relatively high correlation between eigenvector and betweenness centrality. However, despite the similarity in concept, the strict linear relationships in any of the cases are not observed. For example, closeness centrality does not convey the same information for two case studies. In the looped network, closeness centrality counts the total number of nodes for measuring the mean distance from a node to other nodes, while in the tree-shaped network, it does not use the total number of nodes and distinguishes between upstream and downstream nodes.

What is particularly striking about the contrast between vulnerability indices generated for two case studies is that the first case study presents a rather homogeneous distribution of the nodal centralities, whereas the second case study produces a highly heterogeneous distribution of the centrality values. The resulting vulnerability index in the first case study is therefore far lesser than that of the second case study. This proves that the proposed vulnerability index captures the distinctions between the tree-shaped networks, where water can take only one pathway from the source to the households, and the looped WDNs, where water flows from the source node to the households through many pathways. In fact, VI measures the risk to the satisfactory level of water supply service. The larger the vulnerability index, the larger magnitude of the failure, as such the consequences of disruptive events on the network performance in the second case study have been precisely captured by a higher vulnerability index when compared to the first case study.

## 5. Conclusion

The methods presently used for vulnerability analysis of WDNs have lagged far behind capturing various topological attributes of these networks. The existing literature on this problem captures very generic topological features of WDNs and analyzes the vulnerability in a local sense. The present paper, first, evaluates the degree of influence of a node by employing graph theory quantities known as closeness, eigenvector and betweenness centrality.

This work then extends the vulnerability analysis further to the global level by generating a new vulnerability index. The new index is developed from the information entropy based on the distribution of the normalized centrality values.

Using two case studies, a tree-shaped WDN and a looped network from the literature, this paper has demonstrated the effectiveness of the proposed method. As the previous discussion attests, the proposed vulnerability analysis method is consistent with the intuitive notion of vulnerability and is capable of capturing the distinctions between various layouts of WDNs.

This work provides two types of practical implications. First, the maintenance strategy based on the vulnerability assessment model proposed in this work enables water service providers to rank and prioritize the deteriorating pipes. This, in turn, allows for least cost decisions to make for renewal and rehabilitation of pipeline assets. Second, the global vulnerability analysis, proposed in this work, provides water utilities with the opportunity to determine the consequences of unexpected events on the overall performance of the network. This can be used to establish a risk management plan that deals with prevention, decision-making, action taking, crisis management and recovery.

This paper contributes to vulnerability analysis of WDNs by generating new knowledge in the area of vulnerability analysis through coupling the centrality analysis and the entropy theory. However, the conventional centrality measures rely only on the topological information. Therefore, these measures only partially describe a network structure and cannot entirely characterize its properties. Further research might seek to develop a domain specific centrality metrics by taking into account the topological along with the hydraulic attributes of the nodes in the network.

#### References

- Bavelas, A. (1950), "Communication patterns in task-oriented groups", *The Journal of Acoustical Society of America*, Vol. 22 No. 6, pp. 725-730.
- Boldi, P. and Vigna, S. (2013), "Axioms for centrality", *Internet Mathematics*, Vol. 10 Nos 3-4, pp. 222-262.
- Brandes, U., Kenis, P. and Wagner, D. (1999), "Centrality in policy network drawings extended abstract", *Lecture Notes in Computer Science*, Vol. 1731, pp. 250-258.
- Cadini, F., Zio, E. and Petrescu, A. (2009), "Using centrality measures to rank the importance of the components of a complex network infrastructure", *Lecture Notes in Computer Science*, Vol. 5508, pp. 155-167.
- Di Nardo, A. and Di Natale, M. (2011), "A heuristic design support methodology based on graph theory for district metering of water supply networks", *Engineering Optimization*, Vol. 43 No. 2, pp. 193-211.
- Fragiadakis, M. and Christodoulou, S.E. (2014), "Seismic reliability assessment of urban water networks", *Engineering & Structural Dynamics*, Vol. 43 No. 3, pp. 357-374.
- Fragiadakis, M., Xanthos, S., Eliades, D.G., Gagatsis, A. and Christodoulou, S.E. (2016), "Graph-based hydraulic vulnerability assessment of water distribution networks", *Lecture Notes in Computer Science Engineering & Structural Dynamics*, Vol. 8985, pp. 81-87.
- Gunawan, I., Schultmann, F. and Zarghami, S.A. (2017), "The four Rs performance indicators of water distribution networks: a review of research literature", *International Journal of Quality & Reliability Management*, Vol. 34 No. 5, pp. 720-732.
- Islam, M.S., Sadiq, R., Rodriguez, M.J., Najjaran, H. and Hoorfar, M. (2014), "Reliability assessment for water supply systems under uncertainties", *Journal of Water Resources Planning and Management*, Vol. 140 No. 4, pp. 468-476.
- Joyce, K., Laurienti, P.J., Burdette, J.H. and Hayasaka, S. (2010), "A new measure of centrality for brain networks", *PLoS One*, Vol. 5 No. 8, pp. 1-13.



- 
- Laucelli, P. and Giustolisi, O. (2015), "Vulnerability assessment of water distribution networks under seismic actions", *Journal of Water Resources Planning and Management*, Vol. 141 No. 6, pp. 1-13.
- Lozares, C., Lopez-Roldan, P., Bolibar, M. and Montanyola, D. (2015), "The structure of global centrality measures", *International Journal of Social Research Methodology*, Vol. 18 No. 2, pp. 209-226.
- Maszczyk, T. and Duch, W. (2008), "Comparison of Shannon, Renyi and Tsallis entropy used in decision trees", *Lecture Note in Computer Science*, Vol. 5097, pp. 643-651.
- Perelman, L. and Ostfeld, A. (2011), "Topological clustering for water distribution systems analysis", *Environmental Modelling & Software*, Vol. 26 No. 7, pp. 969-972.
- Qi, X., Fuller, E., Wu, Q., Wu, Y. and Zhang, C.Q. (2012), "Laplacian centrality: a new centrality measure for weighted networks", *Information Sciences*, Vol. 194, pp. 240-253.
- Shannon, C.E. (1948), "A mathematical theory of communication", *Bell System Technical Journal*, Vol. 27 No. 3, pp. 379-423.
- Sheng, N., Jia, Y., Xu, Z., Ho, S.L. and Kan, C.W. (2013), "A complex network based model for detecting isolated communities in water distribution networks", *Chaos: An Interdisciplinary Journal of Nonlinear Science*, Vol. 23 No. 4, pp. 1-10.
- Shuang, Q., Zhang, M. and Yuan, Y. (2014a), "Performance and reliability analysis of water distribution systems under cascading failures and the identification of crucial pipes", *PLoS One*, Vol. 9 No. 2, pp. 1-11.
- Shuang, Q., Zhang, M. and Yuan, Y. (2014b), "Node vulnerability of water distribution networks under cascading failures", *Reliability Engineering and System Safety*, Vol. 124, pp. 132-141.
- Shuang, Q., Yuan, Y., Zhang, M. and Liu, Y. (2015), "A cascade-based emergency model for water distribution networks", *Mathematical Problems in Engineering*, Vol. 2015, pp. 1-11.
- Singh, V.P. (2013), *Entropy Theory and its Application in Environmental and Water Engineering*, Wiley-Blackwell, New York, NY.
- Yazdani, A. and Jeffrey, P. (2011), "Complex network analysis of water distribution systems", *Chaos: An Interdisciplinary Journal of Nonlinear Science*, Vol. 21 No. 1, pp. 1-10.
- Yazdani, A. and Jeffrey, P. (2012), "Applying network theory to quantify the redundancy and structural robustness of water distribution systems", *Journal of Water Resources Planning and Management*, Vol. 138 No. 2, pp. 153-161.
- Yazdani, A., Otoo, R.A. and Jeffrey, P. (2011), "Resilience enhancing expansion strategies for water distribution systems: a network theory approach", *Environmental Modelling and Software*, Vol. 26 No. 12, pp. 1574-1582.
- Zamenian, H., Choi, T. and Sadeghi, S.A. (2017), "Systematic approach for asset management of urban water pipeline infrastructure systems", *Built Environment Project and Asset Management*, Vol. 7 No. 5, pp. 506-5017.
- Zarghami, S.A., Gunawan, I. and Schultmann, F. (2018), "Integrating entropy theory and cospanning tree technique for redundancy analysis of water distribution networks", *Reliability Engineering and System Safety*, Vol. 176, pp. 102-112.
- Zhuang, B., Lansley, K. and Kang, D. (2013), "Resilience/availability analysis of municipal water distribution system incorporating adaptive pump operation", *Journal of Hydraulic Engineering*, Vol. 139 No. 5, pp. 527-538.

#### Further reading

SA Water (2018), "Water main replacement program", available at: <http://sawater.maps.arcgis.com/apps/View/index.html?appid=afdd0293e7834256beb889b205f8b830> (accessed January 18, 2018).

#### Corresponding author

Seyed Ashkan Zarghami can be contacted at: [ashkan.zarghami@adelaide.edu.au](mailto:ashkan.zarghami@adelaide.edu.au)

---

For instructions on how to order reprints of this article, please visit our website:

[www.emeraldgroupublishing.com/licensing/reprints.htm](http://www.emeraldgroupublishing.com/licensing/reprints.htm)

Or contact us for further details: [permissions@emeraldinsight.com](mailto:permissions@emeraldinsight.com)

# *Chapter 6*

## Coupling Probabilistic and Importance-Based Reliability Analysis

## 6. Coupling Probabilistic and Importance-Based Reliability Analysis

### 6.1. Paper 6: A fuzzy-based vulnerability assessment model for infrastructure networks incorporating reliability and centrality

## Statement of Authorship

Title of Paper	A fuzzy-based vulnerability assessment model for infrastructure networks incorporating reliability and centrality
Publication Status	<input type="checkbox"/> Published <input type="checkbox"/> Accepted for Publication <input checked="" type="checkbox"/> Submitted for Publication <input type="checkbox"/> Unpublished and Unsubmitted work written in manuscript style
Publication Details	Zarghami S.A., and Gunawan, I. (2018). A fuzzy-based vulnerability assessment model for infrastructure networks incorporating reliability and centrality. <i>Engineering, Construction and Architectural Management</i> . Under Review.

### Principal Author

Name of Principal Author (Candidate)	Seyed Ashkan Zarghami		
Contribution to the Paper	Design the model and computational framework- Developing the theory- Proposing a new method- Performing the analytic calculations- Demonstrating the proposed method on case studies-Discussion of results- Identifying avenues for future work- Writing the manuscript		
Overall percentage (%)	85%		
Certification:	This paper reports on original research I conducted during the period of my Higher Degree by Research candidature and is not subject to any obligations or contractual agreements with a third party that would constrain its inclusion in this thesis. I am the primary author of this paper.		
Signature		Date	02/05/19

### Co-Author Contributions

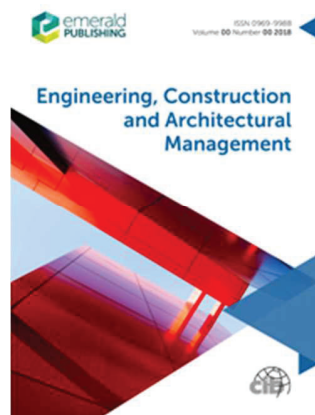
By signing the Statement of Authorship, each author certifies that:

- i. the candidate's stated contribution to the publication is accurate (as detailed above);
- ii. permission is granted for the candidate to include the publication in the thesis; and
- iii. the sum of all co-author contributions is equal to 100% less the candidate's stated contribution.

Name of Co-Author	Associate Professor Indra Gunawan		
Contribution to the Paper	Supervising development of the work- Verifying the numerical results- Evaluation of the manuscript- Helping to edit the manuscript-Final approval of the version to be published		
Signature		Date	2/5/19

Name of Co-Author			
Contribution to the Paper			
Signature		Date	

Please cut and paste additional co-author panels here as required.



**A fuzzy-based vulnerability assessment model for infrastructure networks incorporating reliability and centrality**

Journal:	<i>Engineering, Construction and Architectural Management</i>
Manuscript ID	Draft
Manuscript Type:	Original Article
Keywords:	Risk Management, Novel Model, Engineering
Abstract:	

SCHOLARONE™  
Manuscripts

## **A fuzzy-based vulnerability assessment model for infrastructure networks incorporating reliability and centrality**

### ***Abstract***

**Purpose-** This paper attempts to shift away from an exclusive probabilistic viewpoint or a pure network theory-based perspective for vulnerability assessment of Infrastructure Networks (INs), towards an integrated framework that accounts for joint considerations of the consequences of a component failure as well as the component reliability.

**Design/methodology/approach-** This work introduces a Fuzzy Inference System (FIS) model that deals with the problem of vulnerability analysis by mapping reliability and centrality to vulnerability. In the presented model, reliability and centrality are first fuzzified, then sixteen different rules are defined and finally, a defuzzification process is conducted to obtain the model output, termed the vulnerability score. The FIS model developed herein attempts to explain the linkage between reliability and centrality so as to evaluate the degree of vulnerability for INs elements.

**Findings-** This article compared the effectiveness of the vulnerability score in criticality ranking of the components against the conventional vulnerability analysis methods. Comparison of the output of the proposed FIS model with the conventional vulnerability indices reveals the effectiveness of the vulnerability score in identifying the criticality of components. The model result showed the vulnerability score decreases by increasing reliability and decreasing centrality.

**Practical implications-** Two key practical implications for vulnerability analysis of INs can be drawn from the suggested FIS model in this research. First, the maintenance strategy based on the vulnerability analysis proposed herein will

1  
2  
3 provide an expert facilitator that helps infrastructure utilities to identify and prioritize  
4 the vulnerabilities. The second practical implication is especially valuable for  
5 designing an effective risk management framework, which allows for least cost  
6 decisions to be made for the protection of INs.  
7  
8  
9  
10

11  
12 **Originality/value-** As part of the first contribution, we propose a novel fuzzy-based  
13 vulnerability assessment model in building a qualitative and quantitative picture of  
14 the vulnerability of INs. The second contribution is especially valuable for  
15 vulnerability analysis of INs by virtue of offering a key to understanding the  
16 component vulnerability principle as being constituted by the component likely  
17 behavior as well as the component importance in the network.  
18  
19  
20  
21  
22  
23  
24

25 *Keywords:* Centrality; Fuzzy inference system; Infrastructure networks; Reliability;  
26 Vulnerability.  
27  
28  
29  
30

## 31 **1. Introduction**

32  
33

34 Infrastructure Networks (INs) are inextricably linked to different aspects of human  
35 life such as safety, security, economy, public health and social well-being. The term  
36 “Infrastructure Networks” generally refers to lifeline systems such as transportation,  
37 power, water and gas networks. As a general rule, the more developed and reliable  
38 INs in a country, the better the living standards. However, INs are exposed to a  
39 myriad of operational threats that lead to disruption and dysfunction of their  
40 performance. The concept of a network vulnerability is related to the potential for  
41 disrupting the network components and degrading them in such a way that affects the  
42 overall performance of the network (Murray and Grubestic, 2007). The complex  
43 nature of INs provides the conditions for which disruption of critical components  
44  
45  
46  
47  
48  
49  
50  
51  
52  
53  
54  
55  
56  
57  
58  
59  
60

1  
2  
3 propagates in numerous ways, resulting in an unforeseen and cumulative impact on  
4  
5 the network failure (Thacker *et al.*, 2017). Such complexity reinforces the need to  
6  
7 implement an efficient and effective vulnerability assessment model in order to  
8  
9 protect these lifeline systems.  
10

11  
12 In the existing literature, researchers have developed two rather different approaches  
13  
14 to assess the vulnerability of INs to a disruption: (i) probabilistic-based methods from  
15  
16 the reliability theory, (ii) network theory-based methods as deterministic measures of  
17  
18 vulnerability (Boesch *et al.*, 2009; Nicholson *et al.*, 2016).  
19  
20

### 21 ***1.1. Probabilistic-based vulnerability analysis***

22  
23 The probabilistic-based vulnerability analysis has become a premier approach to  
24  
25 assess the vulnerability of INs. In this approach, the vulnerability is mainly evaluated  
26  
27 along with the network reliability. As a result, much effort has been devoted to  
28  
29 analyzing the reliability of INs as a proxy to evaluate the vulnerability. There already  
30  
31 exist several innovative methods to assess the reliability of networks, but the  
32  
33 underlying principle of all is the same. These methods are embedded in capturing a  
34  
35 picture of a system's likely behavior (Johansson *et al.*, 2013). In this sense, the likely  
36  
37 behavior of a system is quantified by calculating different probabilities drawing on  
38  
39 different interpretations of the vulnerability. Zhang *et al.* (2011) developed a holistic  
40  
41 method for vulnerability analysis of a transportation infrastructure by measuring the  
42  
43 average reliability between every pair of nodes in the network. Wang *et al.* (2011)  
44  
45 suggested a probabilistic region failure model for vulnerability evaluation of  
46  
47 networks based on the failure of a link with certain probability taking into account its  
48  
49 distance to the failure center. Fragiadakis and Christodoulou (2014) assessed the  
50  
51 vulnerability of water networks by conducting survival analysis based on the failure  
52  
53  
54  
55  
56  
57  
58  
59  
60

1  
2  
3 probability of the pipes. Praks *et al.* (2015) proposed a probabilistic model for  
4 vulnerability analysis of gas networks based on the reliability of supply at each  
5 consuming node. Shuang *et al.* (2017) identified the vulnerable pipes in water  
6 distribution networks by evaluation of system reliability and failure propagation  
7 time.  
8  
9

### 10 11 12 13 14 15 **1.2. Network theory-based vulnerability analysis**

16  
17 In recent times, a number of researchers have adopted graph invariants (e.g.,  
18 centrality, degree, diameter, clustering coefficient) as deterministic measures of  
19 vulnerability. Such studies approach the vulnerability of an IN based on the  
20 importance of its component. On contrary to the probabilistic-based approach, the  
21 network theory-based approach does not address the probabilities or frequencies of  
22 the system partial failures. The focus of the outcomes of this approach is on the  
23 interconnections between network elements rather than on the elements themselves  
24 (Joyce *et al.*, 2010). This approach is mainly concerned with the components  
25 importance as well as the consequences of component failures rather than the  
26 reliability of components. Holmgren (2006) posited the graph theory as a tool to  
27 analyze the vulnerability of electric power networks. Jönsson *et al.* (2008)  
28 determined the consequences of component failures in an electric power system in  
29 order to evaluate the vulnerability of the system. Ouyang (2016) suggested a  
30 vulnerability analysis method based on the identification of the critical locations  
31 where failures of INs components occur and then analyzed the induced system-level  
32 vulnerability. There is also a growing body of literature emphasizing the  
33 vulnerability of networks by performing centrality analysis. The centrality analysis  
34 refers to measuring the extent to which a component is central to a network.  
35  
36  
37  
38  
39  
40  
41  
42  
43  
44  
45  
46  
47  
48  
49  
50  
51  
52  
53  
54  
55  
56  
57  
58  
59  
60



Hernandez-Fajardo and Dueñas-Osorio (2013) used the nodal betweenness centrality for vulnerability assessment of lifeline systems. Yazdani and Jeffrey (2012) developed a domain-specific centrality metric for vulnerability analysis of water distribution systems. The work of Alipour *et al.* (2014) analyzed the vulnerability of power transmission networks by adopting centrality measures in order to identify critical points across the network. Zarghami *et al.* (2018a) quantified the vulnerability of water distribution networks by integrating centrality analysis and informational entropy.

A pertinent question is then should the vulnerability of an IN be assessed according to the reliability of its components or instead should it be evaluated based on the consequences of its components failure. On the one hand, a component failure may be statistically unlikely due to its high reliability but the consequences of failure on the network may be sufficiently large to pose major issues (Taylor *et al.*, 2006). On the other hand, stand-alone use of the network-based approach yields insufficient information with respect to the likelihoods of different components becoming inoperable (Bloomfield *et al.*, 2017). On this premise, we advocate the idea that vulnerability analysis of INs should shift away from an exclusive probabilistic viewpoint or a pure network theory-based perspective, towards an integrated framework that accounts for joint considerations of the consequences of a component failure as well as the component reliability.

Accordingly, we argue that a different approach coupling the probabilistic-based and the network-based techniques seems a more effective method for vulnerability assessment. For what concerns the coupling of these two approaches, an intelligent system that can respond efficiently to data inputs appears to be available through the

1  
2  
3 Fuzzy Inference System (FIS). A FIS shows outstanding results when the model  
4 inputs cannot be combined with the existing quantitative methods due to their  
5 disparate natures. Two additional attributes have made the FIS particularly appealing  
6 to us. First, A FIS is a potent tool for modeling nonlinear systems such as INs, which  
7 allows for formalizing the knowledge of experts (Kluska, 2009). Second, a FIS has  
8 the capability to express the behavior of the system in an understandable way  
9 (Casillas *et al.*, 2003). In this study, the task of the proposed FIS model is combining  
10 two concepts: reliability, as a measure of a component likely behavior, and centrality,  
11 as a measure of a component importance, by defining fuzzy rules in order to produce  
12 a vulnerability score, as the output parameter. In a nutshell, the FIS model developed  
13 herein attempts to explain the linkage between reliability and centrality so as to  
14 evaluate the degree of vulnerability for INs elements.  
15  
16  
17  
18  
19  
20  
21  
22  
23  
24  
25  
26  
27  
28

29 As part of the first contribution, we propose a novel fuzzy-based vulnerability  
30 assessment model in building a qualitative and quantitative picture of the  
31 vulnerability of INs. The second contribution is especially valuable for vulnerability  
32 analysis of INs by virtue of offering a key to understanding the component  
33 vulnerability principle as being constituted by the component likely behavior as well  
34 as the component importance in the network.  
35  
36  
37  
38  
39  
40  
41  
42

43 In the next section, we recall the notion of centrality and outline some basic facts  
44 about the betweenness centrality, which is used as a measure of centrality in this  
45 research. We summarize some fundamentals of fuzzy theory in Section 3. In Section  
46 4, we present an example water distribution network from the literature that is used  
47 for the further elaboration of the proposed FIS. Section 5 is devoted to a discussion  
48  
49  
50  
51  
52  
53  
54  
55  
56  
57  
58  
59  
60

of the results obtained from the proposed method. The paper is concluded in Section 6 and possible avenues for future work are outlined in the end.

## 2. Centrality analysis

A complex network is characterized by a network of multiple interconnected interacting components, in which each component has a different level of impact on the dynamics of the network. A complex network is specified not only by its individual components' function but also by the characteristic influence of each component on its behavior. This situation raises questions such as 'How to identify a network's most influential components?', 'To what extent a particular component affects the network performance?' 'Which components have more central role than others?'. Centrality analysis was created in the late 1940s to answer these questions. After more than six decades, the idea of centrality is still alive and is being mobilized in an ever-widening range of applications (Freeman, 1978).

Centrality analysis aims to highlight the importance of network components pertaining to a given network performance (Zarghami *et al.*, 2018b). In the context of INs, centrality analysis has garnered much attention in the research literature. As such, much effort has been devoted to devising a number of centrality measures in order to evaluate the importance of components. While different centrality measures serve different purposes, the implicit starting point for all of them is the same. The intuitive conception of different centrality measures is based upon one of the following structural attributes of the components (Boldi and Vigna, 2013).

- 1) The component with the largest direct connections to other components.

- 2) The degree to which the component is close to all other components in the network.
- 3) The frequency with which a component falls between pairs of other components.
- 4) The largest number of incoming paths of length  $k$  to the component.
- 5) The component that maximizes the dominant eigenvector of the graph matrix.
- 6) The component with the highest probability in the stationary distribution of the natural random walk on the graph.

In this work, we identify the centrality of a network's elements by adopting the betweenness centrality, which is the most widely used centrality measure. Betweenness centrality sets the basis for the development of many other mathematically related measures (Lozares *et al.*, 2015). Let us briefly recall some basic facts about this centrality measure.

Betweenness centrality is based on the philosophy that a given node is central if it lies between many other nodes (Cadini *et al.*, 2009). Betweenness centrality of node  $i$ ,  $C_B(i)$ , is defined as the number of shortest paths between pairs of nodes that pass through this node. It can be stated in a non-normalized form as given below.

$$C_B(i) = \sum_{s \neq r \neq v} \frac{n_{s,r}(i)}{n_{s,r}} \quad (1)$$

where  $n_{s,r}(i)$  denotes the number of shortest paths between  $s$  and  $r$  passing through  $i$  and  $n_{s,r}$  represents the number of shortest paths between  $s$  and  $r$ .  $C_B(i)$  takes on values between 0 and 1 and attains its maximum value when node  $i$  falls on all shortest paths between two nodes.

Betweenness measures the extent to which a node is directly connected only to those other nodes that are not directly connected to each other (Monge and Contractor

2003). It is, in fact, a measure of the degree to which a node serves as a bridge. Betweenness centrality is a medial centrality measure that accounts for the relationship between a node to a pair of nodes rather than the relationship between a node to node (Bell, 2014). It successfully evaluates the impact of each node on the network performance and provides a numerical indicator to identify the network's most influential components (Lawyer, 2015).

### 3. Fuzzy set theory

This section is meant to account for the basic definitions of the fuzzy set theory. It also presents the concept of fuzzy logic followed by a discussion of different steps in a FIS development.

#### 3.1. Preliminary definitions

*A crisp value* has a precise value and is normally used in contrast with a fuzzy value, which is imprecise.

*A universe of discourse* is a set of all feasible or relevant elements with regard to a fuzzy concept.

*A membership function* of element  $x$  in a set  $A$  is represented by  $\mu_A(x)$ , which expresses the concept of belonging to a set  $A$ . It defines how each element of the universe of discourse is mapped to a membership value in  $[0,1]$  interval.

*A fuzzy set*  $\tilde{A}$  is defined as:  $\tilde{A} = \{(x, \mu_{\tilde{A}}(x)) | x \in X\}$ , where  $X$  represents the universe of discourse and  $\mu_{\tilde{A}}(x)$  denotes the grade of membership of  $x$  in  $X$ .

#### 3.2. Concept

1  
2  
3 Zadeh (1965) in his seminal paper, *Fuzzy Sets*, introduced a novel type of  
4 information and uncertainty, arising from human thinking, reasoning, and cognition.  
5

6  
7 Through this paper, Zadeh established a new mathematical tool for the formulation of  
8 the qualitative type of uncertainty (Gupta, 2011) and expressed the membership of a  
9 system's components to a specific class. Since the inception of fuzzy set theory in  
10 1965, it has provided fruitful solutions to a wide range of practical problems, to  
11 which conventional control algorithms are difficult to be applied. The concept of FIS,  
12 proposed in this work, is illustrated in Fig. 1.  
13  
14  
15  
16  
17  
18  
19  
20

21 **Fig.1.** Schematic chart of the fuzzy logic process

22 [Near here]  
23  
24  
25  
26

27 As can be seen in Fig. 1, the structure of a FIS is composed of three consecutive  
28 steps: fuzzification, fuzzy inference, and defuzzification. The first step in a FIS is  
29 fuzzification, involving two processes. First, constructing membership functions for  
30 input and output variables. Second, using the concept of linguistic variables, as non-  
31 numerical variables, to represent the variables in the system. The main rationale for  
32 using the linguistic variables is that these variables are more similar to the way that  
33 humans express and use their knowledge. In a standard fuzzy logic, a fuzzy set is  
34 represented by a continuous membership function, within which each element of the  
35 universe of discourse belongs to a fuzzy set with a certain degree in the real interval  
36 [0,1]. A high membership degree is assigned to the instance close to the class center  
37 and a low membership degree is attributed to the instance close to the boundaries  
38 (Ezghari *et al.*, 2017).  
39  
40  
41  
42  
43  
44  
45  
46  
47  
48  
49  
50  
51  
52  
53  
54  
55  
56  
57  
58  
59  
60

The second step of a FIS is a knowledge-based process incorporating a database and a set of rules. A fuzzy rule is expressed as a linguistic rule in the form of 'IF-THEN'.

The IF part captures knowledge by using the elastic conditions, and the THEN part is used to give the output in a linguistic variable form (Bai and Wang, 2006). In the case of multiple inputs, AND and OR operators are used to combine inputs in the IF part. Using AND operator accounts for the intersection of inputs, whereas OR operator implies the union of inputs. Fuzzy rules are then processed using fuzzy inference methods. Two most commonly-used inference methods are Mamdani fuzzy inference method and Takagi-Sugeno fuzzy inference technique. The main differences between these two methods reside in the consequence of fuzzy rules.

In the Mamdani fuzzy inference method, the consequents in the base of rules are calculated by adopting the minimum membership value for the logic connective "AND", using Eq. (2), whereas for the logic connective "OR" the maximum membership value, Eq. (3) is used (Pourjavad and Shahin, 2018).

$$\mu_A(x) \text{ AND } \mu_B(x) = \text{MIN}\{\mu_A(x), \mu_B(x)\} \quad (2)$$

$$\mu_A(x) \text{ OR } \mu_B(x) = \text{MAX}\{\mu_A(x), \mu_B(x)\} \quad (3)$$

Takagi-Sugeno fuzzy inference technique changes the THEN part of the Mamdani method with a function of the input variables. It uses a linear combination of the inputs, while the Mamdani method employs the technique of defuzzification of a fuzzy output (Cavallaro, 2015). A typical form of the Takagi-Sugeno method can be expressed as follows:

*IF antecedent 1 is x AND antecedent 2 is y THEN consequent z is  $ax + by + c$*

1  
2  
3 In a FIS, each rule whose antecedent has a non-zero matching degree will contribute  
4 an output (Pham and Castellani, 2002). Since decisions are made based on the output  
5 of all rules, these outputs should be aggregated. In the aggregation process, the  
6 output of each rule is combined into a single fuzzy set using different operators such  
7 as arithmetic, Min, Max and geometric.  
8  
9

10  
11 As shown in Fig. 1, defuzzification is the final step of a FIS. The conclusion or  
12 control output generated in the previous step is still a linguistic variable, which is a  
13 vague or fuzzy element. Defuzzification is applied to transform this linguistic  
14 variable into a crisp variable in order to make it available to real applications (Bai  
15 and Wang, 2006). More specifically, defuzzification of a fuzzy quantity converts it to  
16 a precise quantity, just as fuzzification of a precise quantity transposes it to a fuzzy  
17 quantity (Ross, 2017). Three most commonly used defuzzification techniques are  
18 Mean of Maximum method, Center of Gravity method and Height method. In this  
19 paper, in order to transpose the fuzzy outputs to a crisp output (vulnerability score),  
20 the Center of Gravity (COG) method, which is the most prevalent and physically  
21 appealing of all defuzzification method (Ross, 2017), is utilized. In this method, the  
22 crisp values are calculated as:  
23  
24  
25  
26  
27  
28  
29  
30  
31  
32  
33  
34  
35  
36  
37  
38  
39

$$x^* = \frac{\int \mu_i(x) \cdot x dx}{\int \mu_i(x) dx} \quad (4)$$

40  
41 where  $x^*$  is defuzzified result,  $\mu_i(x)$  represents the membership function and  $x$  is the  
42 value of a linguistic variable.  
43  
44  
45  
46  
47  
48  
49  
50

#### 51 **4. Application**

52  
53  
54  
55  
56  
57  
58  
59  
60



1  
2  
3 As discussed in the introduction section, the overarching aim of this study is to  
4 develop a fuzzy-based vulnerability assessment model obtained from integration of  
5 the reliability and centrality values. To demonstrate the process of the FIS described  
6 in the preceding section, a water distribution network (as an example of INs), as  
7 shown in Fig. 2, taken from the literature (Islam *et al.*, 2014; Shuang *et al.*, 2014;  
8 Shuang *et al.*, 2017) is used as a case study. The network is a looped water  
9 distribution network comprising 25 sink nodes connected by 38 pipes. Water is  
10 supplied from two reservoirs connected to nodes 1 and 3. The example network is  
11 first mapped into an undirected graph with 25 nodes and 38 edges. The reliability of  
12 edges is displayed in parentheses.  
13  
14  
15  
16  
17  
18  
19  
20  
21  
22  
23

24  
25  
26 **Fig. 2.** The layout of the example network  
27

28  
29 [Near here]  
30  
31

#### 32 33 **4.1. Input and output variables** 34

35 The proposed FIS comprises two inputs, reliability and centrality (antecedents). The  
36 reliability values are shown in Fig. 2, ranging from 0.914 to 0.978. The  
37 corresponding reliability value of an edge refers to the probability that the edge  
38 remains functional at any given time (Gunawan *et al.*, 2017). We identify the values  
39 of centrality by obtaining the betweenness centrality of edges using *igraph*, an open  
40 source software package capable of calculating various structural properties of  
41 networks (Csardi and Nepusz, 2006). The values of edge betweenness centrality  
42 (number of shortest paths passing through each edge) for the example network are  
43 listed in Table 1.  
44  
45  
46  
47  
48  
49  
50  
51  
52  
53  
54  
55  
56  
57  
58  
59  
60

**Table 1.** Edge betweenness centrality of nodes in the case study

[Near here]

In the suggested model, each edge is associated with its reliability, as a measure of its likely behavior, along with its betweenness centrality, as a measure of its importance. The reliability of an edge is considered as a continuous variable in an interval of [0.90, 1.00] and the edge betweenness centrality is chosen in the interval [0,65]. The output of the FIS is a crisp value, termed vulnerability score, which is derived from fuzzification of both inputs (reliability and centrality) and output (vulnerability) by using the corresponding membership functions and fuzzy rules. In what follows, we discuss three consecutive steps, required for the development of our method, which are fuzzification, fuzzy inference engine, and defuzzification.

#### **4.2. Fuzzification and membership functions**

The first step to develop a fuzzy inference model is fuzzification. Reliability, centrality, and vulnerability are crisp variables. In order to apply fuzzy inference to process these crisp variables, we need to convert them to fuzzy variables. In doing so, we first define the linguistic variables for each fuzzy set and treat reliability, centrality, and vulnerability as these linguistic variables by providing a basis for approximate reasoning. The linguistic variables for reliability ( $R^L$ ), centrality ( $C^L$ ) and vulnerability ( $V^L$ ) are represented as follows:

$$R^L = \{Very\ high, High, Medium, Low\}$$

$$C^L = \{High, Medium, Low, Very\ low\}$$

$$V^L = \{Very\ high, High, Medium, Low, Very\ low\}$$

We then proceed with deriving the membership functions for these variables. There exist different types of membership functions in the literature, but triangles and trapezoids are most widely used owing to their ability to properly express expert knowledge and simplify the calculation process. In this article, the trapezoidal membership function is selected. Fig. 3 illustrates different types of trapezoidal membership functions utilized in this work.

**Fig. 3.** Different types of trapezoidal functions

[Near here]

The trapezoidal membership function is a function of vector  $x$  from the universe of discourse with four scalar constituents,  $a$ ,  $b$ ,  $c$ , and  $d$ , as given by the following mathematical expression.

$$\mu_A(x) = \begin{cases} 0, & (x < a) \text{ or } (x > d) \\ \frac{x - a}{b - a}, & a \leq x \leq b \\ 1, & b \leq x \leq c \\ \frac{d - x}{d - c}, & c \leq x \leq d \end{cases} \quad (5)$$

Two special cases of trapezoidal function, namely R-Function and L-Function are defined for the lower and the upper extreme cases.

R-Function with parameters  $a = b = -\infty$ , Fig. 3(b), where the value of the respective membership function of  $a$  and  $b$  is equal to the value of the first element in the universe of discourse, can be expressed as given below:

$$\mu_A(x) = \begin{cases} 0, & x > d \\ \frac{d-x}{d-c}, & c \leq x \leq d \\ 1, & x < c \end{cases} \quad (6)$$

L-Function with parameters  $c = d = +\infty$ , Fig. 3(c), where the value of the respective membership function of  $c$  and  $d$  is equal to the value of the last element in the universe of discourse, is given by the following mathematical expression:

$$\mu_A(x) = \begin{cases} 0, & x < a \\ \frac{x-a}{b-a}, & a \leq x \leq b \\ 1, & x > b \end{cases} \quad (7)$$

Various techniques of assigning membership functions to fuzzy variables are available such as intuition, inference, rank ordering, angular fuzzy sets, neural networks, genetic algorithms and inductive reasoning (Ross, 2017). Of these, we use the intuitive approach because it is derived from the capacity of humans to develop membership functions through their own innate intelligence and understanding (Zadeh and Kacprzyk, 1992). Table 2 reports the linguistic interpretations of reliability, centrality, and vulnerability. Type of membership functions and their scalar constituents (based on the intuitive approach) are also shown in this table.

**Table 2.** Linguistic variables and constituents of membership functions

[Near here]

It should be noted that the scalar constituents of the membership functions ( $a$ ,  $b$ ,  $c$  and  $d$ ) are assumed based on subjective perception of each linguistic variable in  $R^L$ ,  $C^L$  and  $V^L$  sets, using the reverse rating procedure (Norwich and Turksen, 1984). That is, the subject is presented with an ordered series of, for example, the reliability

1  
2  
3 values, then the reliability value best seeming to correspond to a given interval of  
4 membership values in each category of linguistic variables (e.g., very high, high,  
5 medium, low) is selected .  
6  
7  
8

9  
10 In order to provide a better visualization of the parameters, Fig. 4 illustrates the  
11 parameters of Table 2.  
12  
13

14  
15 **Fig. 4.** Fuzzy membership functions for

16 (a) Reliability, (b) Centrality and (c) Vulnerability  
17  
18

19  
20 [Near here]  
21  
22

23  
24 As can be observed from Fig. 4, each curve is a membership function corresponding  
25 to fuzzy variables, such as very high, high, medium, low, and very low. There are  
26 four membership functions for reliability, Fig. 4(a), four membership functions for  
27 centrality, Fig. 4(b) and five membership functions for vulnerability, Fig. 4(c). After  
28 the membership functions are constructed for the dual-inputs and the single-output of  
29 the model, the next step is to define the fuzzy control rules as per the following  
30 subsection.  
31  
32  
33  
34  
35  
36  
37  
38  
39

#### 40 ***4.3. Fuzzy inference engine and control rules***

41  
42 In the sequel, the linguistic quantifications of reliability, centrality, and vulnerability,  
43 described in the previous step, are used to specify a set of rules that capture  
44 knowledge about how the interplay between reliability and centrality controls the  
45 vulnerability of the network.  
46  
47  
48  
49  
50  
51  
52  
53  
54  
55  
56  
57  
58  
59  
60

Sixteen IF-THEN rules have been identified for integration of reliability and centrality so as to obtain the vulnerability score of edges in the case study. Table 3 presents these rules applied. The number in parentheses indicates the rule number.

**Table 3.** The relationship of linguistic variables for each fuzzy rule

[Near here]

After defining the fuzzy control rules, it is now time to process these rules. To this end, Mamdani fuzzy inference method is adopted. For the proposed FIS, the logic connective “AND”, Eq. (2), is utilized that is equivalent to select the minimum membership values for the reliability and centrality sets. The final step in the inference process is an aggregation of all outputs. In the aggregation step, the output of each rule whose antecedent has a non-zero matching degree is considered. The Max operator is employed herein to combine the outputs of fuzzy rules.

#### 4.4. Defuzzification

The use of 16 fuzzy control rules, discussed in the previous subsection, yields fuzzy quantities. In fact, we need a single crisp value representing the vulnerability score of each edge in the example network. To achieve this, defuzzification is applied to convert each subset of the fuzzy value of vulnerability to a crisp value.

For clarity, let us illustrate the aggregation along with the defuzzification process for obtaining the vulnerability score of edge 1. Based on the established membership function and fuzzy rules, the vulnerability score of edge 1 is associated with the reliability value of 0.966, belonging to *Medium* and *High* in the reliability membership function, and the centrality value of 24.25, belonging to *Low* in the centrality membership function. Rules 7 and 11 have antecedents with a non-zero

1  
2  
3 matching degree, therefore the vulnerability score is contributed by these rules. In  
4  
5 Fig. 5, these two rules governing the vulnerability of edge 1 is illustrated graphically.  
6  
7

8 **Fig. 5.** Fuzzy inference viewer of the proposed FIS- Edge 1  
9

10  
11 [Near here]  
12  
13

14 Since the 'AND' operation is used here, the fuzzy output for the rule 11 is the  
15 intersection of the paired values obtained from the reliability and centrality inputs, as  
16 shown in Fig. 5(d) and 5(e). The same procedure can be applied to the rule 7.  
17  
18

19 For a pair of reliability and centrality, two sets of fuzzy outputs exist, shown in Fig.  
20 5(c) and 5(f). It is now possible to aggregate these shapes using the 'Max' operator.  
21 The resulting shape is plotted in Fig. 5(g). As noted earlier, the output of the FIS  
22 should be a single scalar quantity, termed vulnerability score. As the last step, to  
23 determine the crisp value of vulnerability, the COG method is adopted to defuzzify  
24 the output function, as shown in Fig. 5(g). Thus, for a reliability value of 0.966 and a  
25 centrality value of 24.25, we obtain the vulnerability score of 0.346.  
26  
27  
28  
29  
30  
31  
32  
33  
34  
35  
36

## 37 **5. Results and discussion**

38 The crisp values of vulnerability score obtained from the suggested FIS method are  
39 reported in Table 4. Additionally, the vulnerability score is applied to rank the  
40 criticality of the edges in the case study. The grey column indicates the ranking of the  
41 example network's elements. The ranking is obtained from the vulnerability score,  
42 where the highest value holds the highest ranking implying the highest criticality.  
43  
44  
45  
46  
47  
48  
49  
50  
51

52 **Table 4.** Vulnerability scores obtained from the model  
53  
54  
55  
56  
57  
58  
59  
60

[Near here]

We now compare the ranking results obtained from the vulnerability score against the ranking results given by the reliability and the centrality of the edges. In the reliability-based ranking, the least value of the reliability denotes the highest criticality, while the ranking method based on the centrality values considers the highest criticality for the highest value of centrality. The ranking criticality of the edges is plotted in Fig. 6.

**Fig. 6.** Components criticality ranking based on the vulnerability score, reliability and centrality

[Near here]

Examination of Fig. 6 reveals a conspicuous difference between the resulting rankings. For instance, using the vulnerability score, edge 34 turns out to be the most critical element, whereas the centrality-based ranking method posits this element at the twenty-fifth position. This is because the ranking determination based on the centrality values does not allow for the interplay between the probability of a component being operable and the importance of the component within the network. In a similar vein, while the vulnerability score identifies edge 25 as the third most critical component, using the reliability value as the ranking measure, this edge is located at the eleventh position. Indeed, the reliability-based method ignores the fact that the consequences of the failure of this edge are sufficiently large due to its high value of centrality (61.38). As such, relying solely on the reliability or the centrality values for identifying the criticality of components can be deceiving. In contrast to the conventional vulnerability indices, the vulnerability score takes into account joint



1  
2  
3 considerations of the reliability and the centrality sets and thereby performing better  
4  
5 in a more accurate assessment of the vulnerability of components.  
6  
7

8 Moreover, the proposed FIS model has a high capacity for analyzing the results  
9  
10 through generating and plotting the output surface map for the system. Fig. 7  
11 illustrates 3D surface viewers generated by combining the reliability and the  
12 centrality sets by fuzzy rules. The surface viewer depicts the dependency of the  
13 vulnerability score as a function of reliability and centrality. The 3D plots also help  
14  
15 to examine the consistency of the rules framed in the FIS (Sharma *et al.*, 2005). For  
16  
17 example, a glance at Fig. 7 clearly shows that the vulnerability score decreases by  
18  
19 increasing reliability and decreasing centrality.  
20  
21  
22  
23  
24

25  
26 **Fig. 7.** Surface view of reliability, centrality, and vulnerability

27  
28  
29 [Near here]

30  
31  
32 Another advantage of the proposed FIS is simplicity in performing a sensitivity  
33 analysis by changing the input variables of the model. One can readily answer such  
34 questions as: “To what extent change in the reliability of an element affects the  
35 vulnerability of the network?” How different combinations of the reliability and the  
36 centrality values might affect the vulnerability score?”. As an example, by plotting  
37  
38 the fuzzy surface viewer for edge 25 (Fig. 8), assuming a constant centrality value of  
39  
40 61.38, it can be easily deduced that if the reliability of this element decreases from  
41  
42 0.949 to 0.920, the vulnerability score increases from 0.625 to 0.922.  
43  
44  
45  
46  
47  
48  
49

50 **Fig. 8.** The fuzzy surface viewer of the proposed FIS for edge 1

51  
52  
53 [Near here]

Up to this point, the vulnerability of the network has been assessed in a local sense. It is now possible to extend the vulnerability analysis further to the global level by distributing the vulnerability score values among different vulnerability states. As suggested by Rashedi and Hegazy (2016), we define five discrete vulnerability states and assign a linguistic variable to each state as follows: State 1=excellent, State 2=good, State 3=fair, State 4=poor, and State 5=critical. We now associate with each state an interval according to the FIS outputs as: State 1 $\in$  [0,0.20], State 2 $\in$  (0.20,0.40], State 3 $\in$  (0.40,0.60], State 4 $\in$  (0.60,0.80], and State 5 $\in$  (0.80,1.00]. We then accommodate each component into one of the aforementioned states based on the component vulnerability score value. Fig. 9 depicts the number of components in each state.

**Fig. 9.** Number of components in each vulnerability states

[Near here]

We finally define the global vulnerability status index,  $VI_g$ , as given below (Rashedi and Hegazy, 2016):

$$VI_g = \frac{\sum_{i=1}^5 (n_i \cdot i)}{\sum_{i=1}^5 n_i} \quad (8)$$

where  $i$  denotes the vulnerability state number, and  $n_i$  is the number of components in State  $i$ .

By substituting the number of components in each state into Eq. (8) we obtain  $VI_g = 2.71$ , indicating that the overall vulnerability state of the network falls between State 2 (good condition) and State 3 (fair condition). It is pertinent to

1  
2  
3 mention that  $VI_g$  is an approximate indicator of the global vulnerability status of the  
4  
5 networks and gives readers a rough idea of the overall vulnerability condition of the  
6  
7 network. A more precise evaluation of the global vulnerability requires using  
8  
9 analytical or simulation methods.  
10

## 11 12 13 **6. Conclusions** 14

15  
16 The methods presently used for vulnerability analysis of INs have typically followed  
17  
18 two distinct approaches: probabilistic-based methods and network theory-based  
19  
20 methods. While the probabilistic-based analysis addresses the vulnerability problem  
21  
22 by measuring the probability of maintaining the performance of an IN components,  
23  
24 the likelihood that these components become inoperable is missing in this approach.  
25  
26 Conversely, the network theory-based methods have seldom progressed beyond  
27  
28 evaluating the consequences of components failure, irrespective of the probability of  
29  
30 failure. From a vulnerability standpoint, neither sole utilization of the probabilistic  
31  
32 methods nor the stand-alone use of the network theory-based techniques is adequate  
33  
34 for a realistic vulnerability assessment of INs. Instead, it must be looked at as a  
35  
36 combination of these methods.  
37  
38

39  
40 The necessity to combine the probabilistic and the network-theory based approaches  
41  
42 motivated us to propose a FIS model due to its capability to represent the real-world  
43  
44 networks in a way that is very reminiscent of the way that humans perceive. The  
45  
46 presented FIS model deals with the problem of vulnerability analysis by joint  
47  
48 considerations of the parameters under scrutiny (i.e., reliability and centrality),  
49  
50 thereby providing a more realistic assessment of vulnerability.  
51  
52  
53  
54  
55  
56  
57  
58  
59  
60

1  
2  
3 Using an illustrative example from the literature, the article has described the way in  
4 which the reliability and centrality values, as the model inputs, interact with each  
5 other to generate the vulnerability score, as the model output. In addition, the paper  
6 has compared the effectiveness of the vulnerability score in criticality ranking of the  
7 components against the conventional vulnerability analysis methods, concluding that  
8 the vulnerability score performs better in identifying the criticality of components.  
9 The model result conforms to expectation. That is, the vulnerability score decreases  
10 by increasing reliability and decreasing centrality. Additionally, an attempt has been  
11 made to generate a global vulnerability index as an approximate indicator of the  
12 overall vulnerability status of the network.  
13  
14  
15  
16  
17  
18  
19  
20  
21  
22  
23

24  
25 Two key practical implications for vulnerability analysis of INs can be drawn from  
26 the suggested FIS model in this research. First, the maintenance strategy based on the  
27 vulnerability analysis proposed herein will provide an expert facilitator that helps  
28 infrastructure utilities to identify and prioritize the vulnerabilities. The second  
29 practical implication is especially valuable for designing an effective risk  
30 management framework, which allows for least cost decisions to be made for the  
31 protection of INs.  
32  
33  
34  
35  
36  
37  
38  
39  
40

41 This work contributes to vulnerability analysis of INs by mapping reliability and  
42 centrality to the vulnerability concept using fuzzy logic. However, a large number of  
43 probabilistic and network theory attributes are associated with the vulnerability of  
44 INs. Future work might seek to incorporate these factors into the proposed FIS  
45 model. We hope that our research encourages future research that offers a deeper  
46 insight into the vulnerability analysis of INs. For instance, further extended studies  
47 may adopt a complementary approach (e.g., system dynamics) for designing a  
48  
49  
50  
51  
52  
53  
54  
55  
56  
57  
58  
59  
60

dynamic model for vulnerability analysis that can be updated as the model parameters (e.g., reliability) change over time.

## References

1. Alipour, Z., Saniee Monfared, M.A., and Zio, E. 2014. Comparing topological and reliability-based vulnerability analysis of Iran power transmission network. *Proceedings of the Institution of Mechanical Engineers, Part O: Journal of Risk and Reliability*. **228**(2): 139-151.
2. Bai, Y., and Wang, D. 2006. Fundamental of fuzzy logic control- Fuzzy sets, fuzzy rules and defuzzifications. In Bai, Wang, and Zhuang (ed.) *Advanced Fuzzy Logic Technologies in Industrial Applications*. Springer- Verlag, London, UK, 17-36.
3. Bell, J.R. 2014. Subgroup centrality measures. *Network Science*. **2**(2): 277-297.
4. Bloomfield, R.E., Popov, P., Salako, k., Stankovic, V., and Wright, D. 2017. Preliminary interdependency analysis: An approach to support critical-infrastructure risk-assessment. *Reliability Engineering and System Safety*. **167**(2017): 198-217.
5. Boesch, F.T., Satyanarayana, A., and Suffel, C.L. 2009. A survey of some network reliability analysis and synthesis results. *Networks*. **54**(2): 99-107.
6. Boldi, P., and Vigna, S. 2014. Axioms for Centrality. *Internet Mathematics*. **10**(2014): 222-262.
7. Cadini, F., Zio, E., and Petrescu, A. 2009. Using centrality measures to rank the importance of the components of a complex network infrastructure. *Lecture Notes in Computer Science*. **5508**(2009): 155-167.
8. Casillas, J., Cordon, O., Herrera, F., and Magdalena, L. 2003. Interpretability improvements to find the balance interpretability-accuracy in fuzzy modeling: An overview. In Casillas, J., Cordon, O., Herrera, F., and Magdalena, L (Eds). *Interpretability Issues in Fuzzy Modeling*. Springer-Verlag, Heidelberg, Berlin, Germany:3-22.
9. Cavallaro, F. 2015. A Takagi-Sugeno fuzzy inference system for developing a sustainability index of Biomass. *Sustainability*. **7**(9): 12359-12371.
10. Csardi, G., and Nepusz, T. 2006. The igraph software package for complex network research. *International Journal of Complex Systems*. **1695**(5): 1-9.
11. Ezghari, S., Zahi, A., and Zenkouar, K. 2017. A new nearest neighbor classification method based on fuzzy set theory and aggregation operators. *Expert Systems with Applications*. **80**(2017): 58-74.
12. Fragiadakis, M., and Christodoulou, S.E. 2014. Seismic reliability of urban water networks. *Earthquake Engineering and Structural Dynamics*. **43**(3): 357-374.
13. Freeman, L.N. 1978. Centrality in social networks: Conceptual clarification. *Social Networks*. **1**(3): 215-239.
14. Gunawan, I., Schultmann, F., and Zarghami, S.A. 2017. The four Rs performance indicators of water distribution networks: A review of research literature. *International Journal of Quality & Reliability Management*. **34**(5): 720-732.
15. Gupta, M.M. 2011. Forty-five years of fuzzy sets and fuzzy logic- A tribute to Professor Lotfi A. Zadeh (the father of fuzzy logic). *Scientia Iranica: Transaction D, Computer Science & Engineering and Electrical Engineering*: **18**(3): 685-690.

16. Hernandez-Fajardo, I., and Dueñas-Osorio, L. 2013. Probabilistic study of cascading failures in complex interdependent lifeline systems. *Reliability Engineering and System Safety*. **111**(2013): 260-272.
17. Holmgren, A.J. 2006. Using graph models to analyze the vulnerability of electric power networks. *Risk Analysis*. **26**(4): 955-969.
18. Islam, M.S., Sadiq, R., Rodriguez, M.J., Najjaran, H., and Hoorfar, M. 2014. Reliability assessment for water supply systems under uncertainties. *Journal of Water Resources Planning and Management*. **140**(4): 468-476.
19. Johansson, J., Hassel, H., and Zio, E. 2013. Reliability and vulnerability analysis of critical infrastructures: Comparing two approaches in the context of power systems. *Reliability Engineering and System Safety*. **120**(2013): 27-38.
20. Jönsson, H., Johansson, J., and Johansson, H. 2008. Identifying critical components in technical infrastructure networks. *Proceedings of the Institution of Mechanical Engineers, Part O: Journal of Risk and Reliability*. **222**(2): 235-243.
21. Joyce K, Laurienti PJ, Burdette JH, Hayasaka S. 2010. A new measure of centrality for brain networks. *PLoS One*. **5**(8): e12200.
22. Kluska, J. 2009. *Studies in Fuzziness and Soft Computing: Analytical Methods in Fuzzy Modeling and Control*. Springer-Verlag, Heidelberg, Berlin, Germany.
23. Lawyer, G. 2015. Understanding the influence of all nodes in a network: a continuous time-perspective, *Scientific Reports*. **5**(2015): 8665, 1-9.
24. Lozares, C., Lopez-Roldan, P., Bolibar, M., and Montanyola, D. 2015. The structure of global centrality measures, *International Journal of Social Research Methodology*. **18**(2): 209-226.
25. Monge, P.R., and Contractor, N.S. 2003. *Theories of Communication Networks*, Oxford University Press, New York, USA.
26. Murray, A.T., and Grubestic, T.H. 2007. Critical Infrastructure Reliability and Vulnerability. In Murray, A.T., and Grubestic, T.H (Eds). *Overview of Reliability and Vulnerability Critical Infrastructure*. Springer-Verlag, Heidelberg, Berlin, Germany:1-8.
27. Nicholson, C.D., Barker, K., and Ramirez-Marquez, J.E. 2016. Flow-based vulnerability measures for network component importance: Experimentation with preparedness planning. *Reliability Engineering and System Safety*. **145**(2016): 62-73.
28. Norwich, A.M., and Turksen, I.B. 1984. A model for the measurement of membership and the consequences of its empirical implementation. *Fuzzy Sets and Systems*. **12**(1): 1-25.
29. Ouyang, M. 2016. Critical location identification and vulnerability analysis of interdependent infrastructure systems under spatially localized attacks. *Reliability Engineering and System Safety*. **154**(2016): 106-116.
30. Pham, D.T., and Castellani, M. 2002. Action aggregation and defuzzification in Mamdani-type fuzzy systems. In *Proceedings of the Institution of Mechanical Engineering, Part C: Journal of Mechanical Engineering Science*. **216**(7): 747-759.
31. Praks, P., Kopustinskas, V., Masera, M. 2015. Probabilistic modelling of security of supply in gas networks and evaluation of new infrastructure. *Reliability Engineering and System Safety*. **144**(2015): 254-264.
32. Pourjavad, E., and Shahin, A. 2018. The application of Mamdani fuzzy inference system in evaluating green supply chain management performance. *International Journal of Fuzzy Systems*. **20**(3): 901-912.

- 1  
2  
3  
4  
5  
6  
7  
8  
9  
10  
11  
12  
13  
14  
15  
16  
17  
18  
19  
20  
21  
22  
23  
24  
25  
26  
27  
28  
29  
30  
31  
32  
33  
34  
35  
36  
37  
38  
39  
40  
41  
42  
43  
44  
45  
46  
47  
48  
49  
50  
51  
52  
53  
54  
55  
56  
57  
58  
59  
60
33. Rashedi, R., and Hegazy, T. 2016. Holistic Analysis of Infrastructure Deterioration and Rehabilitation Using System Dynamics. *Journal of Infrastructure Systems*. **22**(1):04015016(10).
  34. Ross, T.J. 2017. *Fuzzy Logic with Engineering Application (Fourth Edition)*, John Wiley & Sons.
  35. Sharma, R.K., Kumar, D., and Kumar, P. 2005. Systematic failure mode effect analysis (FMEA) using fuzzy linguistic model. *International Journal of Quality & Reliability Management*. **22**(9), 986-1004.
  36. Shuang, Q., Liy, Y., Tang, Y., Liu, J., and Shuang, K. 2017. System reliability evaluation in water distribution networks with the impact of valves experiencing cascading failures. *Water*. **9**(6), 413:1-17.
  37. Shuang, Q., Zhang, M., and Yuan, Y. 2014. Performance and reliability analysis of water distribution systems under cascading failures and the identification of crucial pipes. *PLoS ONE*. **9**(2): e88445.
  38. Taylor, M.A.P., Sekhar, S.V.C, and D'Este, G. 2006. Application of accessibility based methods for vulnerability analysis of strategic road networks. *Networks and Spatial Economics*. **6**(3-4):267-291.
  39. Thacker, S., Pant, R., and Hall, J.W. 2017. System-of-systems formulation and disruption analysis for multi-scale critical national infrastructures. *Reliability Engineering and System Safety*. **167**(2017): 30-41.
  40. Wang, X., Jiang, X., and Pattavina, A. 2011. Assessing network vulnerability under probabilistic failure network model. In *Proceedings of 12<sup>th</sup> IEEE International Conference High Performance Switching and Routing (HPSR)*:164-170.
  41. Yazdani, A., and Jeffrey, P. 2012. Water distribution system vulnerability analysis using weighted and directed network models. *Water Resources Research*. **48**(6): W06517:1-10.
  42. Zadeh, L.A. 1965. Fuzzy sets. *International Journal of Information and Control*. **8**(1965): 338-353.
  43. Zadeh, L.A., and Kacprzyk, J. 1992. *Fuzzy Logic for Management of Uncertainty*. John Wiley & Sons, New York, USA.
  44. Zarghami, S.A., Gunawan, I., and Schultmann, F. 2018a. Vulnerability analysis of water distribution networks using betweenness centrality and information entropy. In *Proceedings of the 2<sup>nd</sup> IEOM European Conference on Industrial Engineering and Operations Management*.
  45. Zarghami, S.A., Gunawan, I., and Schultmann, F. 2018b. Integrating entropy theory and cospanning tree technique for redundancy analysis of water distribution networks. *Reliability Engineering and System Safety*. **176**(2018): 102-112.
  46. Zhang, C., Ramirez-Marquez, J.E., and Sanseverino C.M.R. 2011. A holistic method for reliability performance assessment and critical components detection in complex networks. *IIE Transactions*. **43**(9): 661-675.

**Table 1.** Edge betweenness centrality of nodes in the case study

$i$	$C_B(i)$	$i$	$C_B(i)$	$i$	$C_B(i)$
1	24.25	14	17.54	27	28.84
2	23.42	15	27.50	28	17.12
3	37.70	16	45.49	29	32.88
4	32.46	17	43.69	30	36.69
5	39.84	18	27.32	31	47.31
6	23.45	19	19.25	32	26.00
7	38.88	20	40.02	33	11.04
8	37.89	21	47.16	34	24.78
9	23.35	22	49.07	35	21.17
10	15.65	23	24.50	36	30.77
11	42.74	24	30.01	37	19.24
12	46.69	25	61.38	38	9.33
13	47.38	26	50.22		



**Table 2.** Linguistic variables and constituents of membership functions

Variable	Linguistic variables	Trapezoid Type	<i>a</i>	<i>b</i>	<i>c</i>	<i>d</i>
Reliability	Very high	L-Function	0.97	0.99	$+\infty$	$+\infty$
Reliability	High	Regular	0.94	0.96	0.97	0.99
Reliability	Medium	Regular	0.92	0.94	0.95	0.97
Reliability	Low	R-Function	$-\infty$	$-\infty$	0.92	0.94
Centrality	High	L-Function	45	55	$+\infty$	$+\infty$
Centrality	Medium	Regular	25	35	45	55
Centrality	Low	Regular	10	20	30	40
Centrality	Very low	R-Function	$-\infty$	$-\infty$	10	20
Vulnerability	Very high	L-Function	0.80	0.90	$+\infty$	$+\infty$
Vulnerability	High	Regular	0.50	0.65	0.75	0.90
Vulnerability	Medium	Regular	0.30	0.45	0.55	0.70
Vulnerability	Low	Regular	0.10	0.25	0.35	0.50
Vulnerability	Very low	R-Function	$-\infty$	$-\infty$	0.10	0.20

**Table 3.** The relationship of linguistic variables for each fuzzy rule

		<i>Centrality</i>			
		<i>High</i>	<i>Medium</i>	<i>Low</i>	<i>Very low</i>
<i>Reliability</i>	<i>Very high</i>	<i>Low</i> (1)	<i>Low</i> (2)	<i>Very low</i> (3)	<i>Very low</i> (4)
	<i>High</i>	<i>Medium</i> (5)	<i>Medium</i> (6)	<i>Low</i> (7)	<i>Low</i> (8)
	<i>Medium</i>	<i>High</i> (9)	<i>Medium</i> (10)	<i>Medium</i> (11)	<i>Low</i> (12)
	<i>Low</i>	<i>Very high</i> (13)	<i>High</i> (14)	<i>High</i> (15)	<i>Medium</i> (16)

**Table 4.** The vulnerability scores obtained from the model

<i>Edge</i>	<i>Vulnerability Score</i>	<i>Rank</i>	<i>Edge</i>	<i>Vulnerability Score</i>	<i>Rank</i>
1	0.346	33	20	0.5	11
2	0.277	37	21	0.546	7
3	0.39	30	22	0.546	7
4	0.405	22	23	0.43	18
5	0.402	24	24	0.4	25
6	0.3	36	25	0.625	3
7	0.471	14	26	0.581	4
8	0.334	34	27	0.4	25
9	0.277	37	28	0.634	2
10	0.396	28	29	0.409	21
11	0.472	13	30	0.437	16
12	0.432	17	31	0.55	6
13	0.552	5	32	0.403	23
14	0.411	20	33	0.312	35
15	0.399	27	34	0.661	1
16	0.514	10	35	0.396	28
17	0.5	11	36	0.418	19
18	0.387	31	37	0.517	9
19	0.439	15	38	0.35	32

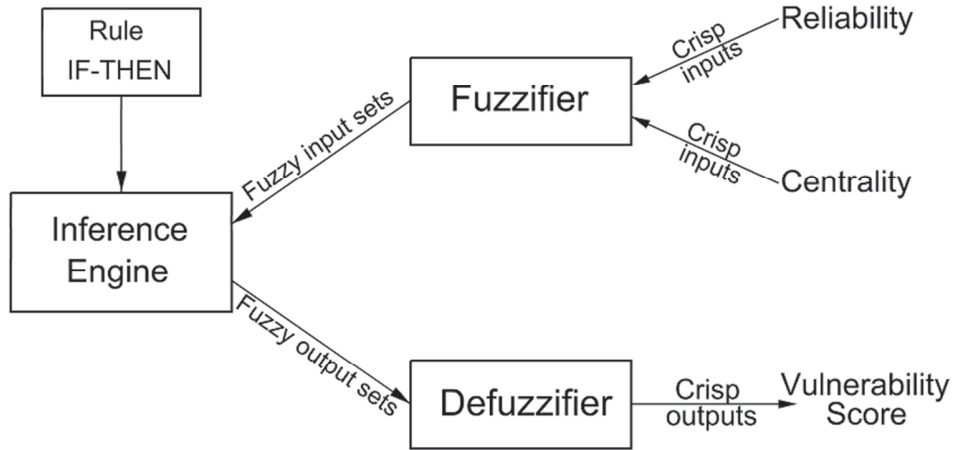


Fig.1- Schematic chart of the fuzzy logic process

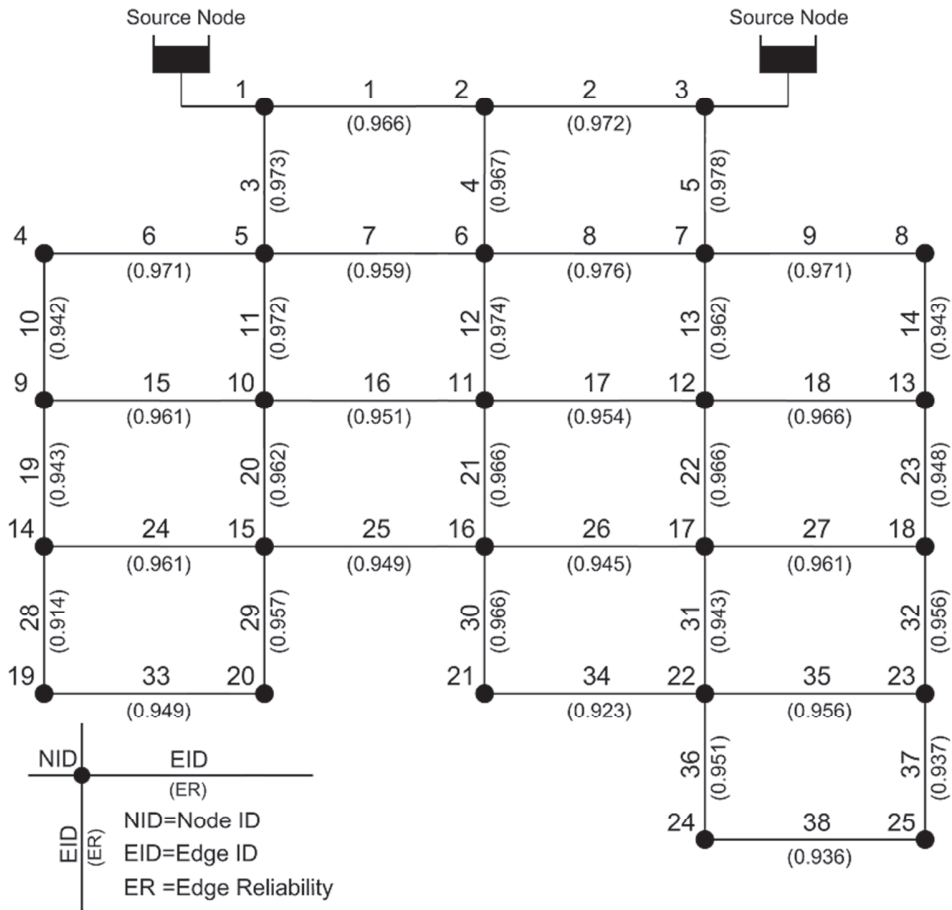


Fig.2- The layout of the example network

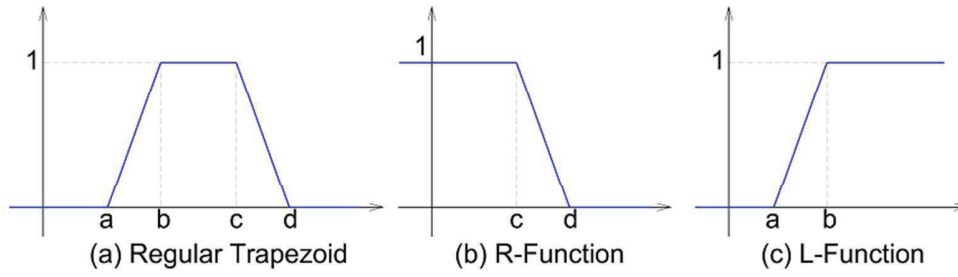


Fig.3- Different types of trapezoidal functions

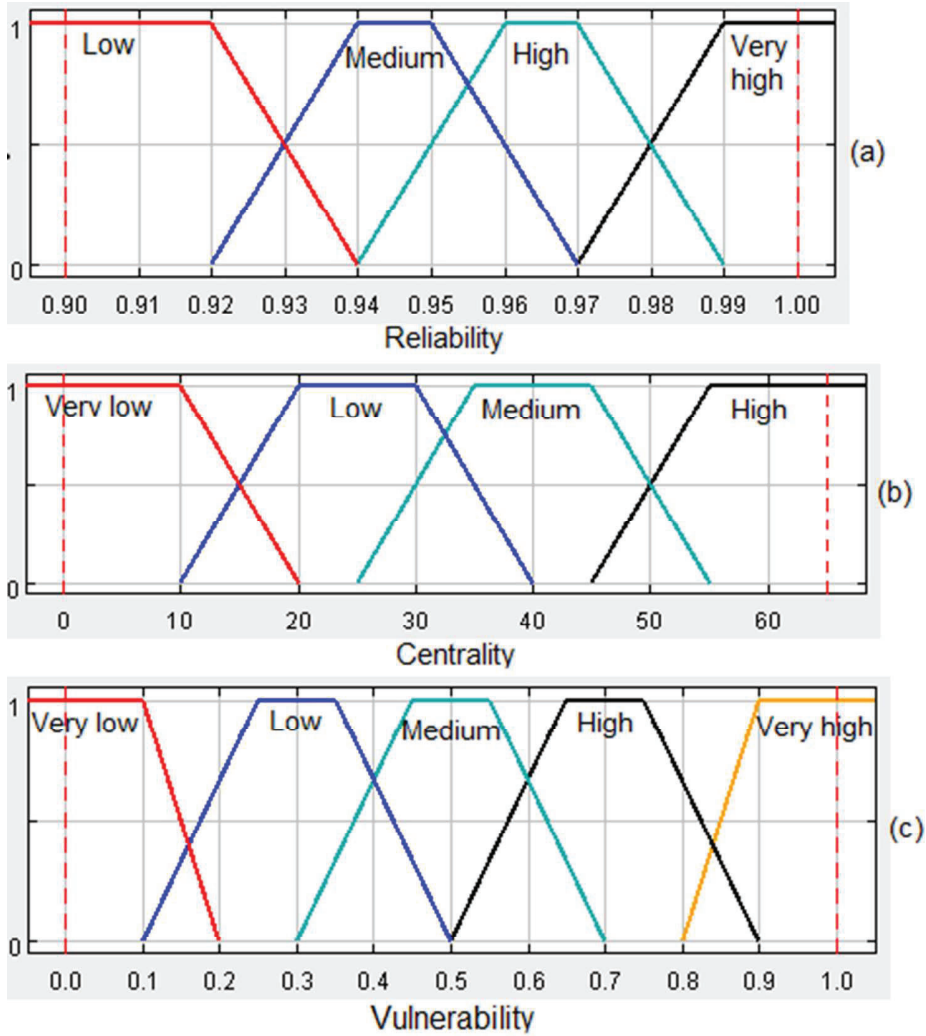


Fig.4- Fuzzy membership functions for!! + (a) Reliability, (b) Centrality and (c) Vulnerability!! +

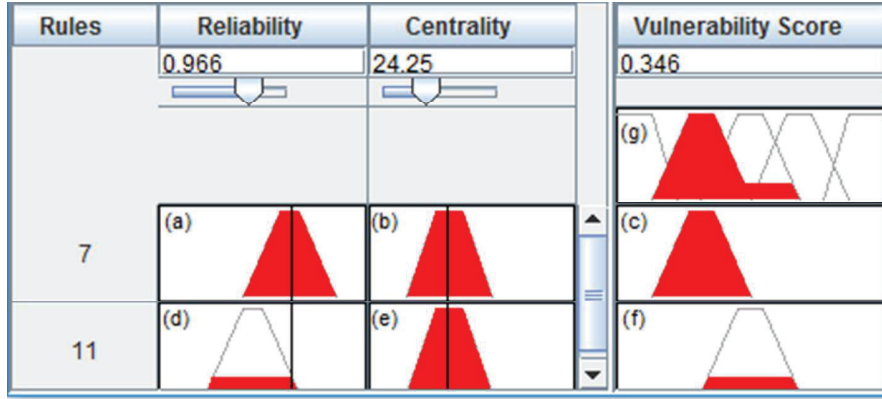


Fig.5- Fuzzy inference viewer of the proposed FIS- Edge 1





Fig.6- Components criticality ranking based on the vulnerability score, reliability and centrality

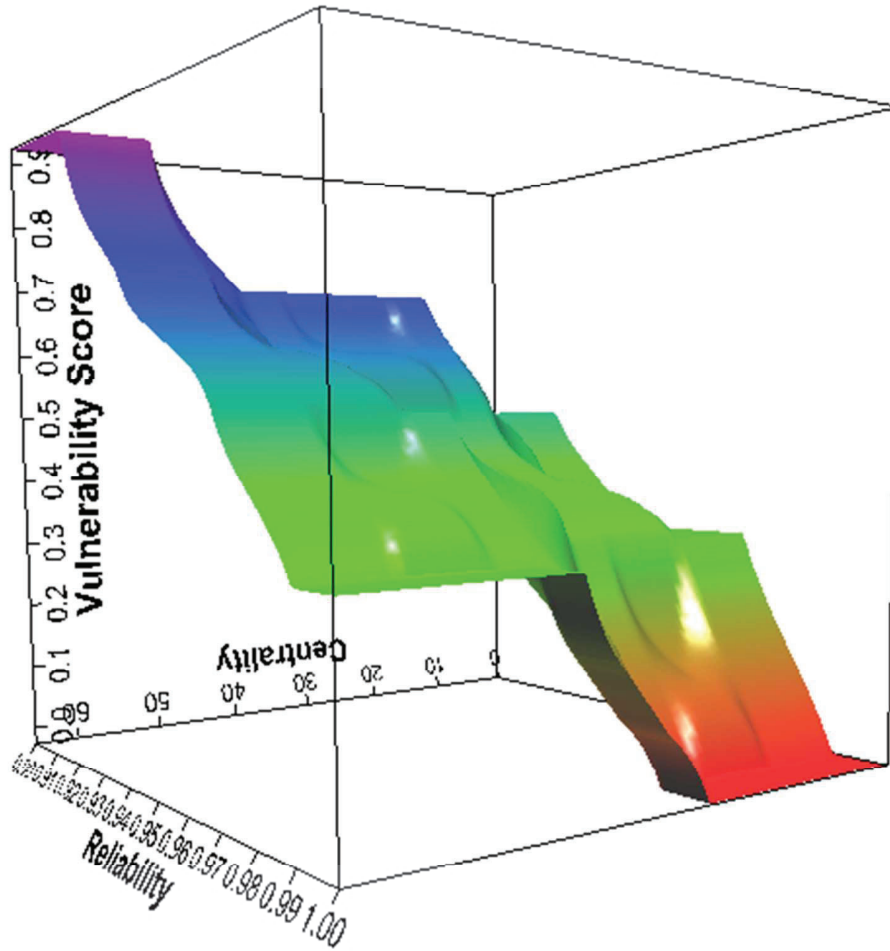


Fig.7- Surface view of reliability, centrality, and vulnerability

1  
2  
3  
4  
5  
6  
7  
8  
9  
10  
11  
12  
13  
14  
15  
16  
17  
18  
19  
20  
21  
22  
23  
24  
25  
26  
27  
28  
29  
30  
31  
32  
33  
34  
35  
36  
37  
38  
39  
40  
41  
42  
43  
44  
45  
46  
47  
48  
49  
50  
51  
52  
53  
54  
55  
56  
57  
58  
59  
60

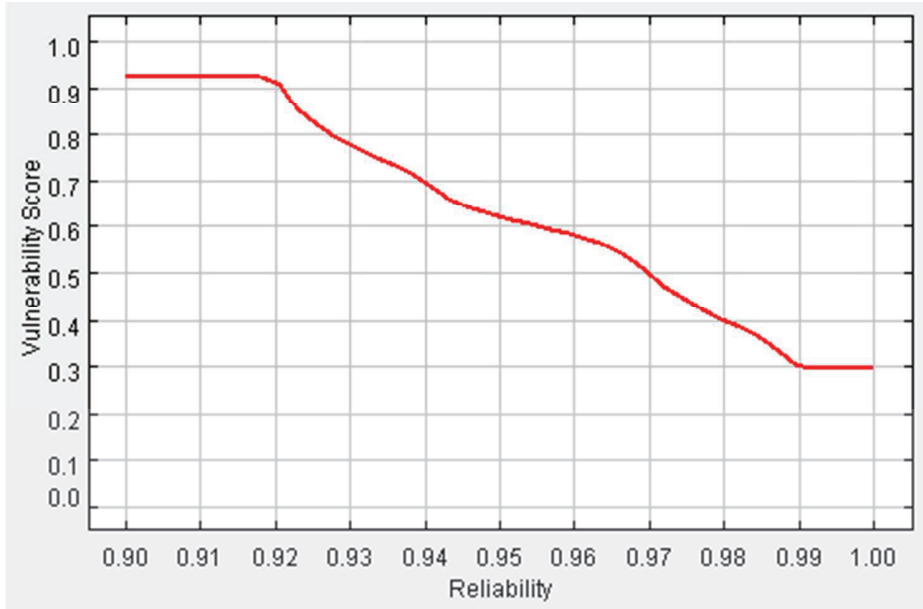


Fig.8- The fuzzy surface viewer of the proposed FIS for edge 1

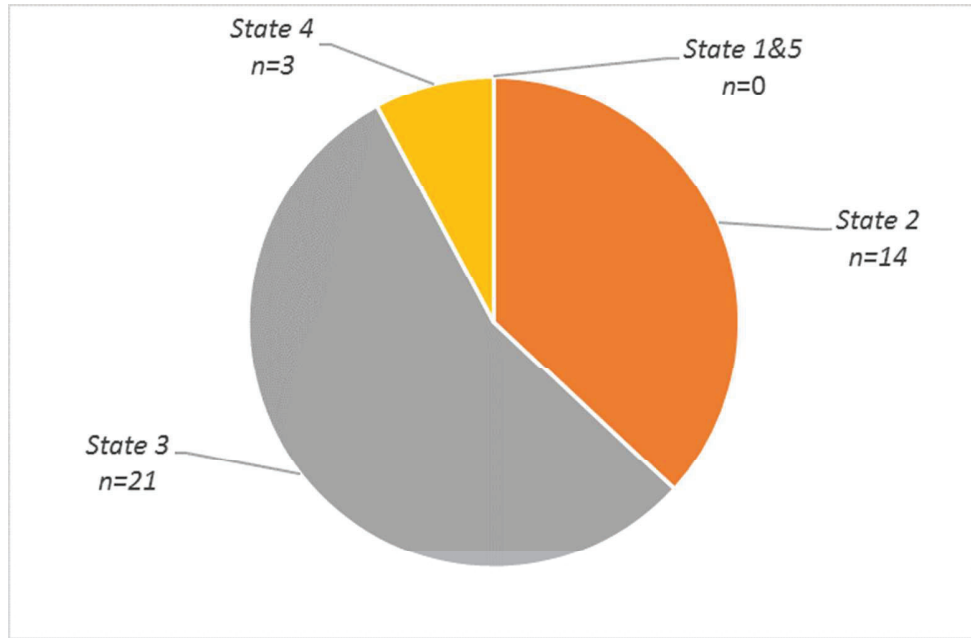


Fig.9- Number of components in each vulnerability states

# *Chapter 7*

## Integrating Topological and Hydraulic Attributes of WDNs

## 7. Integrating Topological and Hydraulic Attributes of WDNs

### 7.1. Paper 7: Integrating topological and hydraulic attributes for robustness analysis of water distribution networks

#### Statement of Authorship

Title of Paper	Integrating Topological and Hydraulic Attributes for Robustness Analysis of Water Distribution Networks
Publication Status	<input type="checkbox"/> Published <input checked="" type="checkbox"/> Accepted for Publication <input type="checkbox"/> Submitted for Publication <input type="checkbox"/> Unpublished and Unsubmitted work written in manuscript style
Publication Details	Zarghami S.A., Gunawan, I., & Schultmann, F. (2019). Integrating Topological and Hydraulic Attributes for Robustness Analysis of Water Distribution Networks. <i>International Journal of Industrial Engineering and Operations Management</i> . Accepted. In press

#### Principal Author

Name of Principal Author (Candidate)	Seyed Ashkan Zarghami				
Contribution to the Paper	Design the model and computational framework- Developing the theory- Proposing a new method- Performing the analytic calculations- Demonstrating the proposed method on case studies-Discussion of results- Identifying avenues for future work- Writing the manuscript				
Overall percentage (%)	85%				
Certification:	This paper reports on original research I conducted during the period of my Higher Degree by Research candidature and is not subject to any obligations or contractual agreements with a third party that would constrain its inclusion in this thesis. I am the primary author of this paper.				
Signature	<table border="1" style="width: 100%;"> <tr> <td style="width: 80%;"></td> <td style="width: 20%;">Date</td> </tr> <tr> <td></td> <td>22/06/2018</td> </tr> </table>		Date		22/06/2018
	Date				
	22/06/2018				

#### Co-Author Contributions

By signing the Statement of Authorship, each author certifies that:

- i. the candidate's stated contribution to the publication is accurate (as detailed above);
- ii. permission is granted for the candidate to include the publication in the thesis; and
- iii. the sum of all co-author contributions is equal to 100% less the candidate's stated contribution.

Name of Co-Author	Associate Professor Indra Gunawan				
Contribution to the Paper	Supervising development of the work- Verifying the numerical results- Evaluation of the manuscript- Helping to edit the manuscript-Final approval of the version to be published				
Signature	<table border="1" style="width: 100%;"> <tr> <td style="width: 80%;"></td> <td style="width: 20%;">Date</td> </tr> <tr> <td></td> <td>8/8/19</td> </tr> </table>		Date		8/8/19
	Date				
	8/8/19				

Name of Co-Author	Professor Frank Schultmann				
Contribution to the Paper	Supervising development of the work –Helping to edit the manuscript- Final approval of the version to be published				
Signature	<table border="1" style="width: 100%;"> <tr> <td style="width: 80%;"></td> <td style="width: 20%;">Date</td> </tr> <tr> <td></td> <td>01/08/2019</td> </tr> </table>		Date		01/08/2019
	Date				
	01/08/2019				

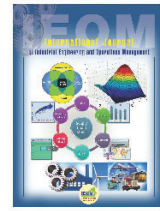
Please cut and paste additional co-author panels here as required.



IEOM Society  
International

International Journal of Industrial Engineering and  
Operations Management (IJIEOM)

Volume 1, No. 1, May 2019  
pp. xx - xx



## **Integrating Topological and Hydraulic Attributes for Robustness Analysis of Water Distribution Networks**

**Seyed Ashkan Zarghami, Indra Gunawan, Frank Schultmann**

Entrepreneurship, Commercialisation & Innovation Centre (ECIC), The University of Adelaide,  
Australia

ashkan.zarghami@adelaide.edu.au

### **ABSTRACT**

Researchers are recognizing that the robustness evaluation of Water Distribution Networks (WDNs) is of great importance for reducing the impact of disruptive events. Yet, very few methods to measure the robustness of WDNs have been developed. These methods mainly focus on either the topological features or the hydraulic attributes of WDNs and fail to provide a comprehensive picture of the robustness characteristics of WDNs. The work described herein proposes a new robustness index to measure the heterogeneity of WDNs drawing on informational entropy theory. The paper attempts to shift away from an exclusive topological viewpoint or a pure hydraulic approach, towards a combined topological and hydraulic analysis. The main emphasis is on the influence of an individual node on the overall network performance. The use of the proposed index is illustrated with a real-world WDN of an Australian town. The results highlight the significance of integrating the topological and hydraulic metrics for a reliable assessment of robustness in WDNs.

### **ARTICLE INFO**

Received  
May 1, 2018  
Received in revised  
form  
May 2018  
Accepted  
June 22, 2018

### **KEYWORDS**

Degree distribution;  
Demand fraction;  
Informational entropy;  
Robustness; Water  
distribution networks.

## 1. Introduction

Water Distribution Networks (WDNs) are among the most significant critical infrastructures with a high degree of complexity. Disruption and dysfunction of WDNs would have debilitating effects on different aspects of human life such as safety, economic, security, public health and social well-being (Gunawan et al., 2017). In this respect, it is imperative to have proper measures to evaluate the robustness of WDNs in order to reduce the impact of disruptive events.

There is no unique interpretation of the robustness of complex networks. Extant literature has presented multiple and rather contradicting definitions of robustness. Carlson and Doyle (2002) define the robustness as the ability of a system to fulfill its desired characteristics despite fluctuations in its components behavior. In the work of Li et al. (2008), robustness is seen as the ability of the system to avoid malfunction when a fraction of its components are failed. Cuadra et al. (2015) regard the robustness in complex networks as the opposite of vulnerability, which accounts for the reliability of the system. Ferrario et al. (2016) define the robustness as the capability of the network to provide the required level of supply of good when the system is exposed to partial failures. Robustness is also defined as the ability of a network to cope with faults during operations (Agathokleous et al., 2017). Although a broad definition of robustness exists, this work addresses the question of system robustness based on Iyer et al. (2013) by analyzing how the network structure and function change as a node is removed.

In recent years, a great deal of research has been conducted on evaluating the robustness of complex networks. Wang et al. (2014) quantified the influence of adding and removing links on the robustness of the complex infrastructural networks by using a graph-based metric. Schieber et al. (2015) proposed a metric for network robustness based on an information theory quantifier by measuring dissimilarities between topologies after each time step of the sequence. Lin et al. (2010) viewed the variability of the degree distribution of the nodes as a key determinant of the network structure. Many researchers have utilized the entropy of degree distribution in order to measure the heterogeneity and therefore robustness of complex networks (Jiang et al. 2014). The entropy of degree distribution as a measure of the network's heterogeneity was computed in the work of Sole and Valverde (2004). Wang et al. (2006) and Wu et al., (2007) investigated the relationship between the entropy of the degree distribution in scale-free networks and the robustness of these networks.

Although researchers have explored innovative methods to quantify the robustness of complex networks, a few methods to measure the robustness of WDNs has been developed hitherto. These methods can be broadly classified into two distinct categories: topological, and hydraulic. In the topological methods, the network robustness is assessed by using a graph invariant from graph theory. Yazdani and Jeffrey (2012a, 2012b) are among a few researchers that quantified the robustness of WDNs by using graph invariants such as meshedness coefficient, spectral gap, and algebraic connectivity metrics. Most existing literature has studied the robustness of WDNs along with the network reliability by taking a hydraulic viewpoint. For example, Greco et al. (2012) developed an entropy-based demand-driven approach for measuring the robustness of WDNs. Jung et al., (2014) proposed a robustness index by measuring the variation of the system hydraulic performances. Agudelo-Vera et al., (2014) examined the robustness of drinking WDNs based on two main hydraulic parameters: minimal pressure and water quality presented as water age.

The research just cited is embedded in embracing either the topological features or the functional attributes of WDNs and therefore have particular strengths and weaknesses. On the one hand, pure topological measurements of the robustness WDNs are useful to describe the network structure, but they fail to properly characterize the network properties (Yazdani and Jeffrey, 2011). On the other hand, relying solely on the hydraulic properties of WDNs hinders a modeler to evaluate the robustness inherent within the layout of the network.

The overarching aim of this research is to shift away from a pure topological perspective or an exclusive hydraulic viewpoint towards a combined topological and hydraulic analysis in order to present a more accurate measure of the WDNs robustness. We advocate the idea that an extensive evaluation of the network robustness depends not only on the topological measurements but also on the functional attributes of the network (Yazdani et al., 2011). It is in this spirit that this work proposes a combined topological and hydraulic metric for measuring the robustness of WDNs based on the principle that a network with uniformly distributed values of the required demand along with an equiprobable distribution of the nodal degree sequence, exhibits a lower drop in performance in the case of partial failure of nodes. To this end, the paper develops a methodology, using informational entropy theory, for evaluating the robustness of WDNs. The research focuses on a joint entropy model by coupling two entropy metrics: degree distribution entropy-based metric denoting the topological attributes of the nodes and demand fraction entropy-based metric representing the hydraulic attributes of the nodes in the network.



The proposed robustness analysis method differs from the conventional methods along three key dimensions. First, in contrast to the conventional methods in which the robustness of a WDN is mainly assessed based on the network reliability, this research addresses the robustness of a network by removing a node and subsequently measuring its influence on the overall performance of the network. This is precisely consistent with the preceding definition of the robustness. Second, by situating our research in the informational entropy context, we demonstrate how evaluating the statistical diversity of the hydraulic and topological attributes of WDNs can be interpreted as a measure of the network robustness. Third, this research gives a vivid account of the network robustness by taking into account the joint consideration of the nodal demands, as a hydraulic attribute, along with the nodal degree distribution, as a structural property.

In what follows, Section 2 reviews the degree distribution and demand fraction entropy-based metrics, followed by developing a joint entropy-based index to measure the robustness of WDNs. In Section 3, the proposed robustness index is applied to a real-world case study. Section 4 is devoted to a discussion of the results obtained from the proposed method. The paper is concluded in Section 5 and areas for further research are discussed in the end.

## 2. Provenance of Entropy-Based Robustness Index

To begin to assess the robustness of WDNs, first, the notion of informational entropy is briefly described, which can be leveraged to evaluate the robustness of the network.

The classic definition of informational entropy attributed to Shannon (1948) measures choice and uncertainty. Shannon entropy of a set of probabilities  $P = \{p_i: i = 1, 2, \dots, n\}$ , can be formulated as follow:

$$H = - \sum_{i=1}^n p_i \log_b p_i \quad (1)$$

where  $H$  is entropy of distribution,  $n$  is the number of possible outcomes and  $b$  is an arbitrary logarithm base by which the unit of entropy is defined. For  $b=2$ ,  $b=e$ , and  $b=10$ , the units are defined as bits, Napier, and decibels, respectively.

The informational entropy has been found to have useful applications in a wide range of areas, including evaluating the reliability and redundancy of WDNs (e.g. Awumah *et al.*; 1991; Tanyimboh, 2017; Zarghami *et al.*, 2018a), hydrology (e.g. Li *et al.*, 2012), transportation networks (e.g. Wu *et al.*, 2013), and medical science (e.g. Sato *et al.*, 2013). In this section, the principle of informational entropy is adopted as the measure of statistical diversity of degree and demand distribution in WDNs. The remainder of this section demonstrates how the diversity of variables, obtained as results of informational entropy, can be interpreted in terms of the network robustness.

### 2.1. Entropy of degree distribution

We now adopt a graph theory quantity known as the degree of a node. The degree of a node is the number of links that connect the node to other nodes. The degree distribution,  $g_k$ , is the probability that a randomly chosen node has  $k$  links. Valuable information on intrinsic network structure can be inferred from the node degree distribution (Pozrikidis, 2016). As discussed earlier, the entropy of degree distribution has been widely used as a measurement of robustness for complex systems. Here this notion is recalled so as to provide helpful clarification.

Let  $k_i$  be the degree value of node  $i$  and let  $\{g_1, g_2, \dots, g_\Delta\}$  define the degree sequence distribution of the network, where  $g_k$  is the fraction of nodes with degree  $k$ . The entropy of degree distribution of a network, that is,  $H_d$ , is a measure of heterogeneity in the network, which can be formulated as:

$$H_d = - \sum_{k=1}^{\Delta} g_k \log_2(g_k) \quad (2)$$

where  $\Delta$  represents the maximum degree of nodes in the network. The higher value of  $H_d$  denotes more diversity in link distribution. Intuitively, diversity in degree distribution increases the robustness of the network, thus the higher the entropy of the degree distribution, the more robust of the network is.  $H_d$  attains its maximum value ( $\log_2 \Delta$ ) when  $g_k = \frac{1}{\Delta}$  for any node degree  $k$ , and its minimum value 0 when the node degrees are either 0 or 1.

Despite a broad use of the degree distribution entropy-based metric in assessing the robustness of networks,  $H_d$  only captures very generic topological information of the complex networks and therefore is poorly informative. A reliable robustness assessment of WDNs requires further specification of topological and hydraulic features of the network. Moreover, in WDNs the maximum nodal degree is generally very low because such networks are located on a two-dimensional space, which are constrained, by a number of impediments, therefore the results obtained from the stand-alone use of the entropy-based degree distribution metrics might be unreliable (Giustolisi *et al.*, 2016).

## 2.2. Entropy of demand fraction

With the aim of addressing the aforementioned shortcoming of the degree distribution entropy-based metric, the robustness evaluation of WDNs is now extended by proposing a new hydraulic measurement, called *demand fraction entropy-based robustness metric*, ( $H_q$ ).

Let a network consists of  $N$  nodes and let the required flow (demand) at node  $i$  be denoted by  $q_i$ . For node  $i$ , the parameter  $p_i$  in Eq. (1) is defined as:

$$p_i = \frac{q_i}{Q_t} \quad (3)$$

where  $p_i$  is demand fraction at node  $i$ , and  $Q_t$  is the total required flow of the network and given by:

$$Q_t = \sum_{i=1}^N q_i \quad (4)$$

The parameter  $p_i$  can be interpreted as a probability value for  $q_i$ . It represents the contribution of node  $i$  to the total flow of the network. To develop the demand fraction entropy-based robustness metric, Eq. (1) can be restated as follows:

$$H_q = - \sum_{i=1}^N \left( \frac{q_i}{Q_t} \right) \log_2 \left( \frac{q_i}{Q_t} \right) \quad (5)$$

Since  $\sum_{i=1}^N p_i = 1$ , the variables of the set  $P = \{p_i: i = 1, 2, \dots, n\}$  are conditionally reliant on each other. That is, if the demand fraction at a particular node increases, the summation of all other variables tends to decrease and vice versa. From the informational entropy perspective, thus,  $H_q$  can be constructed as a measure of the network robustness that indicates the degree of severity of the single failure of nodes. The intuitive interpretation of  $H_q$  is that a critical node with the highest value of demand fractions contributes more to the drop in overall network performance in response to random failures. In fact, removal of a node with a high demand fraction leaves a larger number of households without water supply in comparison to the failure of nodes with lower demand fractions. Thus, it is more advantageous from the robustness point of view, if all nodes are of equal value of demand fraction.

## 2.3. Joint entropy of degree distribution and demand fraction

To achieve a reliable assessment of the robustness, the authors argue that the focus should shift away from an exclusive topological viewpoint or a pure hydraulic approach, towards a combined topological and hydraulic analysis. To this end, the paper proposes a new index drawing on the joint entropy of degree distribution and demand fraction in order to measure the robustness of WDNs.

The joint entropy,  $H(X_1, X_2)$ , of a pair of random variables with a set of joint probability of  $\{p_{ij}: i = 1, 2, \dots, N; j = 1, 2, \dots, M\}$ , is defined as:

$$H(X_1, X_2) = - \sum_{i=1}^N \sum_{j=1}^M p_{ij} \log_2(p_{ij}) \leq H(X_1) + H(X_2) \quad (6)$$

Demand fraction and degree distribution are stochastically independent variables, hence their joint entropy can be obtained from the following equation (Singh, 2013):

$$H(d, q) = H_d + H_q \quad (7)$$

For a network with  $N$  nodes and the maximum degree of  $\Delta$ ,  $H(d, q)$  is maximum when  $g_i = \frac{1}{\Delta}$  and  $q_i = \frac{Q_i}{N}$ , hence:

$$H_{max}(d, q) = -(\log_2 \Delta + \log_2 N) \quad (8)$$

The robustness index,  $RS_I$ , is defined as the fractional differences between  $H_{max}(d, q)$  and  $H(d, q)$ , which can be expressed by the following equation:

$$RS_I = \frac{H(d, q)}{H_{max}(d, q)} \quad (9)$$

Our robustness index combines both the degree distribution and the demand fraction and can be obtained by substituting Eq. (2), Eq. (5) and Eq. (8) into Eq. (9) as:

$$RS_I = \frac{\sum_{k=1}^{\Delta} g_k \log_2(g_k) + \sum_{i=1}^N \left(\frac{Q_i}{Q_t}\right) \log_2\left(\frac{Q_i}{Q_t}\right)}{\log_2 \Delta + \log_2 N} \quad (10)$$

The robustness index proposed here is the ratio of the network robustness to the maximum possible robustness, which describes the distance to the degree of severity of failures in the network, due to the failure of each individual node.  $RS_I$  falls within the range of [0,1] and satisfies the following properties:

- 1)  $RS_I$  is a dimensionless value, which implies the relative entropy.
- 2) When  $RS_I$  is closer to 1 the robustness is higher, and otherwise is smaller.
- 3)  $RS_I$  attains its maximum value ( $RS_I = 1$ ) when  $\{g_k = \frac{1}{\Delta} : k = 1, 2, \dots, \Delta\}$  and  $\{p_i = \frac{Q_i}{Q_t} : i = 1, 2, \dots, N\}$ .

## 2.4. A summary of the research design

This research maps a WDN into a graph of nodes and edges. The edges of the graph represent the pipes of a WDN and nodes represent the demand nodes through which water is supplied to the consumers. Each node in the graph is associated with its degree as well as its required flow. The contribution of a node  $i$  to the robustness of the network is first estimated by calculating the degree of the node ( $k$ ) along with the relative importance of the node to the total required water for the network ( $p_i$ ). The diversity in degree distribution as a proxy to estimate the topological diversity of the network is then measured by calculating the entropy of the probability distribution of the fraction of nodes with various degrees ( $g_k$ ) by using Eq. (2). In a similar vein, the entropy of the set of demand fraction values is calculated by using Eq. (5). We then proceed with evaluating the joint consideration of the topological and hydraulic robustness of the network. The robustness of the network as a whole is obtained from the joint entropy of a combination of the entropy degree distribution and demand fraction by using Eq. (7). Finally, the robustness index ( $RS_I$ ) is constructed based on the fractional differences between the joint entropy and the maximum achievable entropy using Eq. (10). The elaborated structure of the proposed method is demonstrated on a real-world case study in the following section.

## 3. Application

In order to compute the value of the robustness index, discussed in section 2, it is now time to turn to a real-world WDN of Bordertown, an Australian town supplying 2800 inhabitants in South Australia near the Victorian border (Fig. 1). The data for this research has been obtained from the official website of SA Water, containing the layout of the network, pipes diameter, and the number of households connected to each pipe (<http://sawater.maps.arcgis.com>). The example network is mapped into a graph with 216 nodes, representing demand nodes, and 256 edges, representing pipes varying from 80 mm to 375 mm.



Figure 1. Bordertown water distribution network

Results from the application of the proposed method to data from the case study are now presented. We start with computing the entropy of degree distribution ( $H_d$ ) and then proceed with obtaining the demand fraction entropy ( $H_q$ ). The robustness index ( $RS_I$ ) is finally developed using the values of  $H_d$ ,  $H_q$ , and the maximal entropy.

The parameters used for computing  $H_d$  are listed in Table. 1.

Table 1. The parameters used for obtaining  $H_d$

$k$	$n_k$	$g_k = \frac{n_k}{N}$	$\log(g_k)$	$g_k \log(g_k)$
1	74	0.3426	-1.5454	-0.5295
2	25	0.1157	-3.1110	-0.3601
3	84	0.3889	-1.3626	-0.5299
4	33	0.1528	-2.7105	-.04141

By substituting the results from Table 1 into Eq. (2),  $H_d = 1.8335$  bits.

A similar procedure can be used for calculation of  $H_q$ . Due to a large number of nodes, Table 2 shows a part of the parameters used for calculating  $H_q$  representatively.

Table 2. Some of the parameters used for obtaining  $H_q$

Node	$p_i = \frac{q_i}{Q_t}$	$\log\left(\frac{q_i}{Q_t}\right)$	$\frac{q_i}{Q_t} \log\left(\frac{q_i}{Q_t}\right)$
1	0.00154	-9.3469	-0.01435
2	0.00154	-9.3469	-0.01435
3	0.00307	-8.3469	-0.02564
4	0.00324	-8.2689	-0.02681
:	:	:	:
105	0.00234	-8.7392	-0.02045
106	0.00586	-7.4153	-0.04344
:	:	:	:
215	0.00341	-8.1949	-0.02797
216	0.00171	-9.1949	-0.01569

By using Eq. (5),  $H_q = 7.5604$  bits.

Given  $\Delta = 4$  and  $N = 216$ , now is possible to calculate the robustness index of the example network, using Eq. (10), that is,  $RS_I = 0.9630$ .

$RS_I$  can be interpreted as a measure of distance from the maximum possible entropy of the network. The high value of  $RS_I$  in the example network implies low heterogeneity and subsequently high level of serviceability in the case of random failure of a node.

For completeness, the results of this analysis are summarized in Table 3.

Table 3. The number of nodes, maximum nodal degree, the entropy of degree distribution, the entropy of demand fraction, robustness index.

$N$	$\Delta$	$H_d$	$H_q$	$H_{max}(d, q)$	$RS_I$
216	4	1.8335	7.5604	9.7546	0.9630

#### 4. Discussion

We now compare a few key characteristics of nodal degree distribution and demand fraction concepts. Visualizations underlying the value of  $RS_I$  are also presented here.

Fig. 2(a) shows the degree of nodes in the example network. A low diversity of the node degrees is observed such that the maximum degree is four. Consequently, only four points can be considered for obtaining the degree distribution entropy. Fig. 2(b) depicts the density against the nodal degree. The nodes have a maximum of 4 links and a minimum of one link. Degree 3 and 1 nodes are the most occurring degrees in the network, whereas degree 2 and 4 are the less frequent degrees. As expected for a real-world WDN, a low heterogeneity of the nodal degree values was observed. This result is consistent with the two well-known facts. First, for WDNs, the nodal degree distribution spans over a very limited range (in this case from, 1 to 4). Second, the maximum nodal degree for WDNs is generally very low (Giustolisi *et al.*, 2016) and therefore yields insufficient information for measuring the robustness of a WDN.

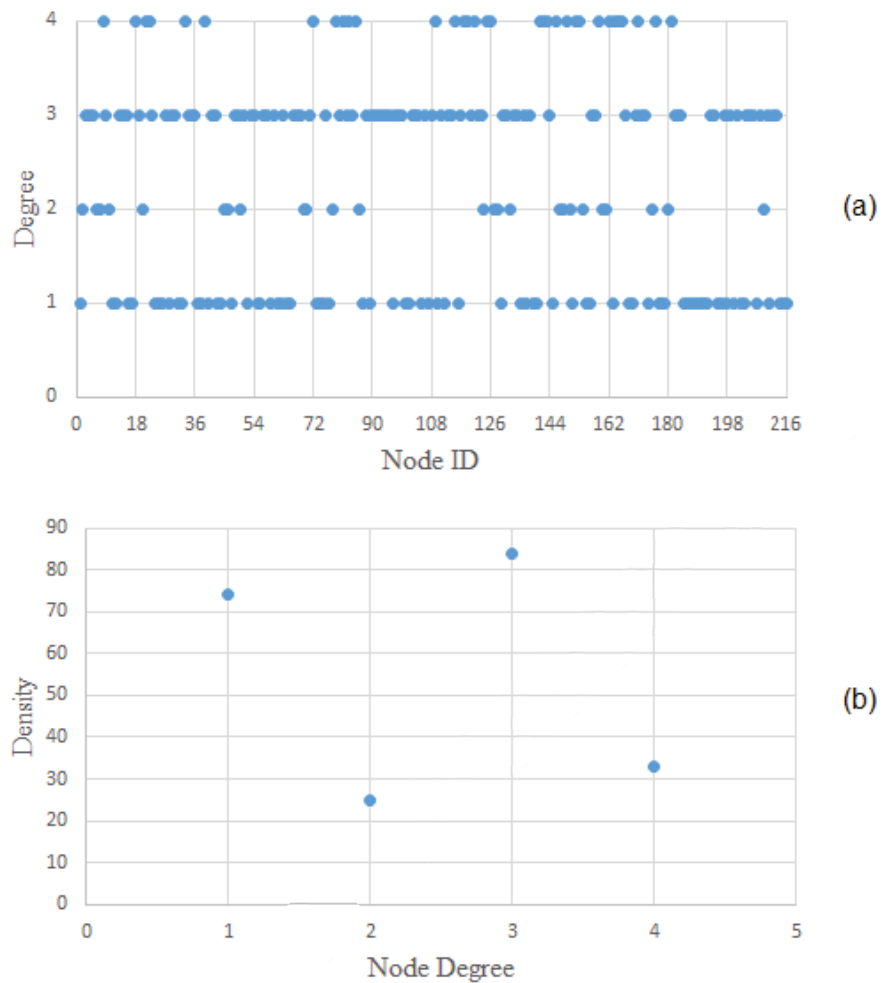


Figure 2. (a) Degree of each node; (b) Nodal degree distribution of the example network

By contrast, as reported in Fig. 3(a), the demand fractions span a wider range of values, ranging from 0.00068 to 0.01501. As discussed in the preceding section, incorporating more variables into the probabilistic model entails a more reliable estimation of the robustness. Moreover, as shown in Fig. 3(b), it is observed that the density values are more frequent around the corresponding value of the uniformed demand distribution, that is,  $\frac{1}{N} = 0.0046$ , which implies homogeneity of the network from the demand distribution perspective.

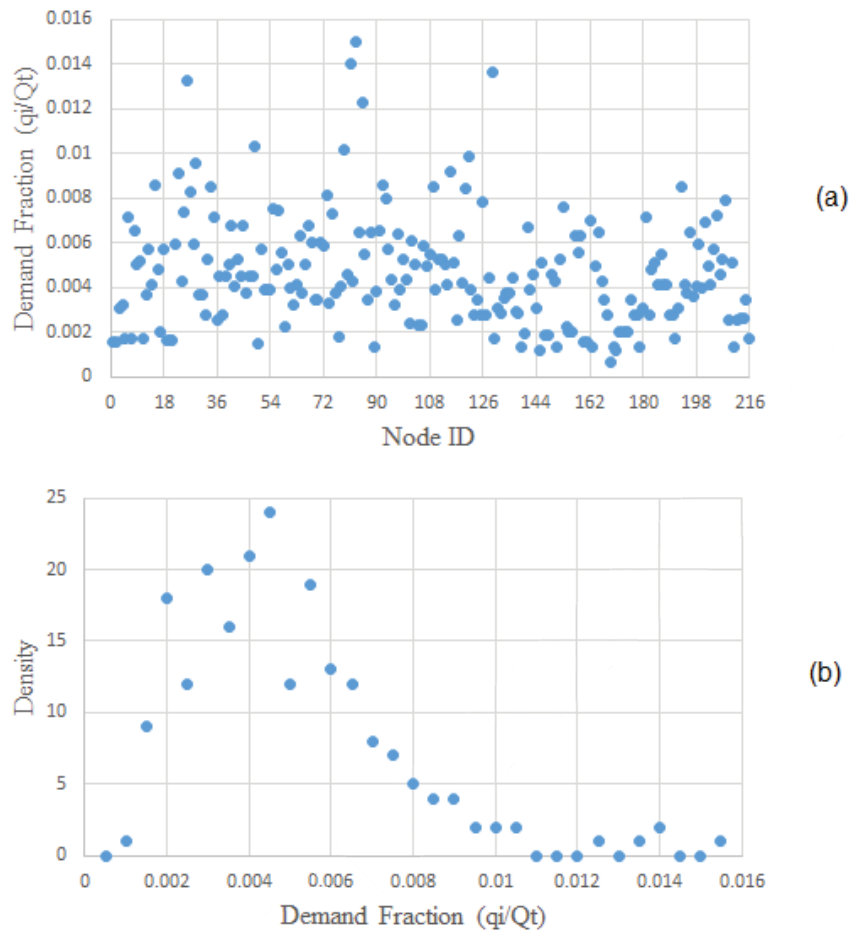


Figure 3. (a) Demand fraction of each node; (b) Demand fraction distribution of the case study

Fig.3 (a) plots the scatterplot of  $p_i$ , illustrating the level of heterogeneity in the network. As Giustolisi *et al.*, (2008) put forward, the fraction of unsupplied demand is a good indicator of the overall network performance. Thus, the demand fraction can be interpreted as a measure for the loss of the network performance when a node is failed. As shown in Fig. 3(a), the loss of performance oscillates between 0.07% and 1.5%. In terms of the demand fraction values, the nodes can be broadly grouped as follows. The nodes with  $p_i > 0.01$ , whose failures lead to more than 1% loss of the network performance and the nodes with  $p_i < 0.01$ , whose failures result in less than 1% loss in the network performance. The single failure of 209 out of 216 nodes in the network (the latter group), results in loss of overall performance at values of less than 1%, thereby confirming low heterogeneity of the studied network. More precisely, the removal of nodes 26, 49, 79, 81, 83, 85, and 129 with relatively large values of  $p_i$  will have more consequences on the network performance. In the other words, failure of these seven nodes accounts for 8.87% loss of the network performance.

As above discussion attests, the high value of  $RS_f = 0.963$  is not entirely surprising and, indeed this value supports the fact that the Bordertown WDN is a spatially organized network with low heterogeneity, where most of the nodes have comparable influence form the degree and the demand perspectives. In fact,  $RS_f$  measures the degree of operability of the network due to the failure of each individual nodes. The larger  $RS_f$  the lesser the consequences of the nodal failure on the network performance.

## 5. Conclusion

The method described herein represents a new step toward measuring the robustness of WDNs. The authors advocate the idea that the behavior of a network can be characterized by assessing the influence of each individual node in the network (Singh *et al.*, 2015). Different authors have developed either topological perspectives or hydraulic methods to evaluate the robustness of WDNs. The present research emphasizes that persistent focus on topological properties or exclusive emphasis on hydraulic attributes of WDNs fails to realistically measure the robustness. To remedy this weakness, rooted in entropy theory, a new robustness index is proposed, which combines the topological and hydraulic attributes of the network. The proposed index not only explores the structural heterogeneity of the network by using an entropy-based degree distribution metric, but also incorporates the demand fraction entropy that accounts for the hydraulic attribute of WDNs. This integrated approach yields more useful insights to evaluate the robustness of WDNs in comparison with the conventional approaches.

The paper posits the informational entropy theory as a tool to measure the robustness of WDNs. The work also measures and analyses the robustness of a network from the character of its heterogeneity (Wang *et al.*, 2006). On this premise, the joint entropy of degree distribution and demand fraction is employed to measure the network's heterogeneity, which in turn can be interpreted as the measure of robustness. The entropy-based analysis reveals that a uniform demand distributed network with diversity in its degree distribution is less heterogeneous and thus exhibits more robust behavior against the random failure of its nodes.

The use of the proposed index was illustrated with a real-world case study. The paper compared the effectiveness of the demand fraction entropy-based metric with the degree distribution entropy-based metric. The numerical results confirmed that the nodal degrees in WDNs span over a small range of values, consequently the degree distribution entropy-based metric is not informative enough and therefore the stand-alone use of this metric hinders a reliable assessment of the robustness in WDNs (Giustolis *et al.*, 2017).

Two practical implications can be drawn from the robustness analysis method proposed in this research. First, the model developed in this work helps the water utilities to design an effective risk mitigation plan by eliciting the knowledge about how the network continues to perform after failures of its individual nodes. Second, the model can be used as a complement to the conventional reliability based maintenance models by means of measuring the degree of consequences of the nodal failures in WDNs.

The current study is not exempt from limitations. Water demand is a non-stationary attribute that changes over time. The proposed robustness index provides a snapshot of the network at a particular point in time. Therefore, as suggested by Zarghami *et al.*, (2018b), there is a need for a complementary approach (e.g., system dynamics) to design a model that can be updated as the nodal water demands change over time. Furthermore, though the degree distribution and demand fraction are good indicators of the topological and the hydraulic (respectively) performance of WDNs, these metrics do not entirely characterize the structural and hydraulic behaviors of the network. Further research can build upon our current study by incorporating more topological (e.g. centrality measures) as well as hydraulic (e.g. pressure head at nodes) metrics into our method. We believe that the robustness evaluation of WDNs requires incorporating more factors than is presented in this paper and hope the current study further encourages researchers to develop more innovative methods.

## References

- Agathokleous, A., Christodoulou, C., Christodoulou, SE., Topological robustness and vulnerability assessment of water distribution networks, *Water Resource Management*, pp. 1-15, 2017.
- Agudelo-Vera, C., Blokker, M., Vreeburg, J., Bongard, T., Hillegers, S., Van Der Hoak, JP., Robustness of drinking water distribution networks under changing failure demand, *Procedia Engineering*, vol. 89, pp. 339-346, 2014.
- Awumah, K., Goulter, I., Bhatt, SK., Entropy-based redundancy measures in water distribution networks. *Journal of Hydraulic Engineering*. vol. 117, no. 5, pp. 595-614, 1991.
- Carlson, JM., Doyle, J, Complexity and robustness *Proceedings of the National Academy of Sciences of the United States of America*, vol. 99, pp. 2538-2545, 2006.
- Cuadra, L., Salcedo-Sanz, S., Del Ser, J., Jimenez-Fernandez, S., Geem, ZM., A critical review of robustness in power grids using complex networks concept, *Energies*, vol. 8, no. 9, pp. 9211-9265, 2015.
- Ferrario, E., Pedroni, N., Zio, E., Evaluation of the robustness of critical infrastructures by hierarchical graph representation, clustering and Monte Carlo simulation, *Reliability Engineering and System Safety*, vol. 155, pp. 78-96, 2016.



- Giustolisi, O., Kapelan, Z., Savic, D., Extended period simulation analysis considering valve shutdowns, *Journal of Water Resources Planning and Management*, vol. 134, no. 6, pp. 527-537, 2008.
- Giustolisi, O., Simone, A., Ridolfi, L., Classification of infrastructure networks by neighbourhood degree distribution, *arXiv preprint arXiv: 1609.07580*, 2016.
- Giustolisi, O., Simone, A., Ridolfi, L., Network classification and features of water distribution systems, *Water Resources Research*, vol. 53, no. 4, pp. 3407-3423, 2017.
- Greco, R., Di Nardo, A., Santonastaso, G., Resilience and entropy as indices of robustness of water distribution networks. *Journal of Hydroinformatics*, vol. 14, no. 3, pp. 761-771, 2012.
- Gunawan, I., Schultmann, F., Zarghami, SA., The four Rs performance indicators of water distribution networks: A review of research literature, *International Journal of Quality & Reliability Management*, vol. 34, no. 5, pp. 720-732, 2017.
- Iyer, S., Killingback, T., Sundaram, B., Wang, Z., Attack robustness and centrality of complex networks, *PLoS ONE*, vol. 8, no. 4, e59613, 2013.
- Jiang, Y., Hu, AQ., Song, YB, The evaluation of complex networks' robustness based on entropy measure. In *Communications Security Conference*, pp. 1-5, 2014.
- Jung, D., Kang, D., Kim, JH., Lansey, K., Robustness-based design of water distribution networks, *Journal of Water Resources Planning and Management*, vol. 140, no. 11, pp. 04014033:1-14, 2014.
- Li, C., Singh, VP., Mishra, AK., Entropy theory-based criterion for hydrometric network evaluation and design: Maximum information minimum redundancy, *Water Resource Research*, vol. 48, no. 5, W05521:1-15, 2012.
- Li, P., Wang, BH., Sun, H., Gao, P., Zhou, T., A limited resource model of fault-tolerant capability against cascading failure of complex networks, *The European Physical Journal B*, vol. 62, no. 1, pp. 101-104, 2008.
- Lin, Y., Desouza, KC., Roy, S., Measuring agility of networked organizational structure via network entropy and mutual information, *Applied Mathematics and Computation*. vol. 216, no.10, pp. 2824-2836, 2010.
- Pozrikidis, C., Node degree distribution in spanning trees, *Journal of Physics A: Mathematical and Theoretical*. vol. 49, no.12, p. 125101, 2016.
- SA Water, *Water Mains Replacement Program*, viewed 15<sup>th</sup> August 2017, <http://sawater.maps.arcgis.com/apps/View/index.html?appid=afdd0293e7834256beb889b205f8b830>,
- Sato, JR., Takahashi, DY., Hoexter, MQ., Massirer, KB., Fugita, A., Measuring network's entropy in ADHD: a new approach to investigate neuropsychiatric disorders, *NeuroImage*, vol. 77, pp. 44-51, 2013.
- Schieber, TA., Carpi, L., Frery, AZ., Rosso, OA., Pardalos, PM., Ravetti, MG., Information theory perspective on network robustness, *Physics Letters A*, vol. 380, no. 3, pp. 359-364, 2016.
- Singh, P., Chakraborty, A., Manoj, BS., Link influence entropy, *Physica A: Statistical Mechanics and its Applications*, vol. 465, pp. 701-713, 2017.
- Singh, VP., *Entropy Theory and its Application in Environmental and Water Engineering*. Wiley-Blackwell, New York, USA, 2013.
- Shannon, CE., A mathematical theory of communication, *Bell System Technical Journal*, vol.27, no.3, pp. 379-423, 1948.
- Sole, RV., Valverde, S., Information theory of complex networks: On evolution and architectural constraints, In *Complex Networks*, pp. 189-207, Springer, Berlin, Heidelberg, 2004.
- Tanyimboh, TT., Informational entropy: A failure tolerance and reliability surrogate for water distribution networks. *Water Resources Management*. , vol. 31, no. 10, pp. 3189-3204, 2017.
- Wang, B., Tang, H., Guo, C., Hio, C., Zhou, Entropy optimization of the scale-free networks' robustness to random failure, *Physica A: Statistical Mechanics and its Applications*, vol. 36, no. 2, pp. 591-296, 2006.
- Wang, X., Pourmaras, E., Kooij, RE., Van Mieghem P., Improving robustness of complex networks via the effective graph resistance, *The European Physical Journal B*, vol. 87, no. 9, pp. 1-12, 2014.
- Wu, J., Tan, YJ., Deng, HZ., Zhu, DZ., Heterogeneity of scale-free networks, *Systems Engineering-Theory& Practice*, vol. 27, no. 5, pp. 101-105, 2007.
- Wu, L., Tan, Q., Zhang, Y., Network connectivity entropy and its application on network connectivity reliability, *Physica A: Statistical Mechanics and its Applications*, vol. 392, no. 21, pp. 5536-5541, 2013.
- Yazdani, A., Jeffrey, P., Complex network analysis of water distribution systems, *Chaos: An Interdisciplinary Journal of Nonlinear Science*, vol. 21, no. 1, p. 016111, 2011.
- Yazdani, A., Jeffrey, P., Applying network theory to quantify the redundancy and structural robustness of water distribution systems, *Journal of Water Resource Planning and Management*, vol. 138, no. 2, pp. 153-161, 2012 a.
- Yazdani, A., Jeffrey, P., Water distribution system vulnerability analysis using weighted and directed network models, *Water Resource Research*, vol. 48, no. 6, 2012 b.

- Yazdani, A., Otoo RA., Jeffrey, P., Resilience enhancing expansion strategies for water distribution systems: A network theory approach, *Environmental Modelling & Software*, vol. 26, no. 12, pp. 1574-1582, 2011.
- Zarghami, SA., Gunawan I., Schultmann, F., Integrating entropy theory and cospanning tree technique for redundancy analysis of water distribution networks, *Reliability Engineering and System Safety*, vol. 176, pp. 102-112, 2018 a.
- Zarghami, SA., Gunawan I., Schultmann, F., System dynamics modelling process in water sector: a review of research literature, *System Research and Behavioral Science*, In press.

## Biographies

**Seyed Ashkan Zarghami** is a PhD candidate in Faculty of Professions at the University of Adelaide, Australia. He is currently researching on complex systems. He holds a Bachelor's degree in civil engineering, Master's degrees in project management and civil & structural engineering. Prior to his doctoral studies, he worked for several years in water sector and infrastructure projects.

**Indra Gunawan** is Associate Professor in Complex Project Management and Director of Project Management Program in the Entrepreneurship, Commercialisation and Innovation Centre at the University of Adelaide, Australia. He received his PhD in Industrial Engineering and MSc in Construction Management from Northeastern University, USA. His current research interests include system reliability modelling, maintenance optimisation, project management, applications of operations research, and operations management. His work has appeared in many peer-reviewed journals and conference proceedings.

**Frank Schultmann** holds a Professorship of Business Administration at the Karlsruhe Institute of Technology (KIT) and is director of the KIT's Institute for Industrial Production (IIP) and the KIT's French-German Institute for Environmental Research (DFIU). He is also Professor of Complex Project Management for the University of Adelaide. He completed his doctoral thesis in 1998 and his Habilitation in 2003 at the Faculty of Economics and Business Engineering at the University of Karlsruhe (now KIT). Prior to his present positions he was Professor of Industrial Management at the University of Koblenz-Landau and holder of the Chair of Business Administration, Construction Management and Economics at the University of Siegen. His research interests include sustainable production and logistics, decision support, supply chain management and optimization, systems engineering, project management, technology assessment, construction management, and information and communication technologies.

**7.2. Paper 8: A domain-specific measure of centrality for water distribution networks**

## Statement of Authorship

Title of Paper	A Domain-Specific Measure of Centrality for Water Distribution Networks		
Publication Status	<input checked="" type="checkbox"/> Published	<input type="checkbox"/> Accepted for Publication	
	<input type="checkbox"/> Submitted for Publication	<input type="checkbox"/> Unpublished and Unsubmitted work written in manuscript style	
Publication Details	Zarghami S.A., and Gunawan, I. (2019). Demand Centrality Measure: A Domain-Specific Measure of Centrality for Water Distribution Networks. <i>Engineering, Construction and Architectural Management</i> . DOI: <a href="https://doi.org/10.1108/ECAM-03-2019-0176">https://doi.org/10.1108/ECAM-03-2019-0176</a> .		

### Principal Author

Name of Principal Author (Candidate)	Seyed Ashkan Zarghami		
Contribution to the Paper	Design the model and computational framework- Developing the theory- Proposing a new method- Performing the analytic calculations- Demonstrating the proposed method on case studies-Discussion of results- Identifying avenues for future work- Writing the manuscript		
Overall percentage (%)	85%		
Certification:	This paper reports on original research I conducted during the period of my Higher Degree by Research candidature and is not subject to any obligations or contractual agreements with a third party that would constrain its inclusion in this thesis. I am the primary author of this paper.		
Signature		Date	08/08/19

### Co-Author Contributions

By signing the Statement of Authorship, each author certifies that:

- i. the candidate's stated contribution to the publication is accurate (as detailed above);
- ii. permission is granted for the candidate to include the publication in the thesis; and
- iii. the sum of all co-author contributions is equal to 100% less the candidate's stated contribution.

Name of Co-Author	Associate Professor Indra Gunawan		
Contribution to the Paper	Supervising development of the work- Verifying the numerical results- Evaluation of the manuscript- Helping to edit the manuscript-Final approval of the version to be published		
Signature		Date	8/8/19

Name of Co-Author			
Contribution to the Paper			
Signature		Date	

Please cut and paste additional co-author panels here as required.

# A domain-specific measure of centrality for water distribution networks

Seyed Ashkan Zarghami and Indra Gunawan  
*Entrepreneurship, Commercialisation and Innovation Centre (ECIC),  
Faculty of Professions, University of Adelaide, Adelaide, Australia*

A domain-specific  
measure of  
centrality

Received 31 March 2019  
Revised 29 May 2019  
21 June 2019  
Accepted 30 June 2019

## Abstract

**Purpose** – In recent years, centrality measures have been extensively used to analyze real-world complex networks. Water distribution networks (WDNs), as a good example of complex networks, exhibit properties not shared by other networks. This raises concerns about the effectiveness of applying the classical centrality measures to these networks. The purpose of this paper is to generate a new centrality measure in order to stick more closely to WDNs features.

**Design/methodology/approach** – This work refines the traditional betweenness centrality by adding a hydraulic-based weighting factor in order to improve its fit with the WDNs features. Rather than an exclusive focus on the network topology, as does the betweenness centrality, the new centrality measure reflects the importance of each node by taking into account its topological location, its demand value and the demand distribution of other nodes in the network.

**Findings** – Comparative analysis proves that the new centrality measure yields information that cannot be captured by closeness, betweenness and eigenvector centrality and is more accurate at ranking the importance of the nodes in WDNs.

**Practical implications** – The following practical implications emerge from the centrality analysis proposed in this work. First, the maintenance strategy driven by the new centrality analysis enables practitioners to prioritize the components in the network based on the priority ranking attributed to each node. This allows for least cost decisions to be made for implementing the preventive maintenance strategies. Second, the output of the centrality analysis proposed herein assists water utilities in identifying the effects of components failure on the network performance, which in turn can support the design and deployment of an effective risk management strategy.

**Originality/value** – The new centrality measure, proposed herein, is distinct from the conventional centrality measures. In contrast to the classical centrality metrics in which the importance of components is assessed based on a pure topological viewpoint, the proposed centrality measure integrates both topological and hydraulic attributes of WDNs and therefore is more accurate at ranking the importance of the nodes.

**Keywords** Betweenness centrality, Centrality measures, Closeness centrality, Demand centrality, Eigenvector centrality, Percolation centrality, Water distribution networks

**Paper type** Research paper

## 1. Introduction

Water distribution networks (WDNs) are among the critical infrastructures, which are central to the functionality of cities. These networks dictate the living and working conditions of urbanities (Etezadzadeh, 2016). However, WDNs are confronted with numerous operational threats that lead to disruption and dysfunction of their performance. Failure of any critical component of WDNs has a significant impact on public health, safety, customer satisfaction, security, social well-being and economy (Gunawan *et al.*, 2017). As a response to the growing operational dysfunctions, much attention has been paid to meet the operational objectives of these networks (Xuan My Tran *et al.*, 2003). As a result, researchers have recognized the importance of identifying vulnerabilities and prioritizing components for reliability improvement and protection of these systems (Gertsbakh and Shpungin, 2011).

Much effort has been devoted to the development of a vast array of methods for vulnerability analysis of WDNs. Yazdani and Jeffrey (2012) proposed a demand-adjusted entropic measure to quantify the vulnerability of WDNs. Shuang *et al.* (2014) measured the pressure in nodes as well as the flows in pipes during the cascading process with the aim of



---

evaluating the nodal vulnerability of WDNs under cascading failure. Fragiadakis and Christodoulou (2014) and Fragiadakis *et al.* (2016) performed a seismic hydraulic vulnerability assessment of urban water networks using survival analysis. Laucelli and Giustolisi (2015) evaluated the vulnerability of WDNs under seismic actions using a hydraulic modeling paradigm by considering unsupplied demand to customers. Shuang *et al.* (2017) identified the vulnerable pipes in WDNs through the evaluation of system reliability by focusing on the balance of water supply and demand. Maiolo *et al.* (2018) evaluated the vulnerability by measuring the significance of the demand deficit during pipe failures in WDNs.

Early in this century, researchers began to look at the various performance indicators of WDNs such as resilience, redundancy and robustness as indirect measures of vulnerability. In this context, network analysis has become a premier approach to identifying vulnerabilities by quantifying these performance indicators. Network science employs the quantitative graph theory to analyze the structural information of networks (Dehmer *et al.*, 2017). Michaud and Apostolakis (2006) proposed a graph theory-based network analysis algorithm for ranking the elements of WDNs. Pinto *et al.* (2010) developed a clustering process for structural vulnerability analysis of WDNs by assessing the connectivity and the condition of pipelines in the network. Candelieri *et al.* (2015) proposed a graph clustering approach to identify the degree to which a WDN is resilient. Herrera *et al.* (2016) developed a graph theoretic framework for assessing the resilience of WDNs based on quantifying the redundancy of the networks. A network theory measure known as betweenness centrality was adopted in the work of Agathokleous *et al.* (2017) to develop a vulnerability assessment model for WDNs. Di Nardo *et al.* (2017) used graph theory quantities to identify the redundancy properties of WDNs with the goal of evaluating the reliability and robustness of the networks. Giudicianni *et al.* (2018) compared and contrasted the use of different graph theory metrics to quantify the general topological characteristics of WDNs. Robustness of WDNs was evaluated in the work of Di Nardo *et al.* (2018) by using a set of graph spectral techniques to measure the strength of network connectivity. Pagano *et al.* (2018) suggested a graph theory-based multi-dimensional framework consists of a set of attributes such as robustness and redundancy for resilience analysis of WDNs. Zarghami *et al.* (2018a) developed a graph theory-based framework to evaluate the local and global redundancy of WDNs as a surrogate method for vulnerability analysis. Meng *et al.* (2018) examined the effect of different topological attributes of WDNs on resilience performance.

As the literature review revealed, research on vulnerability analysis of WDNs is embedded in capturing either the hydraulic attributes of WDNs or the topological properties of these networks. On one hand, an exclusive focus on hydraulic analysis yields insufficient information in relation to critical locations as well as various levels of interdependency among the network components. On the other hand, the stand-alone use of the topological approach does not account for flow and pressure distribution in WDNs. More specifically, graph theory quantities mainly focus on the topological attributes of the networks such as path lengths and distances (Muric *et al.*, 2016). In a dynamic setting such as a WDN, the topological measurements alone only partially describe the network structure and cannot entirely characterize its properties (Yazdani *et al.*, 2011). In fact, these metrics are mainly concerned with the importance of a node from a topological point of view, as such, in the case of weighted networks, where an attribute is used to weight different nodes, these metrics are not effective (Candeloro *et al.*, 2016). In order to provide a comprehensive picture of the network operability, a different approach that integrates topological and hydraulic attributes seems a more effective method for vulnerability analysis of WDNs. This integrated approach is missing in the existing literature. In this respect, this work adopts water demand, which is the driving force behind the hydraulic dynamics occurring in WDNs, as a weighting factor for assessing the centrality of a node. Moreover, the temporal behavior of the demand nodes in the network necessitates designing a new metric that can

---

be updated as the nodal demands change over time. Therefore, the importance of each path in a WDN measured by centrality analysis, not only depends on the state of different nodes in the network but also changes over time (Zarghami *et al.*, 2018b). With these imperatives in mind, this paper proposes a new centrality measure, termed demand centrality, which realistically assesses the importance of nodes in the network at any given time. The new centrality metric integrates the topological and hydraulic attributes of WDNs, which is designed as a living entity that can be updated as the nodal demand changes over time.

The key contribution this study makes is to develop a domain-specific centrality metric that evaluates the importance of each node in a WDN with respect to its topological location along with its required demand at any given point in time. This is accomplished by assigning a weighting factor to a junction node. The weighting factor not only comprises of the relative value of the nodal demand at any given time but also takes into account the distribution of the nodal demands around the source node. This paper also makes a contribution by way of differentiating between the source and sink nodes and thereby offering a new way of counting the number of shortest paths.

The outline of this paper is as follows. Basic definitions of the three most commonly used centrality measures as well as their applications to real-world networks are presented in Section 2. Section 3 develops the new centrality measure for WDNs. Section 4 briefly outlines the procedural steps to apply the proposed centrality analysis method. As an illustrative example, a real-type WDN is analyzed in Section 5, using the proposed centrality measure. Section 6 is devoted to the discussion of the numerical results followed by a comparison of the new metric with the classical centrality measures. Section 7 presents the practical implications of the research. The paper is concluded in Section 8 and possible avenues for future work are outlined in the end.

## 2. Centrality measures

The extent to which a component influences the network is often quantified by graph theory quantities known as centrality measures. Centrality measures have been recognized as a cornerstone to investigate the impact of individual components on network performance. Accordingly, a great many measures of centrality has been devised since the 1940s as a fundamental tool to evaluate the importance of a node or an edge in a network with respect to given network performance.

The existing centrality measures can be broadly categorized into three groups: geometric, spectral and path-based metrics. Geometric metrics are based on assessing the importance of an element as a function of its distance to other elements in the network. Spectral metrics compute the left dominant eigenvector of a network adjacency matrix as a measure of importance. Path-based metrics count the number of paths passing through a component as a measure to assess the extent to which the component is central.

In order to demonstrate the effectiveness of demand centrality, this work compares the new centrality measure with exemplary centrality metrics from each of the aforementioned groups. These metrics are: closeness centrality as a geometric metric, betweenness centrality as a path-based metric and eigenvector centrality as a spectral metric.

### 2.1 Closeness centrality

Closeness centrality measures a mean distance from a given node to other nodes in a network. It was first introduced by Bavelas (1950) based on the idea that a node with a short geodesic distance from other nodes in a task-oriented group can communicate better for delivering its message throughout the network. Figure 1 shows an example of a node with a high closeness centrality. As can be seen, Node 6 has the highest value of closeness centrality because the mean distance from this node to all other nodes in the network is relatively low.

Closeness centrality can be stated by the following formula:

$$C_C(i) = \frac{n-1}{\sum_j d_{ij}}, \tag{1}$$

where  $C_C(i)$  represents the closeness centrality,  $n$  is the number of nodes in the network and  $d_{ij}$  denotes the shortest path lengths between node  $i$  and  $j$ .

2.2 Eigenvector centrality

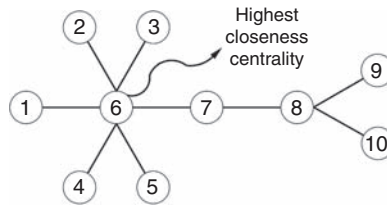
Eigenvector centrality of a node is measured based on the concept that the node centrality is proportional to the combined centrality values of its neighbors. For a given node, connecting to many nodes with high eigenvector centrality contributes more to the eigenvector centrality of the node (Parand *et al.*, 2016; Fletcher and Wennekers, 2017). For example, as can be seen in Figure 2, Node 9 has the highest value of eigenvector centrality. This can be attributed to the importance of the immediate neighbors of this node (Nodes 4, 8 and 12).

Eigenvector centrality can be formulated as follows:

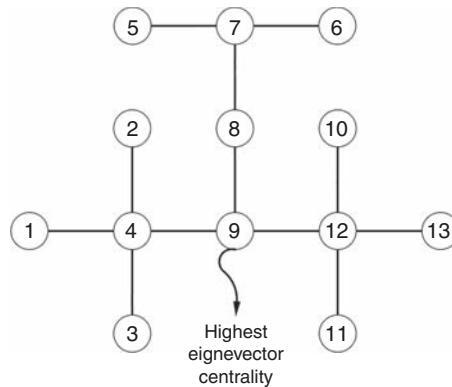
$$\begin{aligned} C_E(i) &= \frac{1}{\lambda} \sum_{j \rightarrow i} C_e(j), \\ \lambda e &= Ae \end{aligned} \tag{2}$$

where  $A$  is the adjacency matrix,  $e$  denotes the eigenvector centrality of all nodes and  $\lambda$  is the largest eigenvector of the adjacency matrix.

**Figure 1.**  
Example of a node with a high closeness centrality



**Figure 2.**  
Example of a node with a high eigenvector centrality



### 2.3 Betweenness centrality

Betweenness centrality quantifies the power of a node in controlling over pair-wise connections between other nodes in the network (Brandes, 2008) and measures the influence of a particular node on the connection between other pairs of nodes in a network (Bell, 2014). Betweenness centrality is based on the gist that a node is central if it is located on many shortest paths connecting pairs of nodes. Figure 3 depicts an example network in which Node 5 has the highest betweenness centrality value. This is because a high number of shortest paths passes through this node.

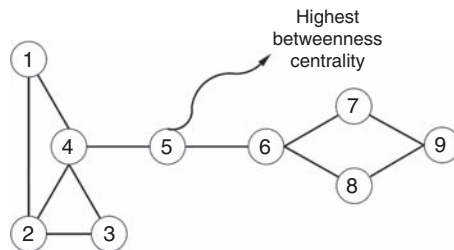
Betweenness centrality can be expressed by the following equation:

$$C_B(i) = \frac{1}{(n-1)(n-2)} \sum_{s \neq r \neq i} \frac{n_{s,r}(i)}{n_{s,r}}, \quad (3)$$

where  $n$  is the number of nodes in the network,  $n_{s,r}(i)$  denotes the number of shortest paths between  $s$  and  $r$  passing through  $i$  and  $n_{s,r}$  represents the number of shortest paths between  $s$  and  $r$ .

Centrality analysis is now considered as a common tool to evaluate the importance of elements in real-world complex networks by measuring the various network topology, described above. Geffre *et al.* (2009) used eigenvector centrality to identify the critical members of a terrorist network. Joyce *et al.* (2010) performed centrality analysis to study the function of the human brain as a network of interconnected components. Neal (2011) identified the importance of cities in world city networks by adopting a number of centrality measures. Zio and Piccinelli (2010) developed a modified centrality metric for analyzing electrical power transmission networks. Piraveenan *et al.* (2013) proposed an adjusted betweenness centrality metric, called percolation centrality, which accounts for the interplay between topology and function of networks. The intuitive conception of the percolation centrality is based upon the idea that the value of a node depends on the state of the node as well as other nodes within a network. Grunspan *et al.* (2014) employed betweenness centrality to analyze social interactions between students. Klimek *et al.* (2016) conducted centrality analysis for citation networks by ranking documents based on their potential impact. Zhao *et al.* (2017) proposed a modified centrality measure to analyze urban traffic flow. Honglu *et al.* (2018) analyzed vulnerabilities in the maritime supply chains by applying various centrality measures including betweenness and closeness centrality. Zarghami *et al.* (2019) adopted betweenness, closeness, and eigenvector centrality to identify the importance of components in WDNs. Brysbaert *et al.* (2019) studied the function of a protein by using betweenness and closeness centrality.

Although the centrality metrics cited above have been successfully developed and applied for the purpose of ranking the importance of elements in various real-world networks, these measures lack the capability of achieving a closer adherence to WDNs. Indeed, these methods ignore the valuable hydraulic properties of WDNs such as water demand. An attempt is made in the following section to provide a solution to this problem by developing a new centrality measure, which is specifically tied to the WDN field.



**Figure 3.**  
Example of a node with a high betweenness centrality



### 3. Demand centrality

WDNs exhibit properties such as the hydraulic attributes that are not shared by other networks. This raises concerns about the effectiveness of applying the classical centrality measures to this domain. This section attempts to capture the interplay between topology and hydraulic by developing a new centrality measure. In order to follow this research line, the traditional betweenness centrality is refined by adding a weighting factor. This weighting factor accounts for water demand as the key hydraulic characteristic of WDNs at any given time. Rather than an exclusive focus on the network topology, as does the betweenness centrality, the new centrality measure, termed demand centrality, reflects the importance of each node by taking into account its topological location, its demand value and the demand distribution of other nodes in the network.

The demand centrality of Node  $v$  is defined based on a weighted count of all shortest paths between a source node and a demand node that contain Node  $v$ . More precisely, the demand centrality is obtained by limiting the number of paths based on the principle that the paths connecting the source node to other nodes in WDNs have far more contribution than those of connecting two sink nodes. Additionally, a positive and extensive hydraulic weight,  $w_{s,v}$ , is assigned to each Node  $v$ . This weighting factor denotes the importance of a demand node in terms of the value of its demand along with the relative distances of the sink nodes to the source node.

Let  $S$  and  $D$  be the set of source and demand nodes, respectively. Given a junction Node  $v$  in a WDN and an ordered pair of nodes  $(s, r)$  where  $s \in S$  and  $r, v \in D$ , the demand centrality of Node  $v$ , denoted by  $C_D(v)$  is defined as follows:

$$C_D(v) = \sum_{s \neq r \neq v} \frac{n_{s,r}(v)}{n_{s,r}} w_{s,v}, \quad (4)$$

where  $n_{s,r}$  is the number of shortest paths between nodes  $s$  and  $r$ , and  $n_{s,r}(v)$  is the number of shortest paths between nodes  $s$  and  $r$  that pass through Node  $v$ .  $w_{s,v}$  is the weighting factor of each shortest path, which is applied to distinguish the importance of different junction nodes, taking into account their relative distances to the source node as well as the value of their demand. In the case of networks fed by one source node,  $w_{s,v}$  is represented as:

$$w_{s,v} = \frac{Q_s^t}{\sum_{i=1}^{n_d} \left( \frac{R_g}{r_i} q_i^t \right) - q_v^t}, \quad (5)$$

where  $Q_s^t$  denotes the total supply water at time step  $t$ , which is equivalent to the total water consumption by the demand nodes.  $q_i^t$  and  $q_v^t$  are, respectively, the demand values at node  $i$  and  $v$  at time  $t$ , and  $r_i$  is the geodesic distance between the source node and node  $i$ .  $R_g$  is the radius of gyration which is defined as the average square geodesic distance of junction nodes from the source node. The radius of gyration indicates how far from the source node, the junction nodes are distributed. For a network with  $n_d$  junction nodes, it is given by the following equation:

$$R_g = \sqrt{\frac{\sum_{i=1}^{n_d} r_i^2}{n_d}}, \quad (6)$$

as can be seen, the demand value of the Node  $v$ ,  $q_v^t$ , is subtracted from the denominator of the fraction. If the numerator,  $Q_s^t$ , is assumed as a constant quantity, then the higher the demand value of this node is, the higher the value of  $w_{s,v}$  will be, and therefore more important are the paths that pass through the Node  $v$ .

As Segarra and Ribeiro (2016) put forth, the centrality measures can be used in either normalized form (Cadini *et al.*, 2009) or non-normalized form (Boldi and Vigna, 2014). In this work, the interest is in the comparison between different demand centrality values of the nodes, thus, Equation (4) is used in its original form, because this comparison is invariant to any normalization.

$C_D(v)$  is a dual function metric, which serves to characterize both topological and hydraulic characteristics of a network. The weighted summation of demands,  $\sum_{i=1}^{n_d} ((R_g/r_i)q_i^t)$ , in the denominator measures the distribution of the junction nodes around the source node, taking into consideration the demand values of these nodes at a given time step.

For more clarification, the time step  $t$ , when the junction nodes with relatively higher values of demand are located closely around the source node, is first considered. This, in turn, leads to a relatively high value of the sum in the denominator of Equation (5) and therefore the resulting weighting factor would be lesser, assigning less weight to paths in the network. Now, a change in the demand distribution at time step  $t + 1$  is assumed such that the downstream nodes have relatively higher values of demand than those positioned around the source node. In this case, the lower value of the sum in the denominator yields the higher value of the weighting factor, assigning more weight to paths in comparison to the previous case.

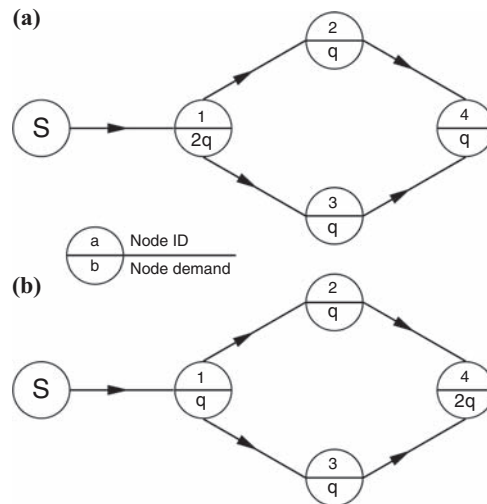
To illustrate the concept underlying the weighting factor,  $w_{s,v}$ , a simple example of the computation of this factor is presented as follows.

Figure 4 depicts a simple network at two different time steps. The network comprises of one source node (Node S) and four sink nodes (Nodes 1, 2, 3, 4). Geodesic distances for the junction nodes are:  $r_1 = 1, r_2 = 2, r_3 = 2, r_4 = 3$ , by using Equation (6), since  $n_d = 4$ , the value of the radius of gyration is:

$$R_g = 2.12.$$

Figure 4(a) represents the time step  $t$ , when a high-demand node (Node 1) is positioned closer to the source node.  $q_2^t = q_3^t = q, Q_s^t = 5q$  and  $\sum_{i=1}^{n_d} ((R_g/r_i)q_i^t) = 7.07q$ , by using Equation (5) and substituting these values:

$$w_{s,v}^t(2) = w_{s,v}^t(3) = 0.824.$$



**Figure 4.** A simple network at two different time steps where the topological configurations are the same but the demand distributions are different

The similar calculation can be performed for the time step  $t + 1$ , Figure 4(b), when a high-demand node (Node 4) is located relatively far from the source node. Thus:

$$w_{s,v}^{t+1}(2) = w_{s,v}^{t+1}(3) = 1.075.$$

This example demonstrates that for a given node,  $w_{s,v}$  can vary due to the differences in the demand distribution of nodes across the network. That is, in the case when the nodes with higher values of demand are farther away from the source node, the weighting factor takes on a higher value in comparison to the case when the high-demand nodes are positioned closer to the source node. Intuitively, this effect can be interpreted as the evidence that the failure of a given node in the former case leads to a higher loss of the performance in the network than that of the latter case. For example, in the example network, the failure of Nodes 2 and 3 at time step  $t$ , Figure 4(a), will leave 60 percent of the households without water, whereas at time step  $t + 1$ , Figure 4(b), this percentage will be 80 percent, indicating a more influential role of these nodes in the latter case, thereby assigning a higher weighting factor ( $w_{s,v}^{t+1}(2) = w_{s,v}^{t+1}(3) = 1.075 > w_{s,v}^t(2) = w_{s,v}^t(3) = 0.824$ ).

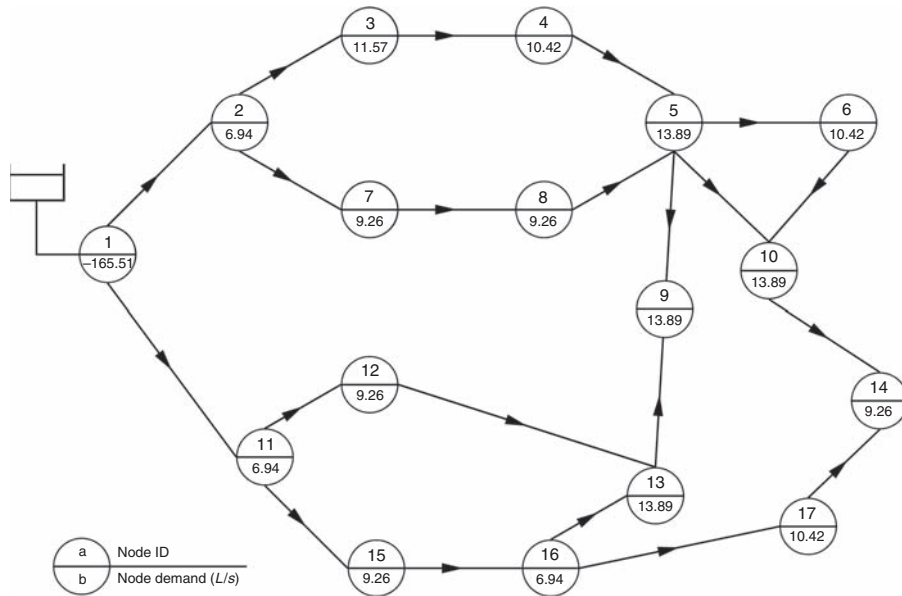
#### 4. A summary of the research design

This research maps a WDN into a graph of nodes and edges. The edges of the graph represent the pipes of a WDN and nodes represent the demand nodes through which water is supplied to the consumers. Each node in the graph is associated with its required flow along with its topological importance. The importance of a node  $i$  in the network is first evaluated by calculating three exemplary centrality measures: closeness, eigenvector, and betweenness centrality. An open source graph analysis software, igraph (Csardi and Nepusz, 2006), is used to compute these centrality values. The radius of gyration is then measured by calculating the average geodesic distances of junction nodes from the source node, using Equation (6). In the next step, Equation (5) is used to quantify the importance of node  $i$  based on the values of the radius of gyration, total required water for the network, and the demand value at node  $i$ . The proposed centrality measure, demand centrality, is obtained by using Equation (4). Finally, demand centrality is compared with closeness, eigenvector and betweenness centrality. The elaborated structure of the proposed method is demonstrated on a real-type case study from literature in the following section.

#### 5. Case study

To illustrate the proposed vulnerability analysis of WDNs, this section analyzes one of the most explored examples of WDN in the literature, taken from Kansal *et al.* (1995) and Shuang *et al.* (2014 and 2015). This example network is a real-type WDN whose characteristics are similar to those of many real networks. This case study provides a realistic topology and the required data regarding the water demand for each junction node in the network. Figure 5 depicts the layout of the example network with one source node, which supplies water to 16 demand nodes connected by 21 pipes. The required water (demand) at different nodes ranges from 6.94 to 13.89  $L/s$  and the total required water supply is 165.51  $L/s$ .

The example network is mapped into a weighted and directed graph with 17 nodes and 21 edges. Water flows are assumed to be uni-directional and directivities are shown by the arrows. The weighting factor  $q_i$  corresponds to the demand in node  $i$  at time step  $t$ . Three classical centrality measures, namely, closeness centrality ( $C_C$ ), eigenvector centrality ( $C_E$ ), and betweenness centrality ( $C_B$ ) are first calculated and the proposed centrality metric, demand centrality ( $C_D$ ), is then computed. After computing the centrality measures, the ranking of each node is obtained, based on its centrality values.



A domain-specific measure of centrality

**Figure 5.** Example network for numerical analysis of the proposed method

## 6. Results and discussion

The numerical results of centrality analysis are presented in Table I. The gray columns report the ranking of the nodes based on the values of their corresponding centrality measures.

In order to provide better visualization of the results, the resulting rankings of the nodes are shown in Table II. Additionally, Figures 6–8 plot the numerical values obtained from Table II.

As expected, the demand centrality ( $C_D$ ) identifies Nodes 2 and 11 as the most important junction nodes in the network. Intuitively, the loss of either of these two nodes can have a severe impact on the overall performance of the network because many shortest paths, originating from the source node, would have to pass through these nodes in order to reach

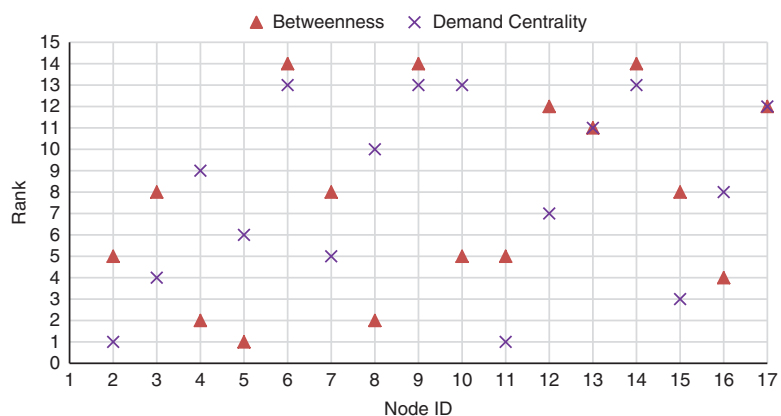
Node ( $i$ )	$C_C(i)$	Rank	$C_E(i)$	Rank	$C_B(i)$	Rank	$C_D(i)$	Rank
2	0.1103	1	0.243	12	0.0292	5	5.61	1
3	0.0860	3	0.255	10	0.0250	8	2.05	4
4	0.0812	5	0.457	5	0.0375	2	1.22	9
5	0.0766	8	1.000	1	0.0917	1	1.66	6
6	0.0664	10	0.625	3	0	14	0	13
7	0.0860	3	0.255	10	0.0250	8	2.03	5
8	0.0812	5	0.457	5	0.0375	2	1.22	10
9	0.0588	15	0.491	4	0	14	0	13
10	0.0625	12	0.716	2	0.0292	5	0	13
11	0.0947	2	0.189	15	0.0292	5	5.61	1
12	0.0664	10	0.195	14	0.0167	12	1.62	7
13	0.0625	12	0.347	7	0.0208	11	0.83	11
14	0.0588	15	0.342	8	0	14	0	13
15	0.0808	7	0.166	16	0.0250	8	2.43	3
16	0.0762	9	0.268	9	0.0333	4	1.60	8
17	0.0625	12	0.222	13	0.0167	12	0.82	12

**Table I.** Numerical values of centrality metrics and nodes ranking

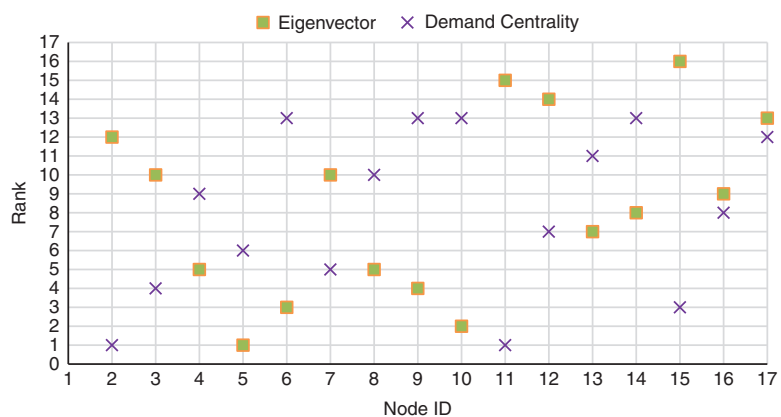
ECAM

Rank	$C_C$	$C_E$	$C_B$	$C_D$
1	2	5	5	2, 11
2	11	10	4, 8	-
3	3, 7	6	-	15
4	-	9	16	3
5	4, 8	4, 8	2, 10, 11	7
6	-	-	-	-
7	15	13	-	12
8	5	14	3, 7, 15	16
9	16	16	-	4
10	6, 12	3, 7	-	8
11	-	-	13	13
12	10, 13, 17	2	12, 17	17
13	-	17	-	6, 9, 10, 14
14	-	12	6, 9, 14	-
15	9, 14	11	-	-
16	-	15	-	-

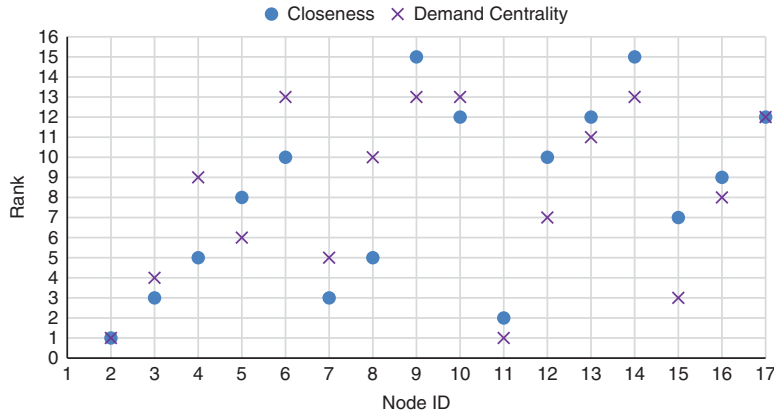
**Table II.**  
Ranking of the nodes using different centrality measures



**Figure 6.**  
Demand centrality ( $C_D$ ) vs Betweenness centrality ( $C_B$ ) for the example network



**Figure 7.**  
Demand centrality ( $C_D$ ) vs Eigenvector centrality ( $C_E$ ) for the example network



A domain-specific measure of centrality

**Figure 8.** Demand centrality ( $C_D$ ) vs Closeness centrality ( $C_C$ ) for the example network

other nodes. By contrast, as reported by Figure 6, the betweenness centrality places Nodes 2 and 11 at the fifth position since this metric is concerned with paths connecting all pairs of nodes rather than just paths originating from the source node.

The betweenness centrality does not discriminate between Nodes 3 and 7, giving the same value of  $C_B(i) = 0.0250$ , while the demand centrality posits Node 7 at a lower position as Node 3,  $C_D(7) = 2.03 < C_D(3) = 2.05$ . This is because the demand centrality takes into account not only the network topology but also the node dynamics with respect to its demand value as well as the demand distribution throughout the network.

Using the eigenvector centrality ( $C_E$ ), Nodes 2 and 11 are, respectively, located at 12 and 15 positions, as shown in Figure 7. This is because the eigenvector centrality is a measure of the extent to which the immediate neighbors of a node are important, therefore it does not necessarily incorporate the location of the node in the network. For instance, in a directed WDN, an upstream node neighboring a few important nodes may be more influential than a downstream node with a larger number of important neighbors. As noted above, the eigenvector centrality fails to capture the influential role of a node due to its location.

The examination of Figure 8 indicates that the using of the closeness centrality ( $C_C$ ) for a directed WDN can be deceiving. For example, when the closeness centrality is applied, a higher rank is attained for Node 8 compared to Node 15 owing to the fact that this metric only measures the mean distance from a node to the other nodes across the network. Intuitively, the loss of the network performance when Node 15 fails, is more pronounced than the failure of Node 8. That is, failure of Node 15 leaves Node 16 without water supply, whereas the alternative paths can convey water to downstream nodes when Node 8 fails. The demand centrality, by contrast, posits Node 15 at the higher position than Node 8, which tends to be more intuitive.

As can be seen from Table II, all classical centrality measures posit Nodes 3 and 7 at a similar position, which can be ascribed to the topological symmetry of these nodes. Similarly, Nodes 4 and 8 have been equally ranked by the classical centrality measures as these nodes are also symmetrically placed in the network. In contrast, demand centrality distinguishes between these nodes by means of assigning different weighting factors to each individual node, representing the relative value of nodal demand.

As above discussion attests, a conspicuous difference between the demand centrality metric and the classical centrality measures is that the value of the demand centrality does not only depend on the topological location of nodes but on their current hydraulic attributes, thereby performing better at ranking the importance of the nodes.

---

## 7. Practical implications

The development of a cost effective predictive maintenance strategy, as well as an accurate vulnerability assessment model, has been widely claimed to hold great promise for water utilities. It is in this spirit that the following practical implications emerge from the centrality analysis proposed in this work.

Budget constraints impede the continuous rehabilitation of an asset (Farran and Zayed, 2012). The maintenance strategy driven by the demand centrality analysis enables practitioners to prioritize the components in the network based on the priority ranking attributed to each node. This allows for the least cost decisions to be made for implementing proper maintenance strategies. Moreover, vulnerability assessment of critical infrastructure is a driving force for a majority of core activities associated with the protection of critical infrastructures (Zio, 2016). In light of this, the output of the centrality analysis proposed herein assists water utilities in identifying the effects of components failure on the network performance, which in turn can support the design and deployment of an effective risk management strategy.

## 8. Conclusion and future directions

The conversion of the conventional centrality analysis methods into a realistic evaluation of vulnerabilities in WDNs can be assisted by the development of a domain-specific centrality measure that is not constrained to capturing very generic topological properties of these networks. The new centrality measure proposed in this work possesses several desirable features. First, unlike the classical centrality metrics, it avoids identifying vulnerabilities by using only the topological attributes of WDNs. Second, it delivers on the promise to explicitly link the topology of the network to the dynamics of demand taking place on the structure. Finally, it significantly reduces the computational efforts by restricting the counted paths in the classical betweenness centrality to the paths connecting the source node and the sink nodes. A comparative evaluation of the three classical centrality metrics with the new centrality measure has been carried out. The main conclusion is that demand centrality seems to have the properties of an accurate measure of the importance of components in WDNs.

The current study is not exempt from limitations. First, the proposed centrality analysis has been developed for WDNs fed by one source node. Future research can build upon the current approach by incorporating multiple source nodes into the analysis. Second, demand centrality has been investigated here for a directed network. It would be helpful if further research could engage in developing an extension of the demand centrality for undirected networks. Third, demand centrality partially describes the hydraulic attributes of a WDN. Forthcoming work might usefully seek to propose a method that accounts for more physical and hydraulic attributes of WDNs such as node elevations, demand multiplier, length of pipes and the pressure head at nodes. Finally, the current method addresses the vulnerability problem at the local level. It is also suggested to extend this research further by linking the local importance of components, measured by demand centrality, to the global vulnerability analysis.

## References

- Agathokleous, A., Christodoulou, C. and Christodoulou, S.E. (2017), "Topological robustness and vulnerability assessment of water distribution networks", *Water Resource Management*, Vol. 31 No. 12, pp. 4007-4021.
- Bavelas, A. (1950), "Communication patterns in task-oriented groups", *The Journal of Acoustical Society of America*, Vol. 22 No. 6, pp. 725-730.
- Bell, J.R. (2014), "Subgroup centrality measures", *Network Science*, Vol. 2 No. 2, pp. 277-297.

- 
- Boldi, P. and Vigna, S. (2014), "Axioms for centrality", *Internet Mathematics*, Vol. 10 No. 2014, pp. 222-262.
- Brandes, U. (2008), "On variants of shortest-path betweenness centrality and their generic computation", *Social Networks*, Vol. 30 No. 2, pp. 136-145.
- Brysbart, G., Mauri, T., de Ruyck, J. and Lensink, M.F. (2019), "Identification of key residues in protein through centrality analysis and flexibility prediction with RINspector", *Current Protocols in Bioinformatics*, Vol. 65 No. 1, pp. 1-19.
- Cadini, F., Zio, E. and Petrescu, A. (2009), "Using centrality measures to rank the importance of the components of a complex network infrastructure", *Lecture Notes in Computer Science*, Vol. 5508, pp. 155-167.
- Candeleri, A., Soldi, D. and Archetti, F. (2015), "Network analysis for resilience evaluation in water distribution networks", *Environmental Engineering & Management Journal (EEMJ)*, Vol. 14 No. 6, pp. 1261-1270.
- Candeloro, L., Savini, L. and Conte, A. (2016), "A new weighted degree centrality measure: the application in animal disease epidemic", *PLoS One*, Vol. 11 No. 11, pp. 1-14.
- Csardi, G. and Nepusz, T. (2006), "The igraph software package for complex network research", *International Journal of Complex Systems*, Vol. 1695 No. 5, pp. 1-9.
- Dehmer, M., Emmert-Streib, F. and Shi, Y. (2017), "Quantitative graph theory: a new branch of graph theory and network science", *Information Sciences*, Vols 418-419 No. 2017, pp. 575-580.
- Di Nardo, A., Giudicianni, C., Greco, R., Herrera, M. and Santonastaso, G.F. (2018), "Applications of graph spectral techniques to water distribution network management", *Water*, Vol. 10 No. 1, pp. 1-16.
- Di Nardo, A., Di Natale, M., Giudicianni, C., Musmarra, D., Rodriguez Varela, J.M., Santonastaso, G.F., Simone, A. and Tzatchkov, V. (2017), "Redundancy features of water distribution systems", *Procedia Engineering*, Vol. 186 No. 2017, pp. 412-419.
- Etezadzadeh, C. (2016), *Smart City? Future City? – Smart City 2.0 as a Livable City and Future Market*, Springer, Wiesbaden.
- Farran, M. and Zayed, T. (2012), "New life-cycle costing approach for infrastructure rehabilitation", *Engineering, Construction and Architectural Management*, Vol. 19 No. 1, pp. 40-60.
- Fletcher, J.M. and Wennekers, T. (2017), "From structure to activity: using centrality measures to predict neuronal activity", *International Journal of Neural Systems*, Vol. 27 No. 2017, pp. 1-16.
- Fragiadakis, M. and Christodoulou, S.E. (2014), "Seismic reliability assessment of urban water networks", *Engineering & Structural Dynamics*, Vol. 43 No. 3, pp. 357-374.
- Fragiadakis, M., Xanthos, S., Eliades, D.G., Gagatsis, A. and Christodoulou, S.E. (2016), "Graph-based hydraulic vulnerability assessment of water distribution networks", *Lecture Notes in Computer Science Engineering & Structural Dynamics*, Vol. 8985, pp. 81-87.
- Geffre, J.L., Deckro, R.F. and Knighton, S.A. (2009), "Determining critical members of layered operational terrorist networks", *The Journal of Defense Modelling and Simulation Applications, Methodology, Technology*, Vol. 6 No. 2, pp. 97-109.
- Gertsbakh, I. and Shpungin, Y. (2011), *Network Reliability and Resilience*, Springer, New York, NY.
- Giudicianni, C., Di Nardo, A., Di Natale, M., Greco, R., Santonastaso, G.F. and Scala, A. (2018), "Topological taxonomy of water distribution networks", *Water*, Vol. 10 No. 4, pp. 1-19.
- Grunspan, D.Z., Wiggins, B.L. and Goodreau, S.M. (2014), "Understanding classrooms through social network analysis: a premier for social network analysis in education research", *CBE-Life Science Education*, Vol. 13 No. 2, pp. 167-178.
- Gunawan, I., Schultmann, F. and Zarghami, S.A. (2017), "The four Rs performance indicators of water distribution networks: a review of research literature", *International Journal of Quality & Reliability Management*, Vol. 34 No. 5, pp. 720-732.
- Herrera, M., Abraham, E. and Stoianov, I. (2016), "A graph-theoretic framework for assessing the resilience of sectorised water distribution networks", *Water Resources Management*, Vol. 30 No. 5, pp. 1685-1699.



- 
- Honglu, L., Zhihong, T., Anqiang, H. and Zaili, Y. (2018), "Analysis of vulnerabilities in maritime supply chains", *Reliability Engineering and System Safety*, Vol. 169 No. 2018, pp. 475-484.
- Joyce, K., Laurienti, P.J., Burdette, J.H. and Hayasaka, S. (2010), "A new measure of centrality for brain networks", *PLoS One*, Vol. 5 No. 8, pp. 1-13.
- Kansal, M.L., Kumar, A. and Sharma, P.B. (1995), "Reliability analysis of water distribution systems under uncertainty", *Reliability Engineering and System Safety*, Vol. 50 No. 1, pp. 51-59.
- Klimek, P., Jovanovic, A.S., Eglhoff, R. and Schneider, K. (2016), "Successful fish go with the flow: citation impact prediction with centrality measures for term-document networks", *Scientometrics*, Vol. 107 No. 3, pp. 1265-1282.
- Laucelli, P. and Giustolisi, O. (2015), "Vulnerability assessment of water distribution networks under seismic actions", *Journal of Water Resources Planning and Management*, Vol. 141 No. 6, pp. 1-13.
- Maiolo, M., Pantusa, D., Carini, M., Capano, G., Chiaravollati, F. and Procopio, A. (2018), "A new vulnerability measure for water distribution network", *Water*, Vol. 10 No. 8, pp. 1-19.
- Meng, F., Guangtao, F., Farmani, R., Sweetapple, C. and Butler, D. (2018), "Topological attributes of network resilience: a study in water distribution systems", *Water Research*, Vol. 143 No. 2018, pp. 376-386.
- Michaud, D. and Apostolakis, E. (2006), "Methodology for ranking the elements of water-supply networks", *Journal of Infrastructure Systems*, Vol. 12 No. 4, pp. 230-242.
- Muric, G., Jorswieck, E. and Scheunert, C. (2016), "Using LTI Dynamics to identify influential nodes in a network", *PLoS One*, Vol. 11 No. 12, pp. 1-21.
- Neal, Z. (2011), "Differentiating centrality and power in the world city network", *Urban Studies*, Vol. 48 No. 13, pp. 2733-2748.
- Pagono, A., Puchinotta, I., Giordano, R. and Fratino, U. (2018), "Integrating 'hard' and 'soft' infrastructural resilience assessment for water distribution systems", *Complexity*, Vol. 2018, pp. 1-16.
- Parand, F.A., Rahimi, H. and Gorzin, M. (2016), "Combining fuzzy logic and eigenvector centrality measure in social network analysis", *Physica A: Statistical Mechanics and its Applications*, Vol. 459 No. 2016, pp. 24-31.
- Pinto, J., Varum, H., Bentes, I. and Agarwal, J. (2010), "A theory of vulnerability of water pipe networks", *Water Resources Management*, Vol. 24 No. 15, pp. 4237-4254.
- Piraveenan, M., Prokopenko, M. and Hossain, L. (2013), "Percolation centrality: quantifying graph-theoretic impact of nodes during percolation in networks", *PLoS One*, Vol. 8 No. 1, pp. 1-14.
- Segarra, S. and Ribeiro, A. (2016), "Stability and continuity of centrality measures in weighted graphs", *IEEE Transactions on Signal Processing*, Vol. 64 No. 3, pp. 543-555.
- Shuang, Q., Zhang, M. and Yuan, Y. (2014), "Node vulnerability of water distribution networks under cascading failures", *Reliability Engineering and System Safety*, Vol. 124 No. 2014, pp. 132-141.
- Shuang, Q., Yuan, Y., Zhang, M. and Liu, Y. (2015), "A cascade-based emergency model for water distribution networks", *Mathematical Problems in Engineering*, Vol. 2015, pp. 1-11.
- Shuang, Q., Liy, Y., Tang, Y., Liu, J. and Shuang, K. (2017), "System reliability evaluation in water distribution networks with the impact of valves experiencing cascading failures", *Water*, Vol. 9 No. 6, pp. 1-17.
- Xuan My Tran, P., Malano, H.M. and Thompson, R.G. (2003), "Application of analytical hierarchy process to prioritize irrigation asset renewals: the case of the La Khe irrigation scheme, Vietnam", *Engineering, Construction and Architectural Management*, Vol. 10 No. 6, pp. 382-390.
- Yazdani, A. and Jeffrey, P. (2012), "Water distribution system vulnerability analysis using weighted and directed network models", *Water Resource Research*, Vol. 48 No. 6, pp. 1-10.
- Yazdani, A., Otoo, R.A. and Jeffrey, P. (2011), "Resilience enhancing expansion strategies for water distribution systems: a network theory approach", *Environmental Modelling and Software*, Vol. 26 No. 12, pp. 1574-1582.

- Zarghami, S.A., Gunawan, I. and Schultmann, F. (2018a), "Integrating entropy theory and cospanning tree technique for redundancy analysis of water distribution networks", *Reliability Engineering and System Safety*, Vol. 176 No. 2018, pp. 102-112.
- Zarghami, S.A., Gunawan, I. and Schultmann, F. (2018b), "System dynamics modelling process in water sector: a review of research literature", *System Research and Behavioral Sciences*, Vol. 35 No. 6, pp. 776-790.
- Zarghami, S.A., Gunawan, I. and Schultmann, F. (2019), "Entropy of centrality values for topological vulnerability analysis of water distribution networks", *Built Environment Project and Asset Management*, Vol. 9 No. 3, pp. 412-425, available at: <https://doi.org/10.1108/BEPAM-02-2019-0014>
- Zhao, S., Zhao, P. and Cui, Y. (2017), "A network centrality measure framework for analyzing urban traffic flow: a case study of Wuhan, China", *Physica A: Statistical Mechanics and its Applications*, Vol. 478 No. 2017, pp. 143-157.
- Zio, E. (2016), "Challenges in the vulnerability and risk analysis of critical infrastructures", *Reliability Engineering and System Safety*, Vol. 152 No. 2016, pp. 137-150.
- Zio, E. and Piccinelli, R. (2010), "Randomized flow model and centrality measure for electrical power transmission network analysis", *Reliability Engineering and System Safety*, Vol. 95 No. 4, pp. 379-385.

#### About the authors

Seyed Ashkan Zarghami is currently in the final stage of his PhD study in Faculty of Professions at the University of Adelaide. He is researching on complex system analysis of infrastructure networks. He holds a Bachelor's degree in civil engineering, a Master's degree in project management and a Master's degree in civil and structural engineering. His current research interests include project management, system engineering, reliability analysis of infrastructure networks and operations management. Ashkan has a great passion for proposing novel ideas and his research appeared in top ranked international. Prior to his doctoral study, he worked for several years in large-scale construction and infrastructure network projects. Ashkan has developed his expertise and interest in project management through undertaking a wide range of research and engineering duties to support a variety of complex projects. Seyed Ashkan Zarghami is the corresponding author and can be contacted at: [ashkan.zarghami@adelaide.edu.au](mailto:ashkan.zarghami@adelaide.edu.au)

Indra Gunawan is Associate Professor in Complex Project Management and Director of Project Management Program in the Entrepreneurship, Commercialisation and Innovation Centre at the University of Adelaide, Australia. He received his PhD in Industrial Engineering and MSc in Construction Management from Northeastern University, USA. His current research interests include system reliability modeling, maintenance optimization, project management, applications of operations research and operations management. His work has appeared in many peer-reviewed journals and conference proceedings.

---

For instructions on how to order reprints of this article, please visit our website:

[www.emeraldgroupublishing.com/licensing/reprints.htm](http://www.emeraldgroupublishing.com/licensing/reprints.htm)

Or contact us for further details: [permissions@emeraldinsight.com](mailto:permissions@emeraldinsight.com)

# *Chapter 8*

## Application of System Dynamics Modelling Approach to WDNs

## 8. Application of System Dynamics Modelling Approach to WDNs

### 8.1. Paper 9: System dynamics modelling approach for robustness analysis of water distribution networks

## Statement of Authorship

Title of Paper	System Dynamics Modeling for Robustness Analysis of Water Distribution Networks
Publication Status	<input type="checkbox"/> Published <input type="checkbox"/> Accepted for Publication <input checked="" type="checkbox"/> Submitted for Publication <input type="checkbox"/> Unpublished and Unsubmitted work written in manuscript style
Publication Details	Zarghami S.A., and Gunawan, I. (2019). System Dynamics Modeling for Robustness Analysis of Water Distribution Networks. <i>Reliability Engineering and System Safety</i> . Under Review.

### Principal Author

Name of Principal Author (Candidate)	Seyed Ashkan Zarghami
Contribution to the Paper	Design the model and computational framework- Developing the theory- Proposing a new method- Performing the analytic calculations- Demonstrating the proposed method on case studies-Discussion of results- Identifying avenues for future work- Writing the manuscript
Overall percentage (%)	85%
Certification:	This paper reports on original research I conducted during the period of my Higher Degree by Research candidature and is not subject to any obligations or contractual agreements with a third party that would constrain its inclusion in this thesis. I am the primary author of this paper.
Signature	_____ Date <b>02/05/19</b>

### Co-Author Contributions

By signing the Statement of Authorship, each author certifies that:

- i. the candidate's stated contribution to the publication is accurate (as detailed above);
- ii. permission is granted for the candidate to include the publication in the thesis; and
- iii. the sum of all co-author contributions is equal to 100% less the candidate's stated contribution.

Name of Co-Author	Associate Professor Indra Gunawan
Contribution to the Paper	Supervising development of the work- Verifying the numerical results- Evaluation of the manuscript- Helping to edit the manuscript-Final approval of the version to be published
Signature	_____ Date <b>2/5/19</b>

Name of Co-Author	
Contribution to the Paper	
Signature	_____ Date _____

Please cut and paste additional co-author panels here as required.

## Manuscript Details

<b>Manuscript number</b>	RESS_2019_346
<b>Title</b>	System Dynamics Modeling for Robustness Analysis of Water Distribution Networks
<b>Article type</b>	Research Paper

### Abstract

Robustness analysis of Water Distribution Networks (WDNs) is gaining recognition in the research literature. While the robustness analysis is garnering much attention, there is a knowledge gap surrounding the evolution of the robustness in response to changes in the parameters involving in the analysis. To fill this gap, this paper looks at the robustness of WDNs through the lens of System Dynamics (SD) modeling approach. The objective of this study is to design a dynamic model for robustness analysis of WDNs that can be updated as its constituent variables change over time. The proposed SD modeling approach is developed for a real-world case study of an Australian town. A scenario analysis is performed to investigate the effects of different population growth rates on robustness. The results showed that uneven demand distribution forced by uneven population growth has a strong influence on the robustness of WDNs.

<b>Keywords</b>	Entropy-based robustness index; Stock and flow diagram; Robustness; System Dynamics; Water distribution networks
<b>Corresponding Author</b>	Seyed Ashkan Zarghami
<b>Corresponding Author's Institution</b>	University of Adelaide
<b>Order of Authors</b>	Seyed Ashkan Zarghami, Indra Gunawan
<b>Suggested reviewers</b>	Iwan Vanany, Hennie Husniah, Harpreet Kandra

## Submission Files Included in this PDF

### File Name [File Type]

Paper6-RESS.docx [Manuscript File]

To view all the submission files, including those not included in the PDF, click on the manuscript title on your EVISE Homepage, then click 'Download zip file'.

# **System Dynamics Modeling for Robustness Analysis of Water Distribution Networks**

## ***Abstract***

Robustness analysis of Water Distribution Networks (WDNs) is gaining recognition in the research literature. While the robustness analysis is garnering much attention, there is a knowledge gap surrounding the evolution of the robustness in response to changes in the parameters involving in the analysis. To fill this gap, this paper looks at the robustness of WDNs through the lens of System Dynamics (SD) modeling approach. The objective of this study is to design a dynamic model for robustness analysis of WDNs that can be updated as its constituent variables change over time. The proposed SD modeling approach is developed for a real-world case study of an Australian town. A scenario analysis is performed to investigate the effects of different population growth rates on robustness. The results showed that uneven demand distribution forced by uneven population growth has a strong influence on the robustness of WDNs.

*Keywords:* Entropy-based robustness index; Stock and flow diagram; Robustness; System Dynamics; Water distribution networks.

## **Introduction**

Robustness of a Water Distribution Network (WDN) is concerned with the ability of the network to minimize the effects of disruptive events on the community it serves. The performance of WDNs depends upon complex interactions among a large number of subsystems and components as well as the external conditions (Gunawan *et al.*, 2017). The inherent complexity of WDNs reinforces the need for advanced methods to model the reliability and robustness of these networks (Tang *et al.*, 2019).

Due to this complexity, there is not a universally accepted measure of the robustness. In the recent literature, the robustness has been mainly viewed as the capability of a network to provide the required level of supply of service in the case of partial failures (Ferrario *et al.*, 2016). As a result, a bulk of research has measured the robustness of networks by analyzing the functional or structural changes when a node or fraction of nodes are removed. Reed *et al.* (2009) assessed the fragility of a networked infrastructure by measuring the fraction of the number of disservices and the total number of customers. Iyer *et al.* (2013) evaluated the robustness of a networked system by investigating the effect of simultaneous and sequential removal of its nodes on the structure of the network. Wang *et al.* (2014) adopted a graph-based metric for quantifying the influence of adding or removing links on the robustness of infrastructure networks.

In the context of WDNs, much effort is currently devoted to evaluate the robustness as an indirect measure of reliability. A great many methods to analyze the robustness of WDNs have been developed hitherto. These methods can be broadly categorized into three groups: topological, hydraulic and entropic (Ostfeld, 2004). The topological approach is concerned with the connectivity of a network, given its component reliabilities (e.g., Wagner *et al.*, 1988; Yazdani and Jeffrey, 2012). The hydraulic methods address the supply of the required quantity of water under adequate pressure (e.g., Gupta *et al.*, 2014; Tanyimboh *et al.* 2016). The entropic approach posits the informational entropy as a tool to measure the reliability and robustness of a WDN (e.g., Greco *et al.*, 2012, Zarghami *et al.* 2018a)

While WDNs are fundamentally complex dynamics systems, the references just cited, address the question of system robustness statically. These methods ignore the

variation in the parameters involving in the robustness analysis and are inadequate in dealing with the dynamics of the network. There is a need, therefore, for a complementary approach to evaluate the robustness in response to changes in its variables over time. It is in this spirit that this paper provides a System Dynamics (SD) model for analyzing the robustness. The model is designed as a living entity that can be updated as its constituent variables change over time (Beall *et al.*, 2011). More precisely, this approach is aimed at offering a valid tool to determine the current robustness of WDNs and their vulnerability to future change by turning the conventional robustness analysis into a Stock and Flow Diagram (SFD) that allows simulation and scenario analysis.

The study contributes to the robustness analysis of WDNs by creating the link between the robustness and its constituent variables. In fact, this link answers such questions as “To what extent change in the initial state of the network affects the robustness at some point in time?” “How might different scenarios affect the robustness over time?”.

The paper is structured as follows. In the next section, the building blocks of SD followed by its application in the water sector are presented. The following section introduces the robustness index using for the proposed SD model followed by the development of the proposed SD-based robustness analysis. Conclusions and areas for future research are discussed in the end.

## **System dynamics and its application in the water sector**

A system is a collection of interacting entities that work together to achieve an objective. SD is the study of the dynamics of a system, which is mainly concerned with the behavior of a system that can be observed over an interval of time (Birta and Arbez,



2013). SD is an effective simulation approach, which has a laudable aim of capturing the dynamic interactions within a system from a holistic perspective (Sterman, 2000).

An SD model consists of variables and links between these variables. Variables are labeled as stocks, flows, auxiliaries and constants. Accumulation of materials and information is the basic principle of SD. A stock variable accumulates materials and information over time and represents the state of the system. The action of a flow variable changes the state of a stock. Auxiliary variables are neither stocks nor flows, but the function of the stocks. Variables are related by causal links. The polarity of a link is either negative or positive. In a positive link, the cause and the effect change in the same direction (the cause increases, then the effect increases), whereas in a negative link they change in the opposite direction (the cause increases/decreases the effect decreases/increases). Two or more causal loop constitute a feedback loop in such a way that a causality starting at any element in the loop ripples through a chain of causation and eventually returns to the first element. Generally speaking, feedback loops are either reinforcing (positive) or balancing (negative). In a reinforcing feedback loop an initial increase/decrease in a given variable leads after some time to an additional increase/decrease in that variable, whereas in a balancing feedback loop an initial increase/decrease in a given variable leads after some time to a/an decrease/increase in that variable(Pruyt, 2013).

The variables just described, are constitutive elements of an SFD diagram. An SFD forms the basis for simulation of how a system behaves over an interval of time under varying conditions. It enables the modeler to quantify all entities of a system along with the interactions between them, using data and mathematical equations. Graphically, sources and sinks are the system boundaries, indicated by clouds at the



(e.g. Wirahadikusumah and Abraham, 2003; Guest *et al.*, 2010; Rehan *et al.*, 2011 and 2014).

In all cited studies above, SD has been successfully leveraged in managing the complexity of water resources and sewer systems. Yet no academic research has adopted this technique for quantifying the WDN performance indicators such as reliability, robustness, redundancy, and resilience. The presented paper attempts to fill this gap by looking at the robustness of a WDN and its variables through the lens of SD.

### **A motivating robustness measure**

As stated in the introduction section, there is a set of methods that can be used for robustness analysis of complex systems and in particular WDNs. Of these, for the proposed SD modeling, the entropy-based robustness index developed by Zarghami *et al.* (2018b) is chosen. The selected method adopts the concept of the informational entropy, introduced by Shannon (1948), as a tool for measuring the robustness of WDNs. This entropy-based method is selected due to the following reasons. First, unlike most existing robustness analysis techniques, the method is specifically tied to the WDN field by developing a domain-specific robustness index. Second, the method is practical and computationally efficient. Third, only water demand and topology are required for its computation (Tanyimboh, 2017; Santonastaso *et al.*, 2018).

This entropy-based robustness index (*RI*) can be mathematically expressed by the following equation:

$$RI = \frac{\sum_{i=1}^n \left(\frac{q_i}{Q_t}\right) \log_2 \left(\frac{q_i}{Q_t}\right)}{\log_2 n} \quad (1)$$

where  $n$  is the number of nodes,  $q_i$  denotes the required flow (demand) at node  $i$ , and  $Q_t$  represents the total required flow in the network.

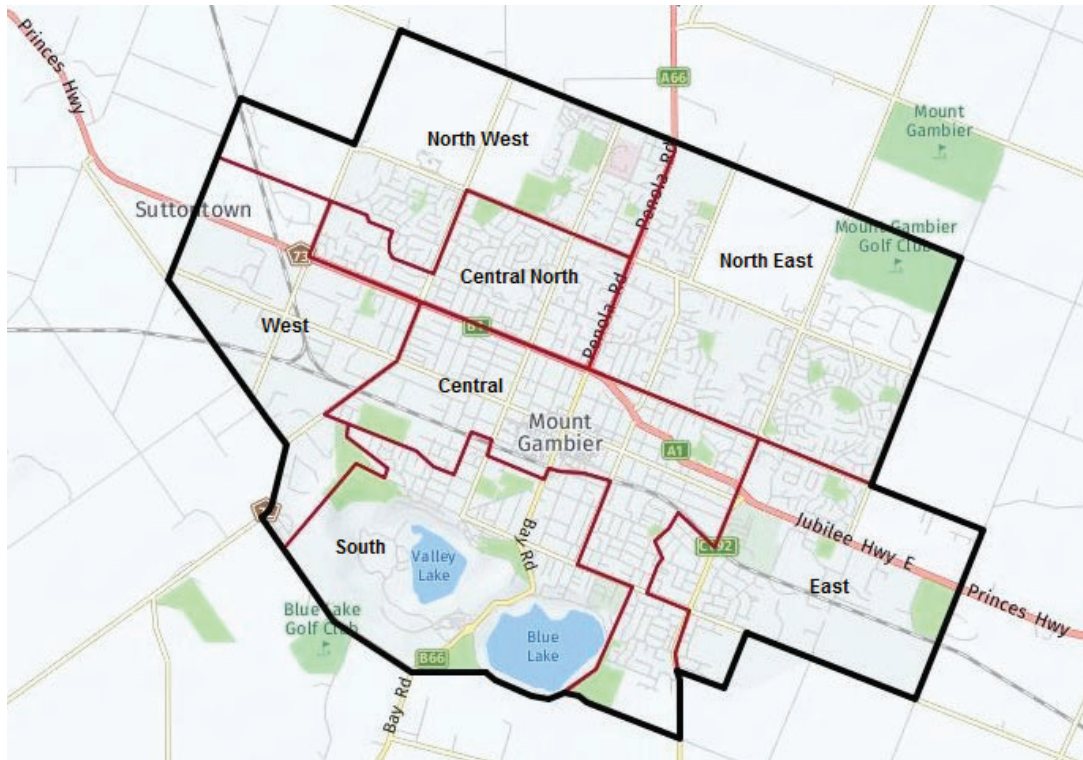
By definition  $0 \leq RI \leq 1$ . A network with a higher value of  $RI$  demonstrates higher robustness than that of with a lower value.  $RI$  attains its maximum value ( $RI = 1$ ) when all demand nodes are of equal value.

$RI$  is based on the principle that removal of a node with a relatively high value of demand leaves a larger number of consumers without water supply in comparison to the failure of a node with a lower value of demand. Thus, theoretically, if all nodes are of equal value of demand, when a random failure or a targeted attack occurs, a lower drop in the performance of the network is expected. Therefore, measuring the heterogeneity of the demand nodes is a proxy for measuring the robustness of the network in this method.

$RI$  provides a snapshot of the network robustness at a given point in time and does not provide any trend for its evolution. In the following section, we will discuss a possible means to circumvent this problem. We utilize an SD simulation model in order to link the changes in demand to the robustness of WDNs. Through this link, we present various values of robustness index over time involving different demand growth rates with simulations of the SD model.

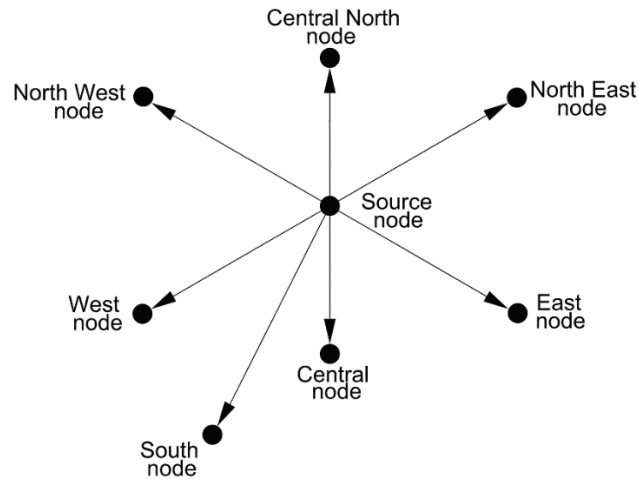
### **SD model development: the case study of Mount Gambier city**

To demonstrate the proposed SD-based robustness analysis and illustrate the calculation process, a real-world WDN of the city of Mount Gambier is used as a case study. Mount Gambier is the second most populated city in South Australia, located 430 km south east of Adelaide, Australia. The layout of the city is obtained from a public data website (<https://profile.id.com.au>).



**Fig. 2.** Example network for numerical analysis of the proposed method

The SD model is divided into seven different suburbs: North West, North East, Central North, West, Central, East, and South. We assume that water is fed to the network through seven demand nodes. Each demand node represents a specified geographic region, which is directly connected to a source node, as shown in Figure 3.



**Fig. 3.** A simplified representation of the demand nodes

### ***Initial Condition and assumptions***

Water demand is a non-stationary process due to the coupled relationship between human and natural systems in urban areas (House-Peters and Chang, 2011; Quiñones-Grueiro *et al.*, 2017). As Griffion and Van Zyl (2014) put forward, a wide range of factors influences the water demand. These factors may vary from socio-economic factors (e.g., population growth, water price, income, household characteristics and demographics) to climatic factors (e.g., temperature, rainfall, humidity) or structural parameters (e.g., water metering, plumbing fitting, pressure and network capacity). Nevertheless, in this paper, as suggested by Schutte and Pretorius (1997), the increase in water demand is just seen to account for the population growth rather than other factors mentioned earlier. Since the population growth, as a sole factor, characterizes the rate of change in water demand, throughout this paper, the terms, *population*, and *demand* are used interchangeably.

Despite the fact that the increased population will result in increased burdens on water resources, we assume that existing water supply can support the increasing demand and, therefore, adequate supplies are available over the simulation period.

The time horizon for the simulation model extends from 2016 to 2050 and the model runs at a yearly time step. The SD model requires an initial population size at a starting time (2016). Table 1 reports the suburban populations of the case study based on the results from the 2016 census delivered in the public website <https://profile.id.com.au>.

**Table 1-** Suburban populations of the city of Mount Gambier (as of June 2016)

Suburb	Population
North West	3179
North East	6236
Central North	4780
West	886
Central	6360
East	2701
South	2721

***Turning the robustness analysis into a stock and flow diagram***

The robustness index, presented in section 3, is now transformed to an SFD. The key variables in the SFD are the population of the suburbs, total population, population growth rates, and fractional populations. The main output of the model is the network robustness. These variables and their corresponding symbols are presented in Table 2.

**Table 2-** Symbols of variables in the SD model

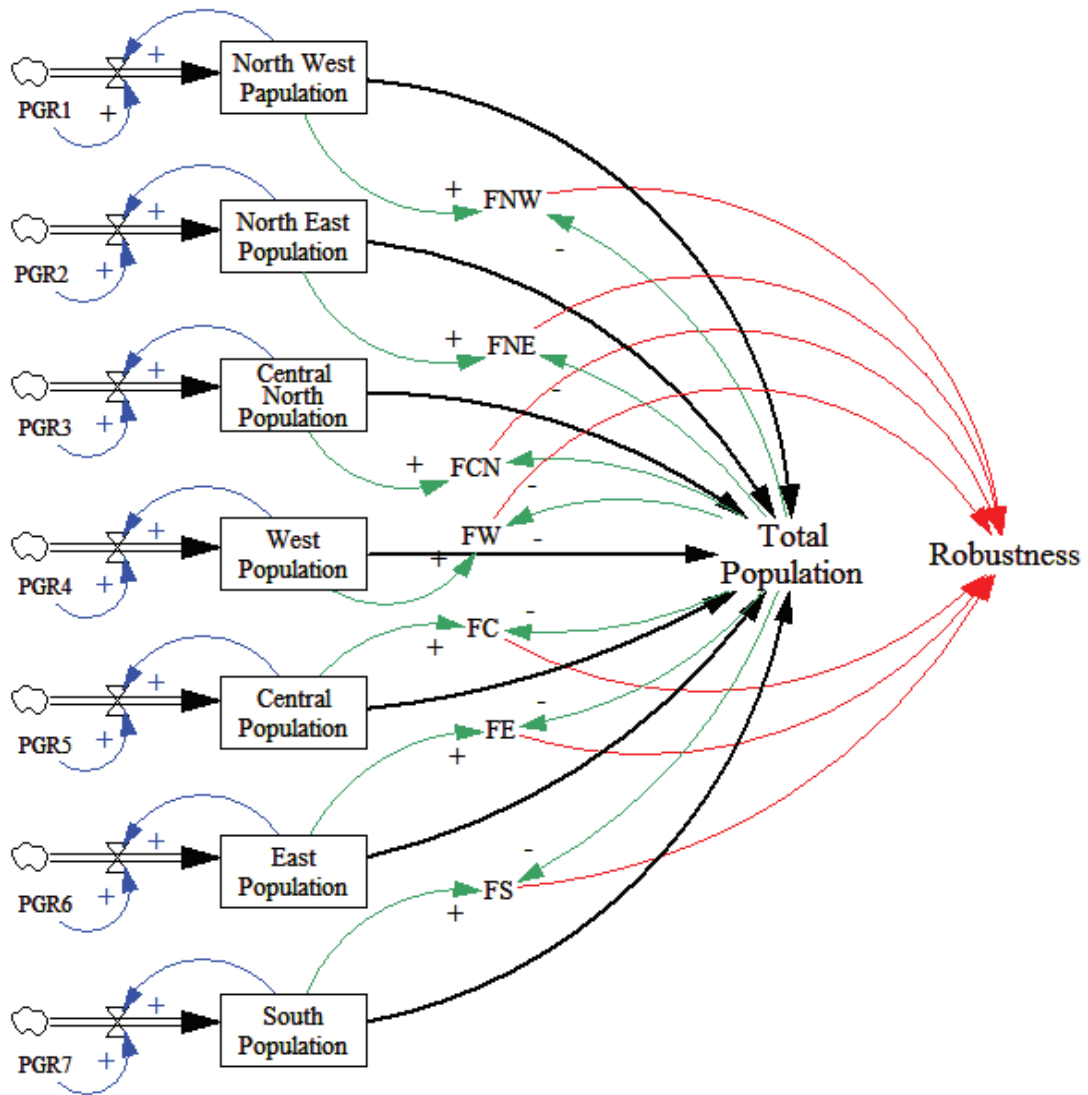
SD model Symbol	Variable	Mathematical representation
PGR1	Population growth rate of the North West suburb	$PGR_1$
PGR2	Population growth rate of the North East suburb	$PGR_2$
PGR3	Population growth rate of the Central North suburb	$PGR_3$
PGR4	Population growth rate of the West suburb	$PGR_4$
PGR5	Population growth rate of the Central suburb	$PGR_5$
PGR6	Population growth rate of the East suburb	$PGR_6$
PGR7	Population growth rate of the South suburb	$PGR_7$
FNW	Fractional population of the North West suburb	$F_1$
FNE	Fractional population of the North East suburb	$F_2$
FCN	Fractional population of the Central North suburb	$F_3$
FW	Fractional population of the West suburb	$F_4$
FC	Fractional population of the Central suburb	$F_5$
FE	Fractional population of the East suburb	$F_6$
FS	Fractional population of the South suburb	$F_7$
-	North West population	$P_1$
-	North East population	$P_2$
-	Central North population	$P_3$
-	West population	$P_4$
-	Central population	$P_5$
-	East population	$P_6$
-	South population	$P_7$
-	Total population	$P_T$



-	Entropy	$H_F$
-	Robustness	$RI$

---

The SFD is constructed with the aid of *Vensim PLE 7.1* (Ventana Systems, 2007), which provides a platform for a quantitative analysis of an SD model with the ability for detailed analysis of the results. As shown in Figure 4, the SFD depicts the main cause and effect relationships between the constituent variables of the robustness index described in the preceding section. The model has seven stock variables, representing the seven suburbs in the city of Mount Gambier. The overall concept of the SFD can be worded as follows.



**Fig.4.** SD model of the case study

As discussed earlier, population growth is considered as a sole driving force for the increase in the value of water demand. Based on different population growth rates, the model generates water demands for different areas across the city over time. Each suburb is represented as a stock. The inflow to each stock is the population growth. The population of each suburb controls the population growth by a positive feedback loop, resulting in an exponential growth behavior. The population of each suburb at time  $t + dt$  is calculated using the following equation.

$$P_i(t + dt) = P_i(t) + PGR_i dt \quad (2)$$

where  $P_i(t + dt)$  denotes the population of suburb  $i$  at time  $t + dt$ ,  $P_i(t)$  is the population of suburb  $i$  at time  $t$ , and  $PGR_i$  represents the population growth rate for suburb  $i$ .

The total population of the city ( $P_t$ ), which is the sum of population of the seven suburbs, is represented as an auxiliary variable. As shown in Figure 4, the population of a suburb ( $P_i$ ) along with the total population of the city ( $P_T$ ) governs the fractional population ( $F_i = \frac{P_i}{P_T}$ ). With the accumulation of a suburban population, the total population increases. However, the resulting fraction might be higher or smaller than the starting fraction because either of  $P_i$  or  $P_T$  may increase faster than the other one.

The entropy of the fractional populations is determinant of the robustness. The robustness index ( $RI$ ) at a given point in time is obtained by restating Eq. (1) as given below:

$$RI = \frac{\sum_{i=1}^7 (F_i) \cdot \log_2 (F_i)}{\log_2 7} \quad (3)$$

where the numerator is the entropy of  $\{F_i | i = 1, 2, \dots, 7\}$  and the denominator is the maximum possible value of the entropy.

A change in  $F_i$  induces a change in the robustness of the network. The impact of each fractional population on the robustness is driven by a causal link with unknown polarity because the robustness does not depend upon the actual value taken by the random variables, it depends only upon their relative probabilities (Datta and Munshi, 2017).

### ***Discussion on SD simulation and scenario analysis***

The population growth pattern may vary between different areas for a host of reasons, including city council policies, education systems, and tourist attractions. One way to investigate the impact of this variation on the robustness of the network is to apply a set of assumptions by assigning different growth rates to each suburb. In doing so, the first hypothetical scenario can be assigning all suburbs the same rate (0.9%). Alternatively, the population growth can be modeled under the assumption that the high growth rates spread across the high-populated areas (e.g. Central, North East and Central North suburbs). Finally, the third hypothetical scenario can be that the population growth rate for the low-populated areas (e.g. West, South and East suburbs) would be much higher than the high-populated suburbs. These scenarios are listed in Table 3.

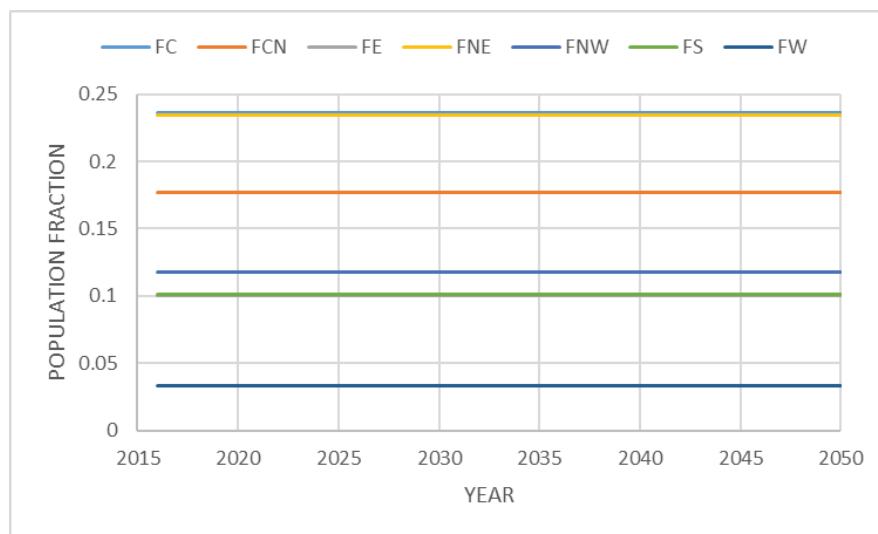
**Table 3-** Population growth rate (%) in different scenarios

Area	Population	Scenario 1	Scenario 2	Scenario 3
North West	3179	0.90	0.60	0.60
North East	6236	0.90	8	0.12
Central North	4780	0.90	3	0.15
West	886	0.90	0.10	8
Central	6360	0.90	9	0.10
East	2701	0.90	0.12	3
South	2721	0.90	0.15	9

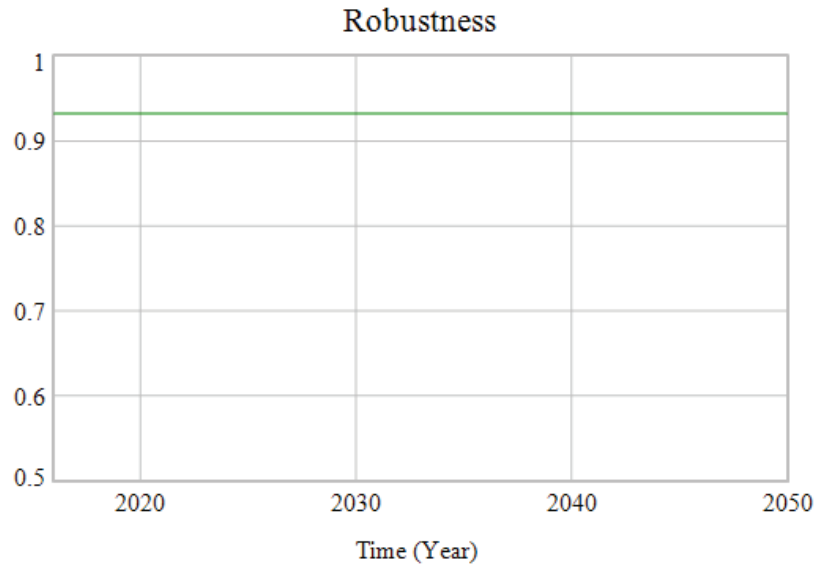
The scenario analysis is now performed to better understand the effects of different population growth rates on the robustness of the network. The model is simulated into the future based on the three scenarios reported in Table 3. The model starts in 2016

and is simulated on a yearly basis. Figure 4, Figure 6 and Figure 8 allow a contrast between the population fractions of different suburbs over time for the scenario 1,2 and 3, respectively. The robustness index of each scenario is graphed in Figure 5, Figure 7 and Figure 9.

As noted earlier, the first scenario is selected based on a constant population growth rate of 0.90% for all suburbs. Examination of Figure 4 and Figure 5 reveals that the population fractions in this scenario for all suburbs remain as their 2016 values throughout the simulation period. This turns out to leave the robustness index unchanged as its 2016 value (0.9323). This is because the distribution of these fractions remains intact over the simulation period, so do the entropy and robustness.

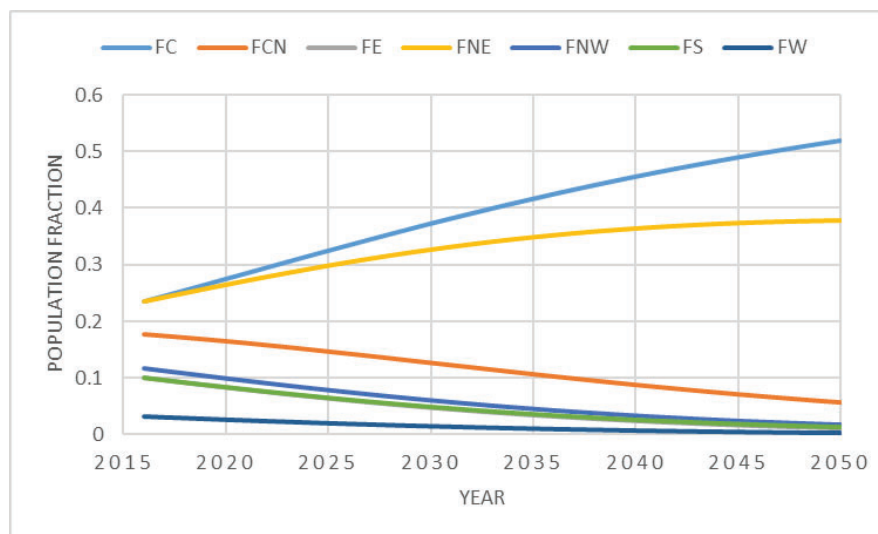


**Fig. 4.** Changes in the population fraction over time- Scenario 1



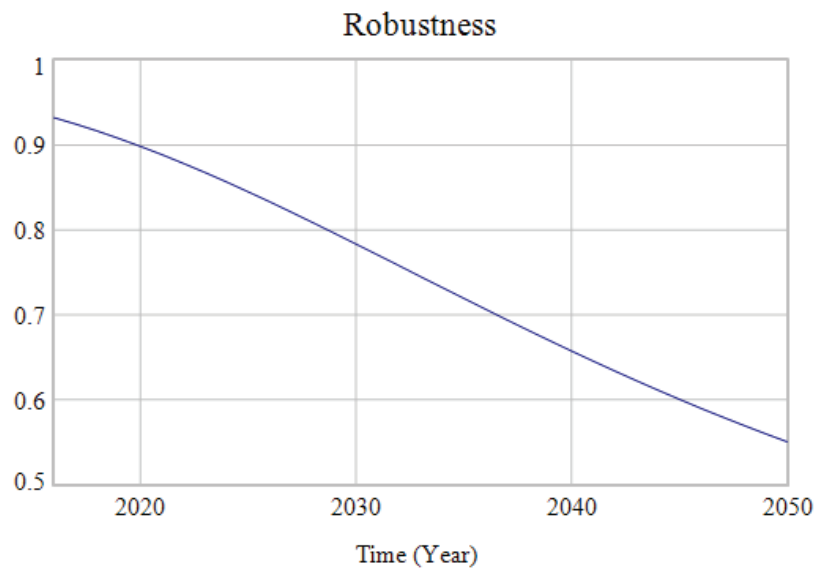
**Fig. 5.** The robustness index over time- Scenario 1

As can be seen in the second scenario (Figure 6), the suburbs which are densely populated (e.g. Central, North East) experience higher growth rates relative to the suburbs which are sparsely populated (e.g. South, West, East). As a result, the population fraction values diverge over time due to a drastic surge in the population of the high-populated suburbs along with a slight increase in the population of the low-populated suburbs.



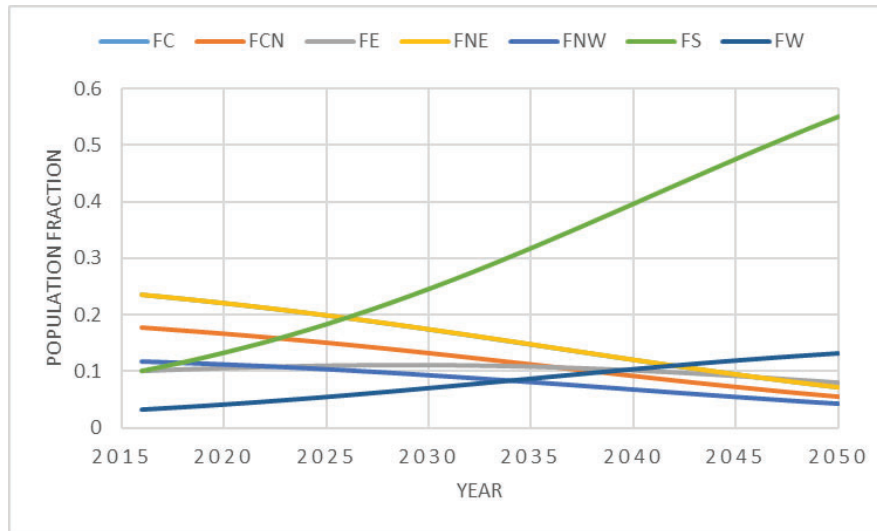
**Fig. 6.** Changes in the population fraction over time- Scenario 2

An obvious concern with respect to the value of *RI* emerges when the increasing divergence in the value of population fractions over the simulation period, causes a sharp and dramatic reduction in the robustness index (Figure 7). This is because *RI* can be understood as a measure of evenness of the population across different suburbs.



**Fig. 7.** The robustness index over time- Scenario 2

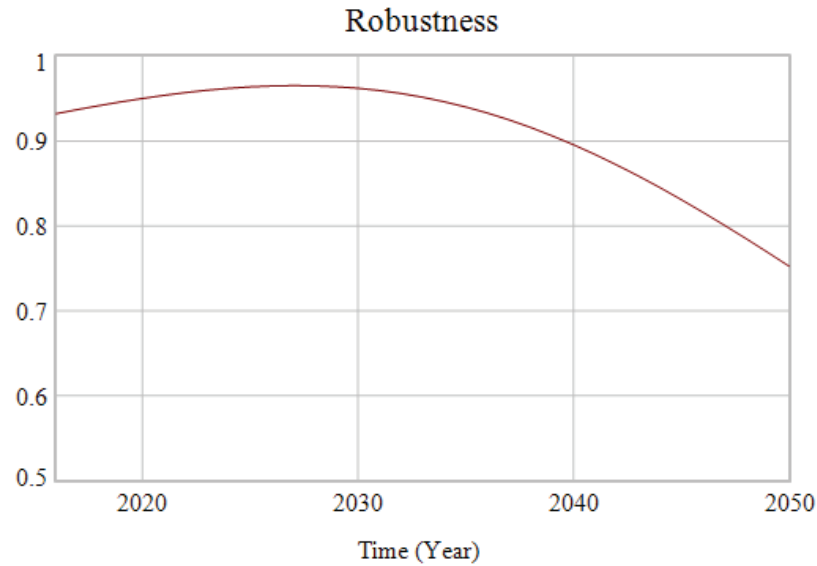
In the scenario 3, as illustrated in Figure 8, the population fraction for South and West districts steadily increase, while for the other suburbs decrease. This can be ascribed to a high value of the population growth rate for South (9%) and West (8%) districts. In spite of a positive population growth rate for other suburbs, the fractional populations tend to decrease since, for these suburbs, the total population increases faster than the suburban population.



**Fig. 8.** Changes in the population fraction over time- Scenario 3

A glance at Figure 9 shows that the robustness increases on 2027 from 0.9323 to 0.9653 but then decreases. The rebound in *RI* is explained by the fact that as the values of the population fractions get closer to  $\frac{1}{7}$  (Figure 8), the more evenness the population distribution is and, therefore, the value of the entropy gets closer to the maximum possible entropy, which in turn results in a relatively high value of the robustness index. After 2027, the large inflow of population to South and West districts increases the heterogeneity in the values of the fractional populations, thereby reducing the robustness of the WDN. Consideration of the discussion presented in the previous scenario makes this an unsurprising result.





**Fig. 9.** The robustness index over time- Scenario 3

What is particularly striking about the contrast between different scenarios is that the robustness of a WDN depends positively on the homogeneity of the fractional population, that is, more homogeneous the distribution of population across the city, the higher the robustness of the network. In essence, a network with a tendency to even population growth exhibits a lower drop in its robustness relative to a network with uneven population distribution.

## **Conclusions**

The complexity of the robustness evaluation of WDNs arises from the temporal behavior of these networks. The robustness analysis of WDNs requires a modeling approach that describes how the variation in the parameters involving in the analysis affects the robustness of the network. The model presented in this paper provides an application of SD as a potent tool to create a link between the robustness and its

constituent variables in order to evaluate the evolution of the robustness in response to changes in its variables over time.

The proposed SD modeling approach differs along two key dimensions. First, this work is the first known application of SD to analyze a quantitative performance indicator of WDNs. Second, in the existing literature, qualitative data is the main source of information in the SD modeling process (Luna-Reyes and Anderson, 2003). As Coyle (2000) put forth, the uncertainty associated with obtaining qualitative data along with quantification of qualitative variables make the SD simulation results fragile. This research uses the information that is purely numerical in nature and therefore uncertainty in obtaining qualitative data and formulating equations do not affect the reliability of the model.

In attempting to study the evolution of the robustness over time, we have proposed three scenarios. The simulation of these scenarios was intended to aid investigating the effects of different population growth rates on the robustness of a real-world case study. Model results showed that uneven demand distribution forced by uneven population growth has a strong influence on the robustness of WDNs. For example, in a network where the densely populated suburbs grow much faster than the sparsely populated areas, the robustness of the WDN tends to decrease.

The following practical implications emerge from the SD model presented in this article. These are of particular relevance for who are concerned with the city development strategies and WDNs. The simulation results indicate how vital it is for urban planners to consider the future development pattern of suburbs at the inception of the city development planning by establishing the urban policies that reduce the formanceuneven growth of the population. The model also can be used as a decision

support tool that helps policy makers to upgrade and update the current urban policies to effectively and efficiently manage the population distribution across the city. Furthermore, water utilities may take advantage of the SD model by conducting what-if analysis and evaluating the network performance under different scenarios, aimed at determining how the performance of a WDN is affected by changes in the assumptions through which the network has been initially designed.

The SD model presented here appears to be useful as a starting point for further studies of the dynamics of the other performance indicators such as reliability, resilience and redundancy of WDNs. Moreover, a large number of topological and hydraulic attributes of WDNs are associated with the robustness of WDNs. Further research might seek to incorporate these factors into the SD-based analysis method proposed in this paper.

## References

1. Ahmad S & Prashar D. 2010. Evaluating Municipal Water Conservation Policies Using a Dynamic Simulation Model. *Water Resources Management* **24**(13): 3371-3395.
2. Beall A, Fiedler F, Boll J, Cosens B. 2011. Sustainable Water Resource Management and Participatory System Dynamics. Case Study: Developing the Palouse Basin Participatory Model', *Sustainability* **3**(2011): 720-742.
3. Birta LG, Arbez G. 2013. *Modelling and Simulation: Exploring Dynamic System Behavior. Second Edition*. Springer-Verlag, London, UK.
4. Coyle G. 2000. Qualitative and quantitative modelling in system dynamics: some research questions. *System Dynamics Review* **16**(3): 225-244.
5. Datta AK, Munshi S. 2017. *Information photonics: Fundamentals, technology, and Applications*. CRC Press, Boca Raton, Florida, USA.

6. Elmahdi A, Malano H& Etchells T. 2007. Using system dynamics to model water-reallocation. *The Environmentalist* **27**(1): 3-12.
7. Ferrario E, Pedroni N, Zio E. 2016. Evaluation of the robustness of critical infrastructures by hierarchical graph representation, clustering and Monte Carlo simulation. *Reliability Engineering and System Safety*. **155**(2016): 78-96.
8. Griffioen M, Van Zyl JE. 2014. Proposed guideline for modelling water demand by suburb. *Journal of South African Institution of Civil Engineering*. **56**(1): 63-68.
9. Greco R, Di Nardo A, Santonastaso G . 2012. Resilience and entropy as indices of robustness of water distribution networks. *Journal of Hydroinformatics*. **14**(3): 761-771.
10. Guest JS, Skerlos SJ, Daigger GT, Corbett JRE & Love NG. 2010. The use of qualitative system dynamics to identify sustainability characteristics of decentralized wastewater management alternatives. *Water Science Technology* **61**(6): 1637-1644.
11. Gunawan I, Schultmann F, Zarghami SA. 2017. The four Rs performance indicators of water distribution networks: A review of research literature. *International Journal of Quality & Reliability Management*. **34**(5): 720-732.
12. Gupta R, Lakshmi BY, Sayyed MA, Rathi S. 2014. Comparison of flow distribution models for design of water distribution networks with redundancy. *Procedia Engineering*. **89**(2014): 848-855.
13. Hassanzadeh E, Elshorbagy A, Wheeler H & Gober P. 2014. Managing water in complex systems: An integrated water resources model for Saskatchewan, Canada. *Environmental Modelling and Software* **58**: 12-26.
14. House-Peters LA, Chang H. 2011. Urban water demand modeling: Review of concepts, methods, and organizing principles. *Water Resources Research*. **47**(5): W05401.
15. Iyer S, Killingback T, Sundaram B, Wang Z. 2013. Attacked robustness and centrality of complex networks. *PLoS ONE*. **8**(4): e59613.
16. Luna-Reyes LF, Andersen DL. 2003. Collecting and analyzing qualitative data for system dynamics: methods and models. *System Dynamics Review* **19**(4): 271-296.

17. Madani K & Mariño MA. 2009. System Dynamics Analysis for Managing Iran's Zayandeh-Rud River Basin. *Water Resources Management* **23**(11): 2163-2187.
18. Mirchi A, Madani K, Watkins D & Ahmad S. 2012. Synthesis of System Dynamics Tools for Holistic Conceptualization of Water Resources Problems. *Water Resources Management* **26**(9): 2421-2442.
19. Ostfeld A. 2004. Reliability analysis of water distribution systems. *Journal of Hydroinformatics*. **6**(4): 281-294.
20. Pruyt E. 2013. *Small System Dynamics Models for Big Issues: Triple Jump towards Real-World Dynamic Complexity*. TU Delft Library, Delft, Netherlands.
21. Quiñones-Grueiro M, Verde C, Llanes-Santiago O. 2017. Demand model in water distribution networks for fault detection. *IFAC-Papers Online*. **50**(1): 3263-3268.
22. Reed DA, Kapur DC, Christie RD. 2009. Methodology for assessing the resilience of networked infrastructure. *IEEE System Journal*. **3**(2): 174-180.
23. Rehan R, Knight MA, Haas CT & Unger AJA. 2011. Application of system dynamics for developing financially self-sustaining management policies for water and wastewater systems. *Water Research* **45**(16):4737-4750.
24. Rehan R, Knight MA, Unger AJA & Haas CT. 2014. Financially sustainable management strategies for urban wastewater collection infrastructure – development of system dynamics model. *Tunneling and Underground Space Technology incorporating Trenchless Technology Research* **39**: 116-129.
25. Sušnic J, Vamvakeridou-Lyroudia LS, Savic DA, Kapelan Z. 2012. Integrated system dynamics modelling for water scarcity assessment: Case study of the Kairouan region. *Science of the Total Environment*. **440**(12): 290-306.
26. Santonastaso GF, Di Nardo A, Di Natale M, Giudicianni C, Greco C. 2018. Scaling-laws of flow entropy with topological metrics of water distribution networks. *Entropy*. **20**(2),95:1-15.
27. Schutte CF, Pretorius WA. 1997. Water demand and population growth. *Water SA*. **23**(1997): 127-134.

28. Shannon CE. 1948. A mathematical theory of communication. *Bell System Technical Journal*. **27**(3): 379-423.
29. Sterman JD. 2000. *Business Dynamics: System Thinking and Modeling for a Complex World*. McGraw-Hill/ Irwin, New York, USA.
30. Tang K, Parsons DJ, Jude S. 2019. Comparison of automatic and guided learning for Bayesian networks to analyse pipe failures in the water distribution systems. *Reliability Engineering and System Safety*. **186**(2019): 24-36.
31. Tanyimboh TT. 2017. Informational entropy: A failure tolerance and reliability surrogate for water distribution networks. *Water Resources Management*. **31**(10): 3189-3204.
32. Tanyimboh TT, Siew C, Saleh S, Czajkowska A. 2016. Comparison of surrogate measures for the reliability and redundancy of water distribution systems. *Water Resources Management*. **30**(10): 3535-3552.
33. Ventana Systems. 2007. *Vensim 5.0. User's Guide*. Ventana Systems Inc, Harvard, MA, USA.
34. Wagner JM, Shamir U, Marks DH. 1988. Water distribution reliability: Analytical methods. *Journal of Water Resources Planning and Management*. **114**(3): 253-275.
35. Walters J & Javernick-Will A. 2015. Long-term functionality of rural water services in developing countries: a system dynamics approach to understanding the dynamic interaction factors. *Environmental Science and Technology* **49**(8): 5035-5043.
36. Wang XJ, Zhang JY, Liu JF, Wang GQ, He RM, Elmahdi A & Elsayah S. 2010. Water resources planning and management based on system dynamics- a case study of Yulin city. *Environment, Development and Sustainability* **13**(2): 331-351.
37. Wang X, Pournaras E, Kooij RE, Van Mieghem P. 2014. Improving robustness of complex networks via the effective graph resistance. *The European Physical Journal B*. **87**(9): 1-12.
38. Wirahadikusumah R & Abraham DM. 2003. Application of dynamic programming and simulation for sewer management. *Engineering, Construction and Architectural Management* **10**(3): 193-208.

39. Yazdani A, Jeffrey P. 2012. Applying network theory to quantify the redundancy and structural robustness of water distribution systems. *Journal of Water Resources Planning and Management*. **138**(2): 153-161.
40. Zarghami SA, Gunawan I, Schultmann F. 2018a. Integrating entropy theory and cospanning tree technique for redundancy analysis of water distribution networks. *Reliability Engineering and System Safety*. **176**(2018): 102-112.
41. Zarghami SA, Gunawan I, Schultmann F. 2018b. Measuring robustness of water distribution networks using informational entropy. In *Proceedings of the 8<sup>th</sup> International Conference on Industrial Engineering and Operations Management*: 3331-3339.
42. .id the population experts, *City of Mount Gambier Community Profile*, viewed 25th February 2018, <https://profile.id.com.au/mount-gambier>.

## *Chapter 9*

### Conclusion



## **9. Conclusion**

WDNs have reached a level of complexity where conventional reliability analysis methods cannot fulfil the challenges for the management of this increased complexity. In fact, the conventional methods are confined to analysing the reliability problems either hydraulically or topologically. While the existing hydraulic-based methods attempt to solve the reliability problems by measuring various hydraulic attributes such as flow, water demand, nodal pressure, and water quality, quantifying the structural organisation of WDNs is missing in these methods. Conversely, the methods presently used for the topological reliability analysis of WDNs have seldom progressed beyond capturing very generic topological characteristics, irrespective of considering the hydraulic behaviour of WDNs. Furthermore, the conventional reliability analysis methods provide a snapshot of the network reliability at a given point in time and do not provide a platform to simulate the changes in the network reliability over time. The present thesis has attempted to fill these gaps. First, it has looked to graph theory for help in understanding the structure and reliability of WDNs. It has then offered two integrated frameworks through which both the structural and hydraulic attributes of WDNs are studied. Finally, this thesis has employed a system dynamics modelling approach in order to develop a model that can be used to make an effective forecast for the reliability of WDNs at a future time.

### **9.1. Research Outcomes**

The development of a comprehensive reliability analysis model is the main outcome of this research. Table 1 shows each outcome separately

Table 1- Research outcomes of this thesis

Paper	Tier-Task	Research Question	Research Outcome
Paper 1	---	Question 1	A source of information as to the current state of the reliability analysis WDNs
Paper 2	---	Question 1	A source of information pertaining to the development of system dynamics modelling approach in the water sector
Paper 3	T1T1	Question 2	An improved reliability block diagram for the exact reliability evaluation of infrastructure networks
Paper 4	T1T1	Question 3	A new topological redundancy index as a proxy to quantify the topological reliability of WDNs
Paper 5	T1T2	Question 4	Creating a link between the global vulnerability of a WDN and the local importance of its components
Paper 6	T2T1	Question 5	Introducing a fuzzy model that maps reliability and centrality to vulnerability
Paper 7	T2T2	Question 6	An entropy-based robustness index that combines the hydraulic and topological attributes of WDNs
Paper 8	T2T2	Question 6	Generating a domain specific centrality measure for WDNs by joint consideration of topological and hydraulic attributes of WDNs
Paper 9	T3T1	Question 7	Designing a dynamic model for robustness analysis of WDNs

## 9.2. Research Findings

A number of case studies have illustrated the effectiveness of various reliability analysis methods proposed in this research. The case studies are based on illustrative examples, WDNs taken from literature, and real-world WDNs of Australian towns. Using these case studies, as shown in Table 2, the following findings have emerged from this thesis.

Table 2- Research findings of this thesis

Paper	Tier-Task	Case Studies	Research Findings
Paper 1	---	---	-There is not a universally accepted definition of reliability for WDNs. -Various performance indicators of WDNs can be used as indirect measures of reliability.
Paper 2	---	---	-Researchers and water utilities can use the outputs of a system dynamics model as a decision support tool. -There is a paucity of research on the application of system dynamics modelling approach in WDNs.
Paper 3	T1T1	An illustrative example	-Coupling spanning tree technique and reliability block diagram into a single framework brings the advantages of simplicity and clarity for evaluating the exact reliability of infrastructure networks. -The proposed method decreases the computational efforts for evaluating the exact reliability by removing the irrelevant edges from the process of reliability calculation.
Paper 4	T1T1	An illustrative example + Yorktown WDN	-Unlike the conventional metrics, the proposed redundancy index does not depend on the density of triangles nor the number of nodes and edges, but on the configuration of pipes and their contribution to overall redundancy of the network. -The new redundancy index performs better at measuring local and global redundancy of a WDN. -The proposed index is consistent with the intuitive notion of the topological redundancy.
Paper 5	T1T2	A case study from literature + Price town WDN	-A network with uniformly distributed centrality values exhibits a lower drop in performance in the case of partial failure of its components and therefore is less vulnerable. -The proposed vulnerability index is capable of capturing the distinctions between various layouts of WDNs.
Paper 6	T2T1	A case study from literature	-Combining the probabilistic and the network-theory based approaches generates a more accurate result for criticality ranking of components of a network. -Vulnerability of a network decreases by increasing reliability and decreasing centrality.
Paper 7	T2T2	Bordertown WDN	-The degree distribution metric spans over a small range of values, as such, it is not informative enough for reliability analysis of WDNs. -Incorporating water demand into the topological robustness analysis of WDNs entails a more reliable estimation.
Paper 8	T2T2	A case study from literature	-The proposed centrality metric yields information that cannot be captured by the classical centrality measures. -The new centrality metric is highly correlated with the hydraulic attributes of WDNs and, therefore, is more accurate at quantifying the importance of components in WDNs.
Paper 9	T3T1	Mount Gambier WDN	-Uneven demand distribution forced by uneven population growth has a strong influence on the robustness (reliability) of WDNs.

### 9.3. Research Contributions

This thesis contributes to water engineering science through theory building and developing a comprehensive reliability analysis model to inform better decision making. The following contributions can be drawn from different tiers and tasks in this thesis.

#### 9.3.1. Tier 1 Task 1 (T1T1): Probabilistic-based reliability analysis

T1T1 seeks to contribute to the reliability analysis of WDNs by paying attention to different performance indicators such as redundancy, resilience, and robustness instead of the incorporation of implicit reliability constraints into reliability analysis. By situating our research in the graph theory context, this tier performs a comprehensive topological reliability analysis by joint consideration of multiple topological characteristics of WDNs. Moreover, this tier attempts to explore the potential of informational entropy as a measure of the network uncertainties and choices to evaluate the overall reliability of WDNs.

#### 9.3.2. Tier 1 Task 2 (T1T2): Importance-based reliability analysis

The key contribution that T1T2 makes is to develop domain specific centrality metrics that evaluate the importance of WDNs elements with respect to their topological location along with their functional attributes. This gives a vivid account of identifying and prioritising (ranking) vulnerabilities in a network.

#### 9.3.3. Tier 2 Task 1 (T2T1): Coupling probabilistic and importance-based methods

As part of the first contribution, T2T1 proposes a novel fuzzy-based vulnerability assessment model in building a qualitative and quantitative picture of the vulnerability of WDNs. The second contribution is especially valuable for vulnerability analysis by virtue of offering a key

to understanding the component vulnerability principle as being constituted by the component likely behaviour as well as the component importance in the network.

#### *9.3.4. Tier 2 Task 2 (T2T2): Integrating topological and hydraulic attributes*

The main contribution of T2T2 is to shift away from an exclusive characterization of WDNs vulnerability and therefore to avoid using only single measurements (either topological or hydraulic measures) as ultimate indicators of vulnerability. Instead, T2T2 will obtain a more accurate vulnerability assessment model of WDNs by concurrent consideration of different attributes of WDNs.

#### *9.3.5. Tier 3 Task 1 (T3T1): System dynamics modelling for robustness analysis of WDNs*

T3T1 contributes to the reliability analysis of WDNs by creating a link between robustness and feedback loops that affect the robustness of a WDN. In fact, this link enables the modeller to evaluate the extent of change in the robustness of a WDN due to future changes in the initial state of the network. Additionally, by performing scenario analysis the modeller will be able to investigate how different scenarios might affect the vulnerability over time.

### **9.4. Limitations of this Research and the Future of Reliability Analysis of WDNs**

Based on the emerging trends in reliability analysis of WDNs, a handful of directions for the future evolution is forecast.

First, there has been major progress in the development of methods for ranking the importance of components in infrastructure networks during the past two decades. Among these methods, centrality analysis is currently pervasive. Accordingly, a great many measures of centrality have been developed hitherto. As pointed out by Boldi and Vigna (2014), the implicit starting

point of all these measures is analysing a structural attribute of networks such as farness, left dominant eigenvector of the adjacency matrix and the number of paths passing through a component. Chapter 7 has attempted to complement the pure topological viewpoint by incorporating water demand as an important hydraulic attribute of WDNs into centrality analysis. Incorporation of more physical and hydraulic attributes of WDNs such as node elevation, nodal pressure, and length and diameter of water pipes are foreseen.

Second, the reliability concept is mainly concerned with the quality in the time dimension (O'Connor, 2000). Nevertheless, reliabilities in the existing methods are treated as static variables. Yet no reliability analysis method seems sophisticated enough to account for the evolution of reliability over time. Chapter 8 has simulated the robustness of a WDN into the future based on different scenarios. However, the proposed model only relies on water demand and the layout of sink nodes, hence partially characterises the network dynamics. Future methods might seek to develop a time-dependant reliability model that incorporates a larger number of topological and hydraulic attributes.

Third, reliability analysis methods have mainly revolved around how well a WDN can satisfy a set of hydraulic or topological objectives. More specifically, the available reliability analysis tools are rooted in reductionism by attempting to simplify the complexity inherent in a WDN rather than facing up to it. These methods neglect emergent behaviours in a network caused by the dynamic interaction among multiple interacting topological and hydraulic attributes of the network. It seems clear that the transition from reductionism to holism will be necessary. The application of system dynamics modelling approach as a viable option to tackle the complexity inherent in WDNs is anticipated.

## References

1. Agathokleous, A., Christodoulou, C., and Christodoulou, S.E. 2017. Topological robustness and vulnerability assessment of water distribution networks. *Water Resource Management*. **31**(12): 4007-4021.
2. Agrawal, M.L., Gupta, R., and Bhave, P.R. 2007. Optimal design of level-1 redundant water distributions considering nodal storage. *Journal of Environmental Engineering*. **133**(3): 319-330.
3. Agudelo-Vera, C., Blokker, M., Vreeburg, J., Bongard, T., Hillegers, S., and Van Der Hoak, J.P. 2014. Robustness of drinking water distribution networks under changing failure demand. *Procedia Engineering*. **89**(2014): 339-346.
4. Aldrich, E.H. 1938. Solutions of transmission problems of a water system. In *Proceedings of American Society of Civil Engineers*. **63**(8): 1511-1534.
5. Atkinson, S., Farmani, R., Fayaz, A.M., and Butler, D. 2014. Reliability indicators for water distribution system design: Comparison. *Journal of Water Resources Planning and Management*. **140**(2): 160-168.
6. Bao, Y., and Mays, L.W. 1990. Model for water distribution system reliability. *Journal of Hydraulic Engineering*. **116**(9): 1119-1137.
7. Beall, A., Fiedler, F., Boll, J., and Cosens, B. 2011. Sustainable Water Resource Management and Participatory System Dynamics. Case Study: Developing the Palouse Basin Participatory Model, *Sustainability* **3**(2011): 720-742.
8. Bloomfield, R.E., Popov, P., Salako, k., Stankovic, V., and Wright, D. 2017. Preliminary interdependency analysis: An approach to support critical-infrastructure risk-assessment. *Reliability Engineering and System Safety*. **167**(2017): 198-217.
9. Boesch,, F.T., Satyanarayana, A., and Suffel, C.L. 2009. A survey of some network reliability analysis and synthesis results. *Networks*. **54**(2): 99-107.
10. Boldi, P., and Vigna, S. 2014. Axioms for Centrality. *Internet Mathematics*. **10**(2014): 222-262.
11. Camp, T.R., and Hazen, H.L. 1934. Hydraulic analysis of water distribution systems by means of an electric network analyzer. *JNEWWA*. **48**(1934): 383.

12. Candelieri, A., Soldi, D., and Archetti, F. 2015. Network analysis for resilience evaluation in water distribution networks. *Environmental Engineering & Management Journal (EEMJ)*. **14**(6): 1261-1270.
13. Cimellaro, G.P., Tinebra, A., Renschler, C. and Fragiadakis, M. 2016. New resilience index for urban water distribution networks. *Journal of Structural Engineering*. **142**(8): C4015014: 1-13.
14. Cross, H. 1936. Analysis of flow in networks of conduits or conductors. *Illinois Bulletin*. **286**: 1-32.
15. Diao, K., Sweetapple, C., Farmani, R., Fu, G., Ward, S., and Butler, D. 2016. Global resilience analysis of water distribution systems. *Water Research*. **106**(2016): 383-393.
16. Di Nardo, A., Di Natale, M., Giudicianni, C., Musmarra, D., Rodriguez Varela, J.M., Santonastaso, G.F., Simone, A., and Tzatchkov, V. 2017. Redundancy features of water distribution systems. *Procedia Engineering*. **186** (2017): 412-419.
17. Di Nardo, A., M., Giudicianni, C., Greco, R., Herrera, M., and Santonastaso, G.F. 2018. Applications of graph spectral techniques to water distribution network management. *Water*. **10** (1): 45, 1-16.
18. Dziedzic, R., and Karney, B.W. 2016. Performance index for water distribution networks under multiple loading conditions. *Journal of Water Resources Planning and Management*. **142**(1): 4015040.
19. Eusgeld, I., Nan, C., and Dietz, S. 2011. "System-of-systems" approach for interdependent critical infrastructures. *Reliability Engineering and System Safety*. **96**(2011): 679-686.
20. Fragiadakis, M., and Christodoulou, S.E. 2014. Seismic reliability assessment of urban water networks. *Engineering & Structural Dynamics*. **43**(3): 357-374.
21. Fragiadakis, M., Xanthos, S., Eliades, D.G., Gagatsis, A., and Christodoulou, S.E. 2016. Graph-based hydraulic vulnerability assessment of water distribution networks. *Lecture Notes in Computer Science Engineering & Structural Dynamics*. 8985: 81-87.
22. Freeman, J.R. 1892. The arrangement of hydrants and water pipes for the protection of a city against fire. *Journal of New England Water Works Associations*. **7**(1): 49-81.
23. Gheisi, A., and Naser, G. 2014. Water distribution system reliability under simultaneous multicomponent failure scenario. *Journal American Water Works Association*. **106**(7): E319-E327.



24. Giudicianni, C., Di Nardo, A., Di Natale, M., Greco, R., Santonastaso, G.F., and Scala, A. 2018. Topological taxonomy of water distribution networks. *Water*. **10** (4): 444,1-19.
25. Goulter, I.C. 1987. Current and future use of systems analysis in water distribution network design. *Civil Engineering Systems*. **4**(4): 175-184.
26. Greco, R., Di Nardo, A., and Santonastaso, G. 2012. Resilience and entropy as indices of robustness of water distribution networks. *Journal of Hydroinformatics*. **14**(3): 761-771.
27. Gupta, R., Baby, A., Arya, P.V., and Ormsbee, L. 2014. Segmented-based reliability/supply shortfall analysis of water distribution networks. *Procedia Engineering*. **89**(2014): 1168-1175.
28. Gupta, R., and Bhawe, P.R. 1994. Reliability analysis of water-distribution systems. *Journal of Environmental Engineering*. **120**(2): 447-461.
29. Gupta, R., Bhawe, P.R. 1996. Reliability-based design of water distribution systems. *Journal of Environmental Engineering*. **122**(1): 51-54.
30. Gupta, R., Lakshmi, B.Y., Sayyed, M.A., and Rathi, S. 2014. Comparison of flow distribution models for design of water distribution networks with redundancy. *Procedia Engineering*. **89**(2014): 848-855.
31. Herrera, M., Abraham, E., and Stoianov, I. 2016. A graph-theoretic framework for assessing the resilience of sectorised water distribution networks. *Water Resources Management*. **30**(5): 1685-1699.
32. Howland, W.E. 1934. Expansion of Freeman method for the solution of pipe flow problems. *JNEWWA*. **48**(1934): 408.
33. Jensen, H.A., and Jerez, D.G. 2018. A stochastic framework for reliability and sensitivity analysis of large scale water distribution networks. *Reliability Engineering and System Safety*. **176**(2018): 80-92.
34. Johansson, J., Hassel, H., and Zio, E. 2013. Reliability and vulnerability analyses of critical infrastructures: Comparing two approaches in the context of power systems. *Reliability Engineering and System Safety*. **120**(2013): 27-38.
35. Joyce, K., Laurienti, P.J., Burdette, J.H., and Hayasaka, S. 2010. A new measure of centrality for brain networks. *PLoS One*. **5**(8): e12200.

36. Jung, D., Kang, D., Kim, JH., and Lansey, K. 2014. Robustness-based design of water distribution networks. *Journal of Water Resources Planning and Management*. **140**(11): 04014033:1-14.
37. Kessler, A., Ormsbee, L., and Shamir, U. 1990. A methodology for least cost design of invulnerable water distribution networks. *Civil Engineering Systems*. **7**(1): 20-28.
38. Laucelli, P., and Giustolisi, O. 2015. Vulnerability assessment of water distribution networks under seismic actions. *Journal of Water Resources Planning and Management*. **141**(6):1-13.
39. Lawyer, G. 2015. Understanding the influence of all nodes in a network: a continuous time-perspective. *Scientific Reports*. **5**(2015): 8665:1-9.
40. Liu, H., Savic, D.A., Kapelan, Z., Creaco, E., and Yuan, Y. 2017. Reliability surrogate measures for water distribution system design: Comparative analysis. *Journal of Water Resources Planning and Management*. **143**(2): 04016072.
41. Maiolo, M., Pantusa, D., Carini, M., Capano, G., Chiaravollati, F., and Procopio, A. 2018. A new vulnerability measure for water distribution network. *Water*. **10** (8): 1005,1-19.
42. Mala-Jetmarova, H., Barton, A.F., and Bagirov, A. 2015. A history of water distribution systems and their optimisation. *Water Science and Technology*. **15**(2): 224-235.
43. Mala-Jetmarova, H., Sultanova, N., and Savic, D. 2018. Lost in optimisation of water distribution systems? A literature review of system design. *Water*. **10**(3): 307.
44. Mays, L.W., and Cullinane, J. 1986. A review and evaluation of reliability concept for design of water distribution systems. *No.WES/MP/EL-86-1. U.S Army Engineer Waterways Experiment Station, Vicksburg MS Environmental Lab*.
45. Mays, L.W., Sklivaniotis, M., and Angelakis, A.N. 2012. Water for human consumption through history. In Angelakis, A.N., Mays, L.W., Koutsoyiannis, D., and Mamassis, N. (Eds). *Evolution of Water Supply Through the Millennia*. IWA Publishing, London, UK: 19-42.
46. Mcilroy, M.S. 1950. Direct-reading electric analyzer for pipeline networks. *Journal of American Water Works Association*. **42**(4): 347-366.
47. Meng, F., Guangtao, F., Farmani, R., Sweetapple, C., and Butler, D. 2018. Topological attributes of network resilience: A study in water distribution systems. *Water Research*. **143**(2018): 376-386.

48. Murray, A.T., and Grubestic, T.H. 2007. Critical Infrastructure Reliability and Vulnerability. In Murray, A.T., and Grubestic, T.H (Eds). *Overview of Reliability and Vulnerability Critical Infrastructure*. Springer-Verlag, Heidelberg, Berlin, Germany:1-8.
49. O'Connor, P.D.T. 2000. Commentary: Reliability- Past, Present, and Future. *International Transactions on Reliability*. **49**(4): 335-341.
50. Ormsbee, L., Kessler, A. 1990. Optimal upgrading of hydraulic network reliability. *Journal of Water Resources Planning and Management*. **116**(6): 784-802.
51. Pagano, A., Puchinotta, I., Giordano, R., and Fratino, U. 2018. Integrating “Hard” and “Soft” infrastructural resilience assessment for water distribution systems. *Complexity*. **2018**: 3074791, 1-16.
52. Prasad, T.D., and Park, N.S. 2004. Multiobjective genetic algorithms for design of water distribution networks. *Journal of Water Resources Planning and Management*. **130**(1): 73-82.
53. Perelman, L., and Ostfeld, A. 2011. Topological clustering for water distribution systems analysis. *Environmental Modelling and Software*. **26**(7): 969-972.
54. Rao, M.S. and Naikan, V.N.A. 2016. Review of simulation approaches in reliability and availability modeling, *International Journal of Performability Engineering*. **12**(4):369-388.
55. Sarbu, I. 2014. Nodal analysis of urban water distribution networks. *Water Resources Management*. **28**(10): 3143-3159.
56. Scardoni, G., Motrelor, A., Tosadori, G., and Laudanna, C. 2014. Node interference and robustness: performing virtual knock-out experiments on biological networks: The case of leukocyte integrin activation network. *PLoS ONE*. **9**(2): 1-10.
57. Shamir, U., and Howard, C. 1968. Water distribution systems analysis. *Journal of the Hydraulics Division*. **94**(1968): 219-234.
58. Sheng, N., Jia, Y., Xu, Z., Ho, S.L., and Kan, C.W. 2013. A complex network based model for detecting isolated communities in water distribution networks. **23**(4): 043102.
59. Shuang, Q., Zhang, M., and Yuan, Y. 2014. Node vulnerability of water distribution networks under cascading failures. *Reliability Engineering and System Safety*. **124**(2014): 132-141.

60. Shuang, Q., Liy, Y., Tang, Y., Liu, J., and Shuang, K. 2017. System reliability evaluation in water distribution networks with the impact of valves experiencing cascading failures. *Water*. 9(6), 413:1-17.
61. Singh, V.P., and Oh, J. 2015. A Tsallis entropy-based redundancy measures for water distribution networks. *Physica A: Statistical Mathematics and its Application*. 421(2015): 360-376.
62. Spiess, O.V. 1887. Graphische losung von hydraulischen aufgaben. *Journal fur Gasbeleuchtung und Wasserversorgung*. 17(1887): 563-574.
63. Spiliotis, M., and Tsakiris, G. 2010. Water distribution system analysis: Newton-Raphson method revisited. *Journal of Hydraulic Engineering*. 137(8): 852-855.
64. Tanyimboh, T.T., Siew, C., Saleh, S., and Czajkowska, A. 2016. Comparison of surrogate measures for the reliability and redundancy of water distribution systems. *Water Resources Management*. 30(10): 3535-3552.
65. Taylor, M.A.P., Sekhar, S.V.C, and D'Este, G. 2006. Application of accessibility based methods for vulnerability analysis of strategic road networks. *Networks and Spatial Economics*. 6(3-4):267-291.
66. Todini E. 2000. Looped water distribution networks design using a resilience index based heuristic approach. *Urban Water*. 2(2): 115-122.
67. Trucco, P., Cagno, E., and De Ambroggi, M. 2012. Dynamic functional modelling of vulnerability and interoperability of critical infrastructures. *Reliability Engineering and System Safety*. 105(2012): 51-63.
68. Ulusoy, A.J., Stoianov, I., and Chazerain, A. 2018. Water distribution reliability: Analytical methods. *Applied Network Science*. 3(1): 31.
69. Wagner, J.M., Shamir, U., and Marks, D.H. 1988. Water distribution reliability: Analytical methods. *Journal of Water Resources Planning and Management*. 114(3): 253-275.
70. Wright, R., Abraham, E., Pappas, P., and Stoianov, I. 2015. Control of water distribution networks with dynamic DMA topology using strictly feasible sequential convex programming. *Water Resources Research*. 51(12): 9925-9941.
71. Wu, L., Tan, Q. and Zhang, Q. 2013, Network connectivity entropy and its application on network connectivity reliability, *Physica A: Statistical Mechanics and its Applications*. 392(21): 5536-5541.

72. Yazdani, A., and Jeffrey, P. 2011. Complex network analysis of water distribution systems. *Chaos: An Interdisciplinary Journal of Nonlinear Science*. **21**(1): 016111.
73. Yazdani, A., and Jeffrey, P. 2012a. Applying network theory to quantify the redundancy and structural robustness of water distribution systems. *Journal of Water Resources Planning and Management*. **138**(2): 153-161.
74. Yazdani, A., and Jeffrey, P. 2012b. Water distribution system vulnerability analysis using weighted and directed network models. *Water Resource Research*. 48(6), 2012 b.
75. Yazdani, A., Otoo, R.A., and Jeffrey, P. 2011. Resilience enhancing expansion strategies for water distribution systems: A network theory approach. *Environmental Modelling and Software*. **26**(12): 1574-1582.
76. Zhuang, B., Lansey, K., and Kang, D. 2013. Resilience/availability analysis of municipal water distribution system incorporating adaptive pump operation. *Journal of Hydraulic Engineering*. **139**(5): 527-538.